







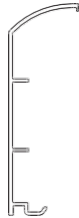

Ultima AlProtect

Karakteristike sistema System characteristics

- Ugradna mera 70/76 mm
- Kombinacija spoljne aluminijumske obloge i unutrašnjeg PVC profila
- Dugotrajan i dopadljiv izgled
- Kvalitet kao kod aluminijumskih prozora
- Neograničen izbor boja

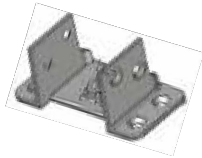

- Base width 70/76mm
- Combination of aluminum external look and interior PVC decor
- High durability and spectacular aesthetic appearance
- Extraordinary thermal insulation compared to aluminum windows
- Unlimited color options and combinations

[IFRA CODE	O pis Description	Profil Profile	[IFRA CODE	O pis Description	Profil Profile
A1011	Aluminijumska obloga za {tok Aluminium cover for frame		1101 32 mm	Lajsna za staklo Glassbead	
Ultima AlProtect			Ultima AlProtect		
A2011	Aluminijumska obloga za krilo Aluminium cover for sash		1003 36 mm	Lajsna za staklo Glassbead	
Ultima AlProtect			Ultima AlProtect		
A3011	Aluminijumska obloga za „T“ pre-ku Aluminium cover for mullion		1007 24 mm	Lajsna za staklo Glassbead	
Ultima AlProtect			Ultima AlProtect		
A4011	Aluminijumska obloga za srednju dopunu Aluminium cover for overhung			Guma Rubber	 
Ultima AlProtect			Ultima AlProtect		GA01 GA02
1012	Spojnica za „T“ profil Metal mullion connector				
Ultima AlProtect					

A1011

Aluminijumska obloga za {tok
Aluminium cover for frame

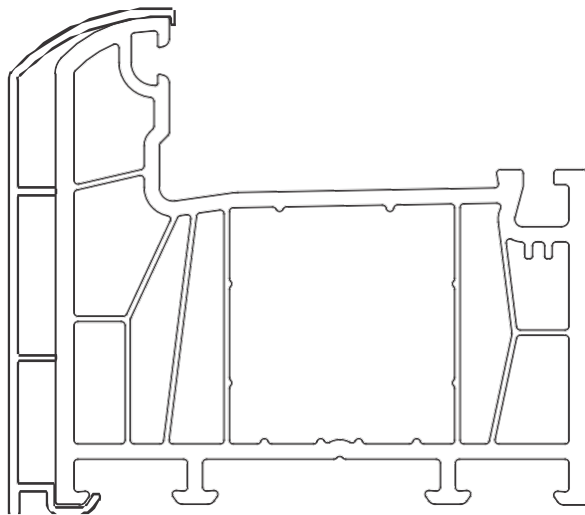

A2011

Aluminijumska obloga za krilo
Aluminium cover for mullion

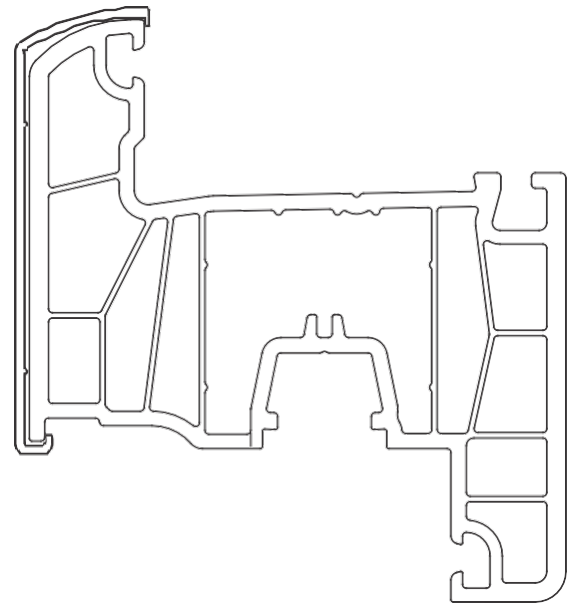

A3011

Aluminijumska obloga za „T“ profil
Aluminium cover for sash

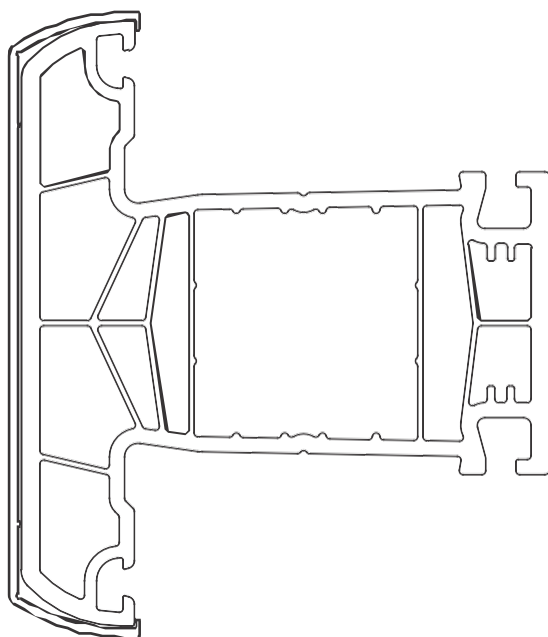

A4011

Aluminijumska obloga za srednju dopunu
Aluminium cover for overhung

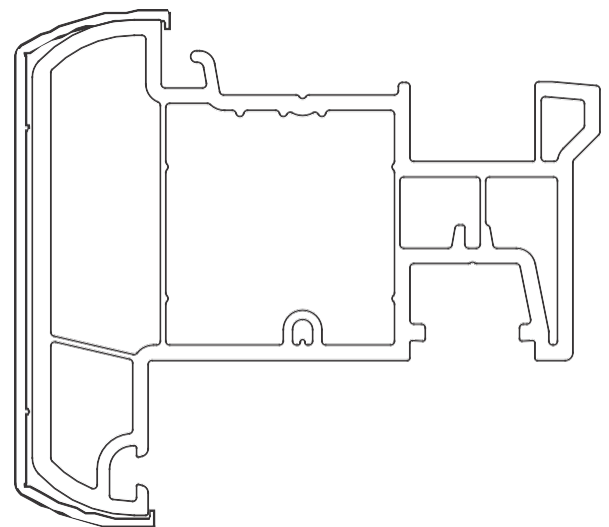

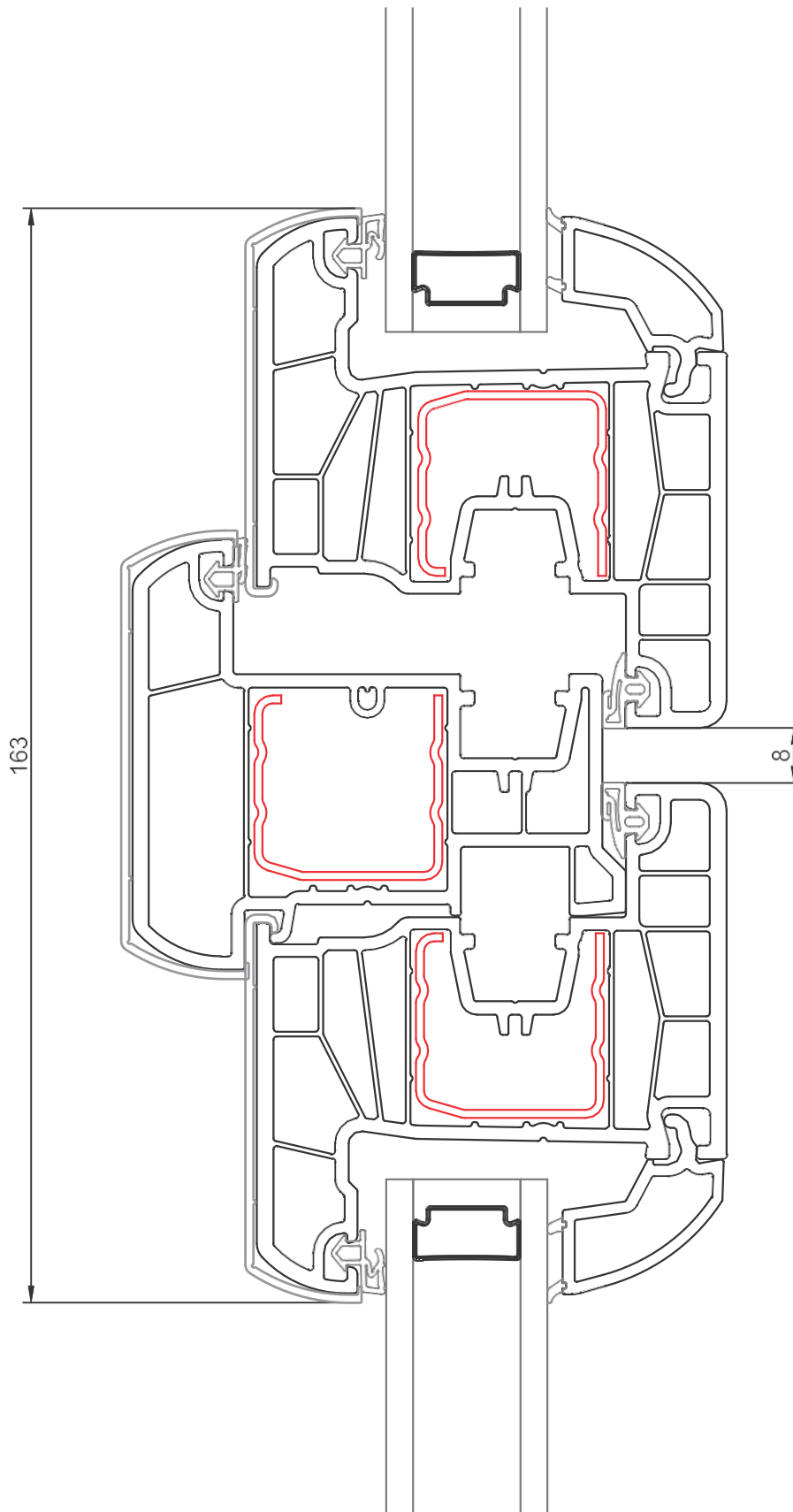

M 1:1
Razmera
Cutting out

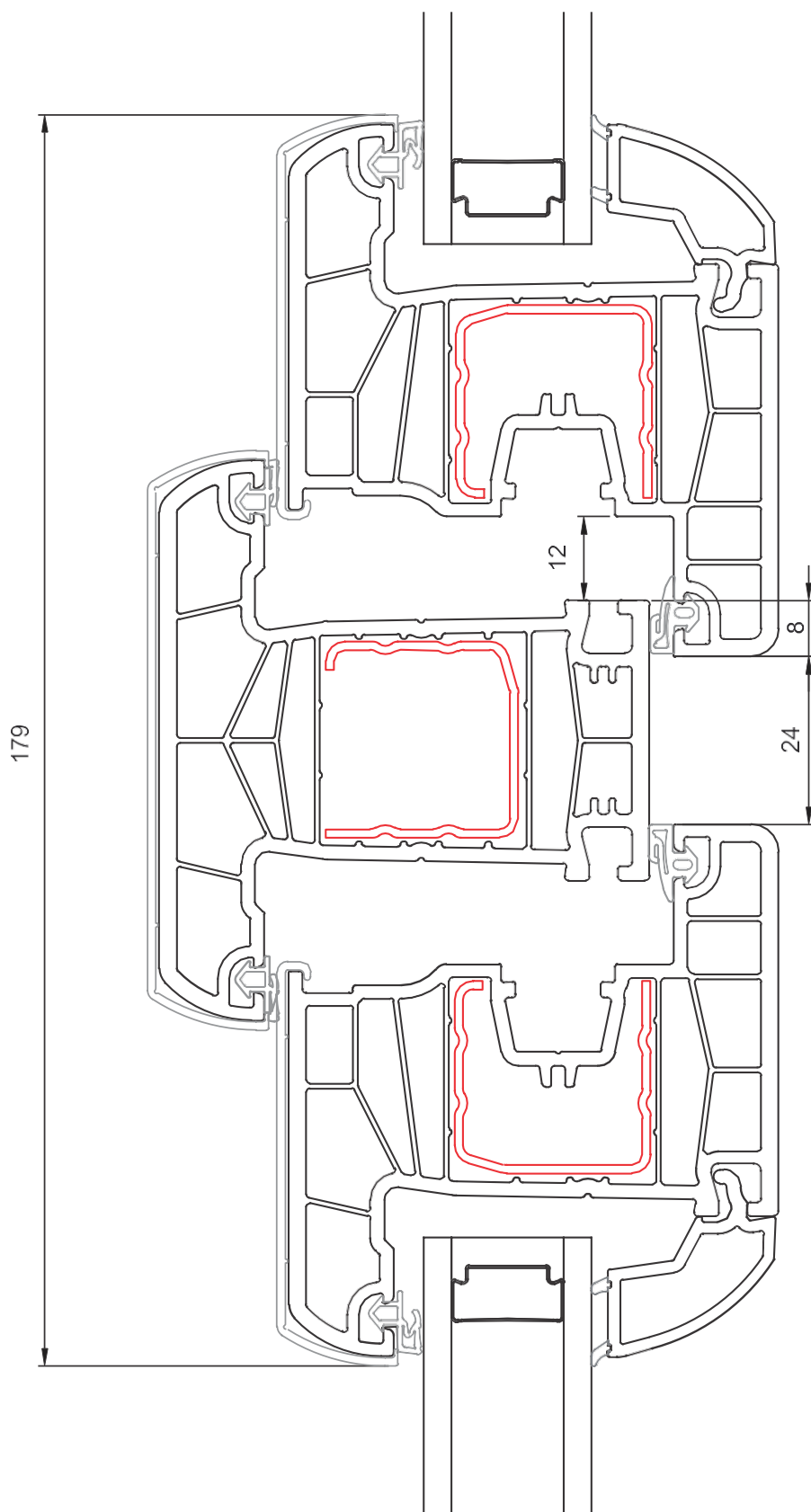

M 1:1
Razmera
Cutting out