

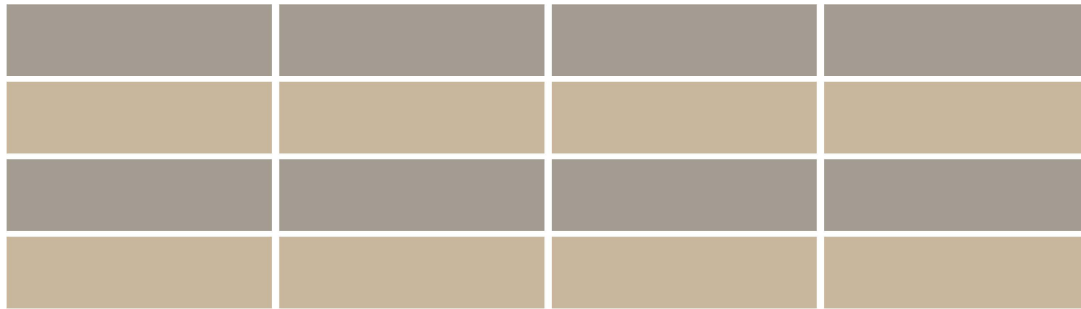

SARAY®

Aluminium Cotta Design



COLORS

New Collection

Aluminium Linear Design



SARAY®

PROAL

COTTA DESIGN



***The First In The World !
Ceramic Tile or Brick Look Aluminium Facade Systems***

Patent No: 2008 / 01925

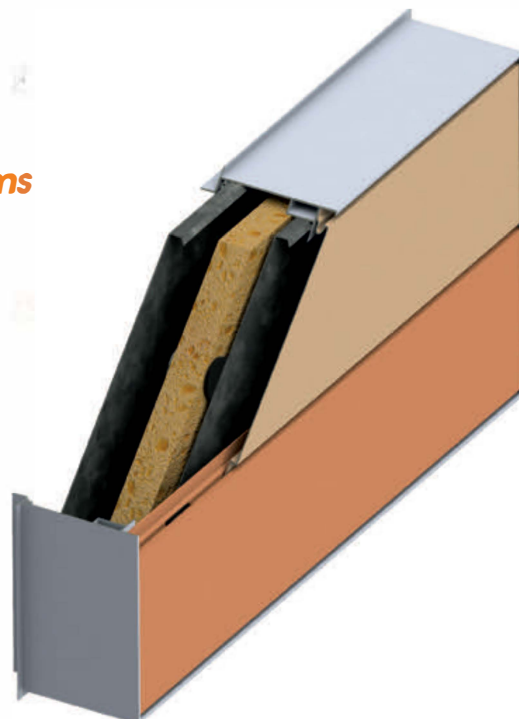
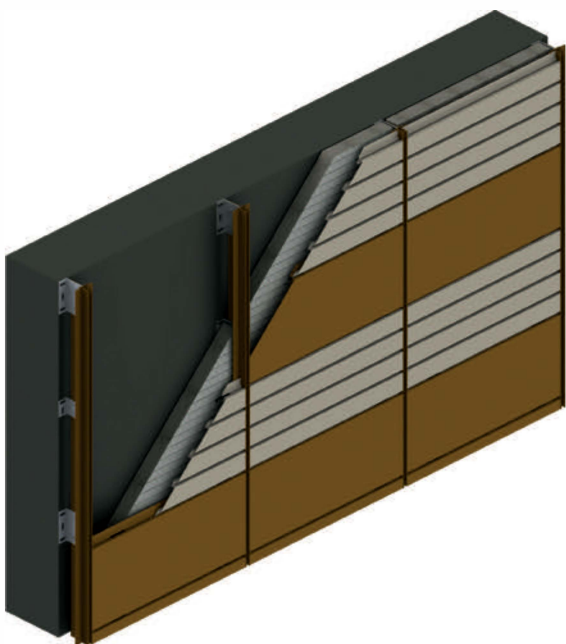

***With SARAY COTTA,
coating of your facade is under warranty of
international QUALICOAT certificate for many years***

New generation material for facade SARAY COTTA DESIGN

In comparison to ceramic tile cladding, SARAY COTTA DESIGN has an advantage on labor cost, and time

With approximately 8 KGs of aluminium used per 1 m², SARAY COTTA DESIGN increases the static strength of the structure

Coating with QUALICOAT technology, SARAY COTTA DESIGN is dirt-repellent, nonfading and ageless.

As an extruded profile, SARAY COTTA DESIGN is fire resistant and eco-friendly product.

Since it's not a baked clay product, SARAY COTTA DESIGN can be produced in requested dimension according to the architectural structure and facade.

In addition to the standard color chart, SARAY COTTA DESIGN can be coated with desired color for special projects. SARAY COTTA DESIGN is an A2 degree of incombustible material, thus it's preferred in any kind of buildings.

SARAY Architectural Systems aims to offer solutions to all architectures with it's advanced R&D department and hi-tech production, all the new designs & solutions are architectural value. It works to offer the best product and service with total quality management.

SARAY®

PROAL

LINEAR DESIGN



With SARAY Linear Design, cladding can be done with desired color and length.

It's under warranty of international A2 standards

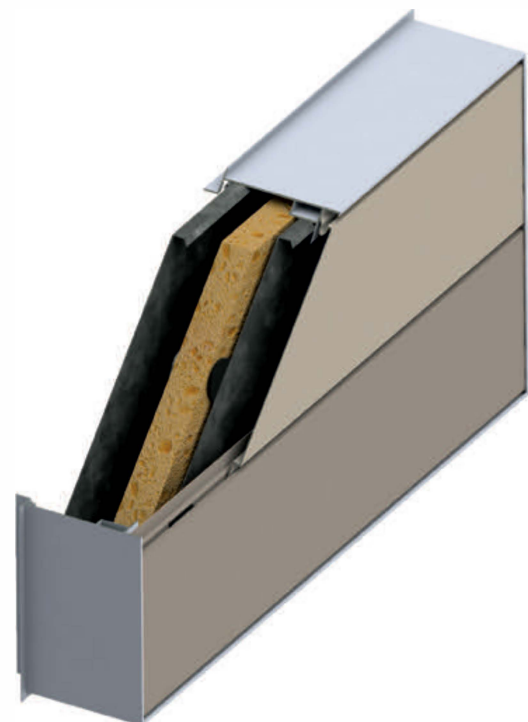

Quick and Easy Assembly Aluminium Cladding System

SARAY SIDING - New Generation Cladding

It's an alternative cladding material for cold and blind spots of the facade. It's aesthetic and economic. Profiles can be installed in desired color and length.

The colors in this catalogue is the most preferred Linear Design colors. It can be coated in desired color. The difference from Cotta Design is that Linear Design doesn't have vertical profiles.

In order to avoid stretching on the back, it has a hidden support and continuous linear view. Depending on the project, it can be installed horizontally or vertically.

With Saray Linear Design, facades have aesthetic and economic solutions.

Thanks to it's fast installation method, it saves time of the architects and contractors. Another specialty of this system is, it can processed and installed at the construction yard.

Being an A2 degree of incombustible material, having unlimited color options, not fading of the color makes Saray Linear Desing preferred in comparison to PVC based Siding materials.

SARAY®

PROAL

Renkler / Colors



C 622



C 625

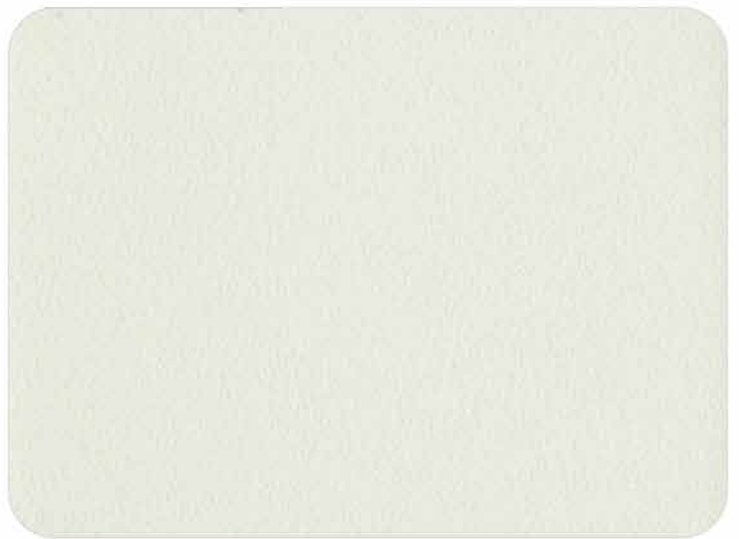

C 616

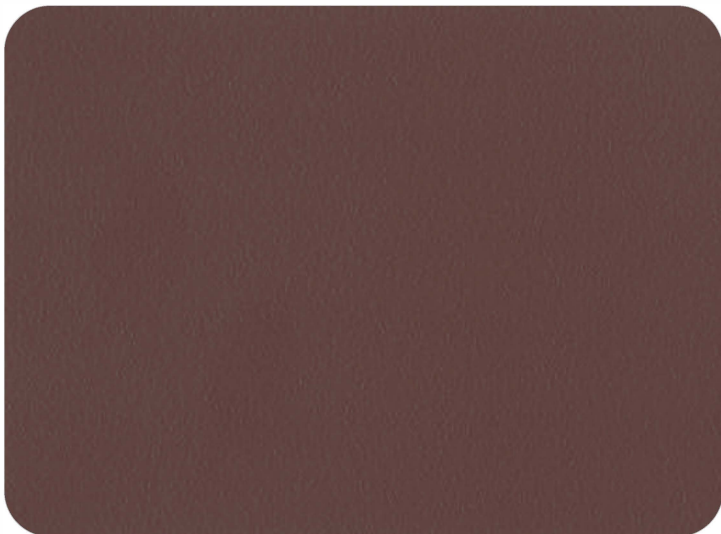

C 620



C 617

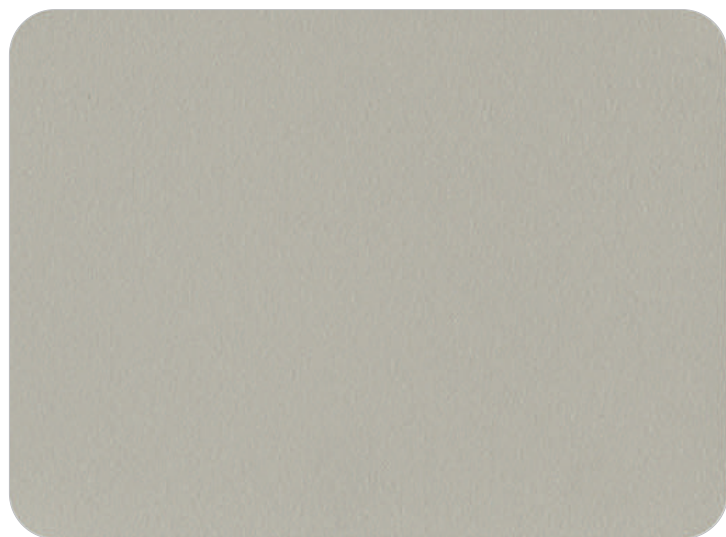

C 935

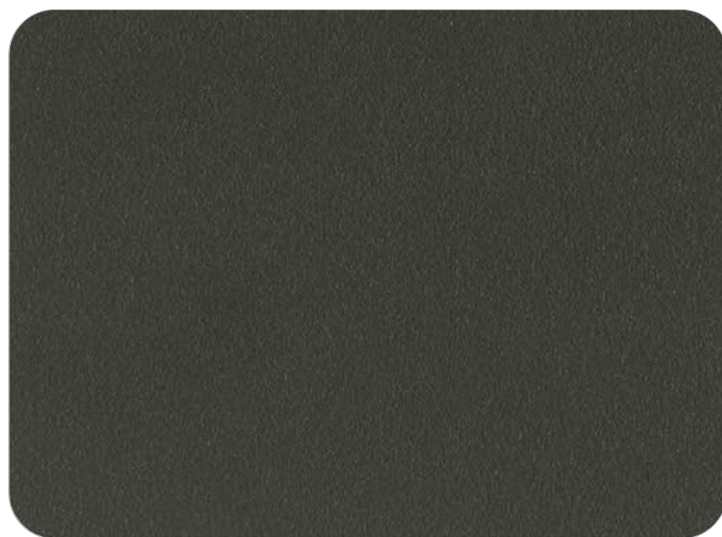

C 913

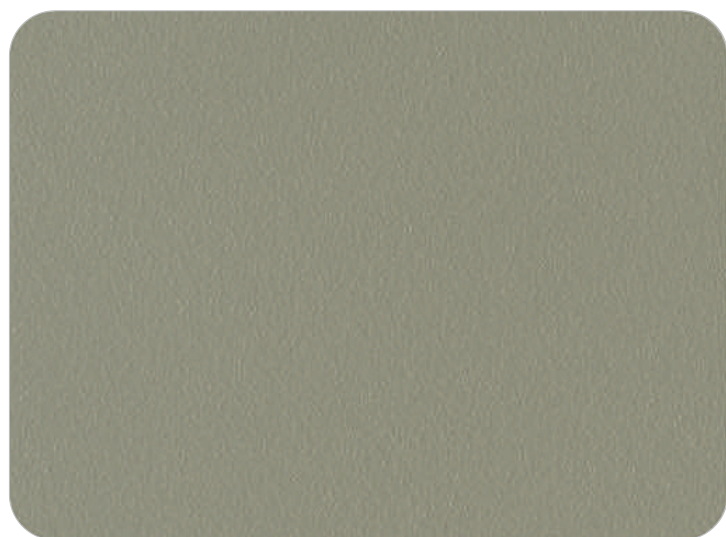

C 967

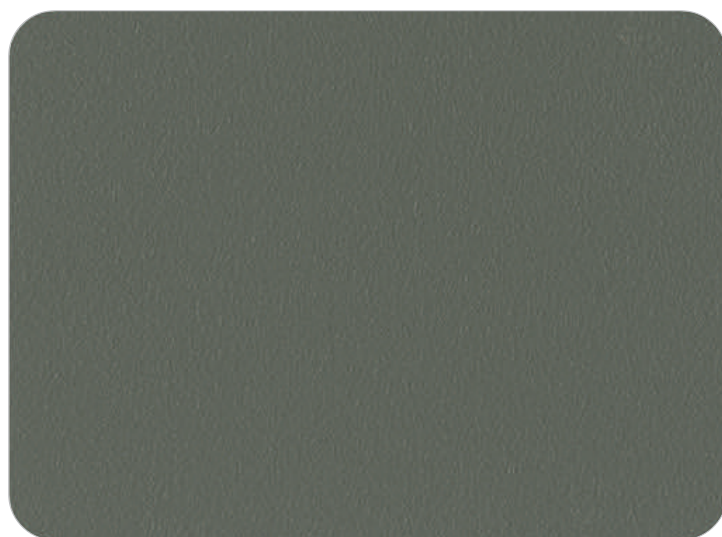

C 939

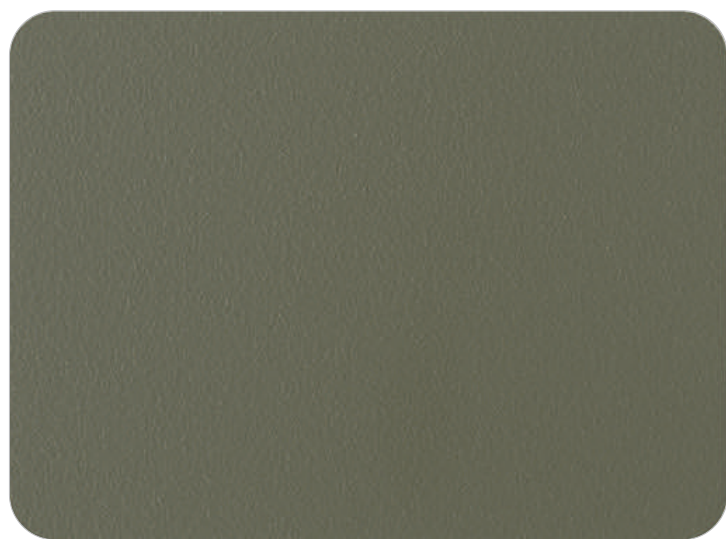

C 906





Maple M 9410



Light Walnut M 9310



Dark Oak M 9446



Dark Walnut M 7163



Chery M 9405

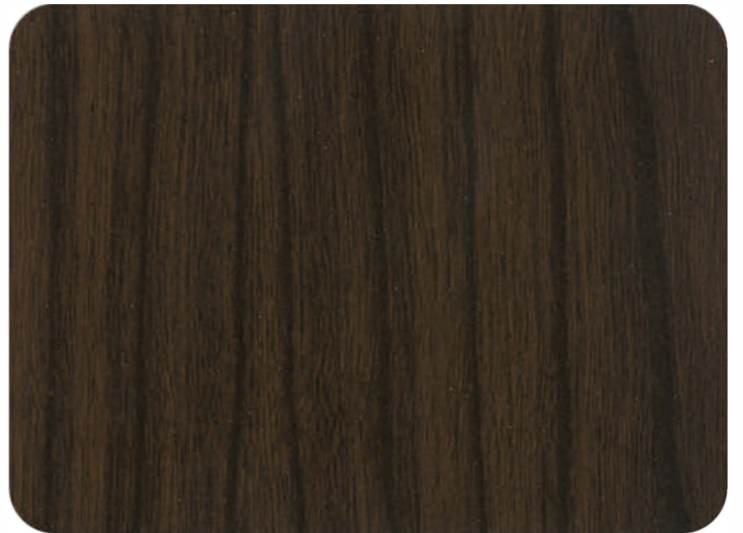

Light Wenge M 9396



Afromoza Teak 93093

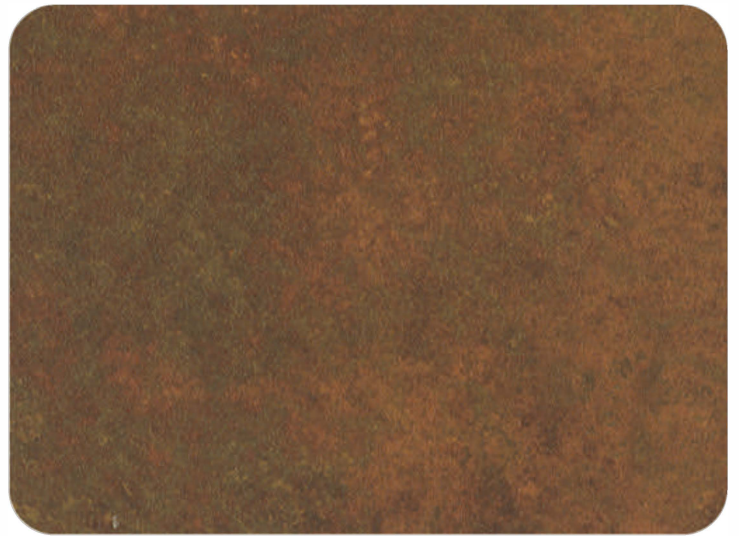

Corten 93092



Gold Oak 5131



Teak 3181

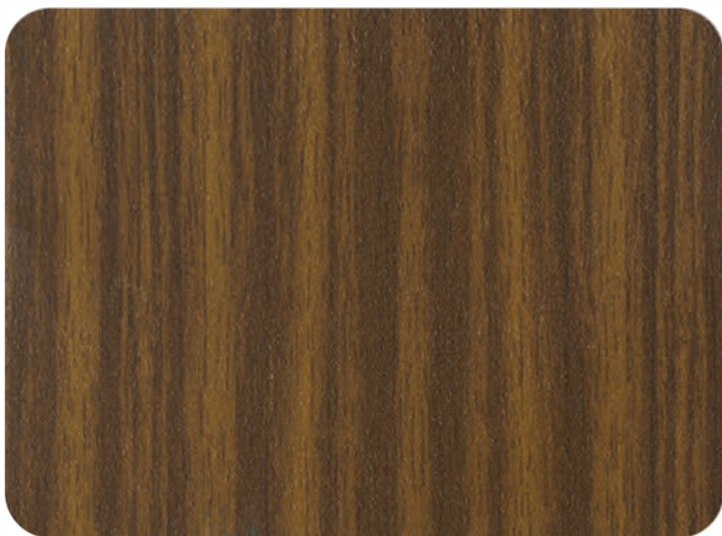

Oak 9111



Linear Design

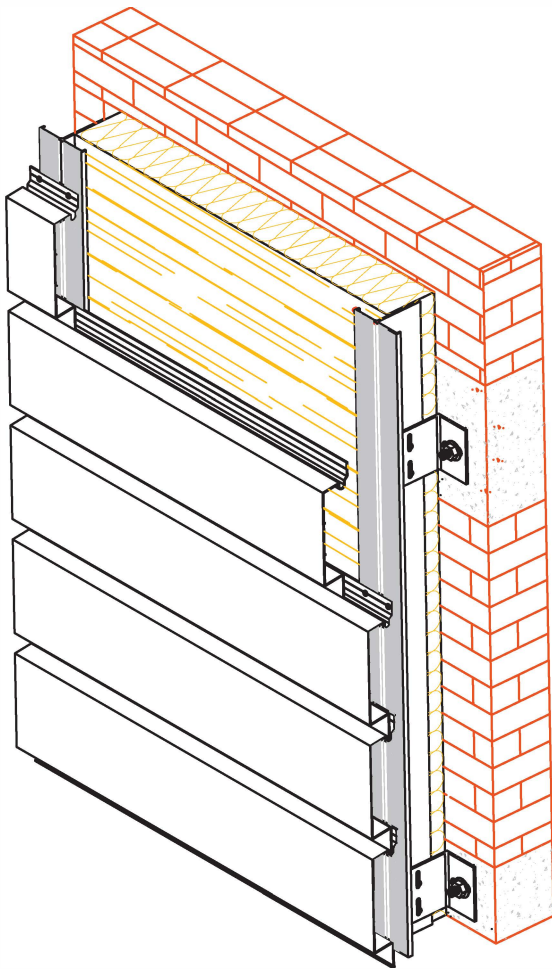

Cotta Design

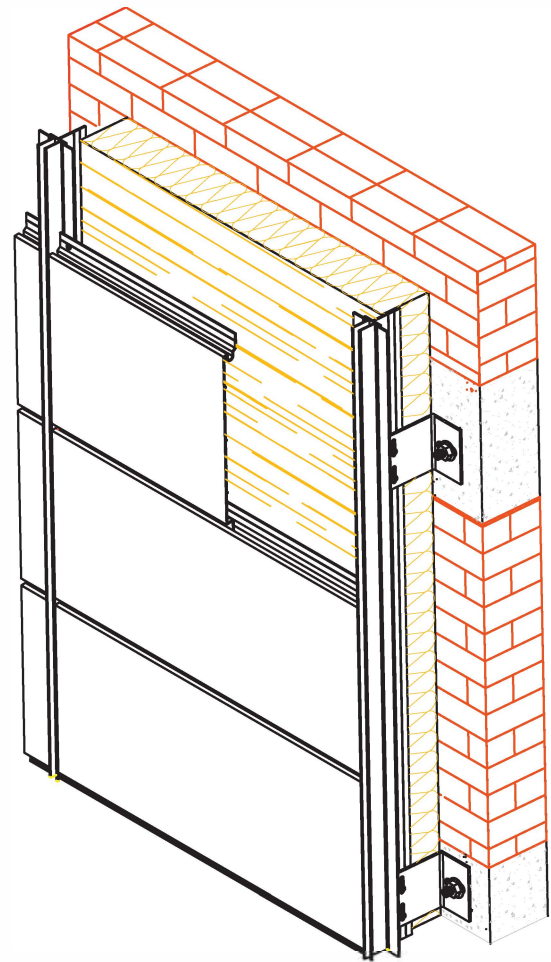

Profiles

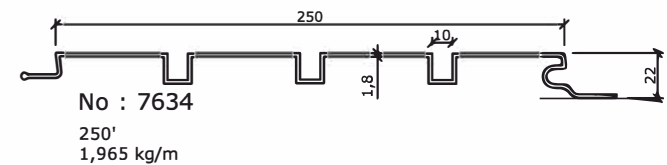
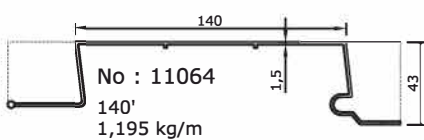
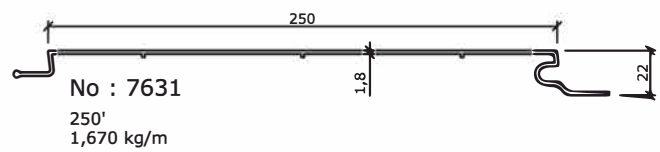
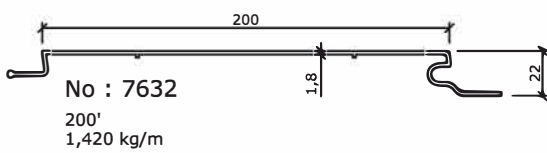
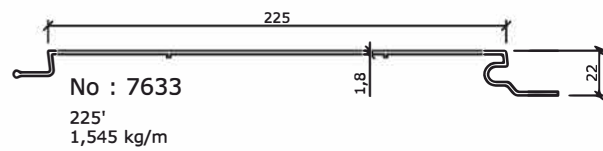
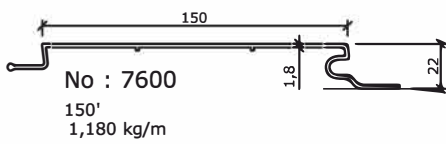

Warning: Our Profile weights are theoretically can be differ

Carrier T Profile

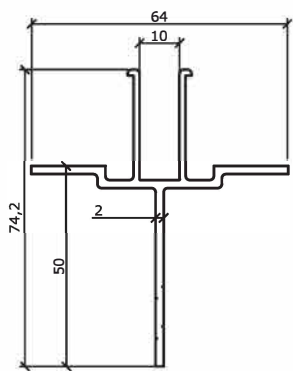

No : 7601

0,870 kg/m $J_x = 8,92 \text{ cm}^4$
 $J_y = 4,97 \text{ cm}^4$

Carrier Profile

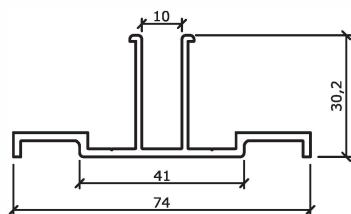

No : 7857

0,730 kg/m

Out Angle Corner Profile

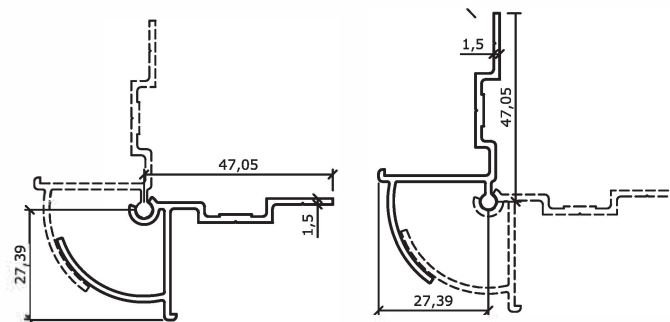

No : 7635

0,535 kg/m

No : 7636

0,505 kg/m

Bottom Finishing Profile

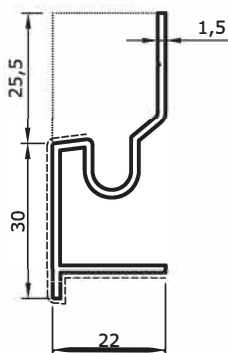

No : 7645

0,450 kg/m

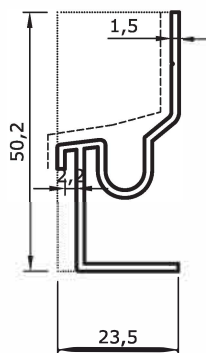

*No : 12192

0,430 kg/m

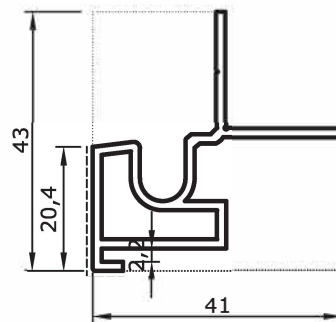

*No : 12193

90°
0,545 kg/m

L Support Carrier Profile

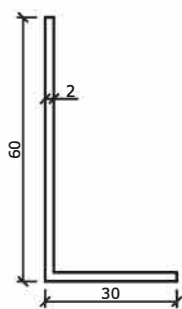

No : 1306

0,480 kg/m

$J_x = 7,27 \text{ cm}^4$
 $J_y = 0,77 \text{ cm}^4$

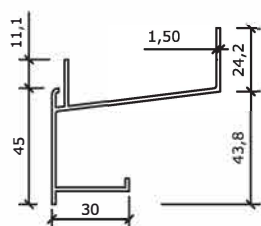

No : 8269

0,750 kg/m

In Angle Corner Profile

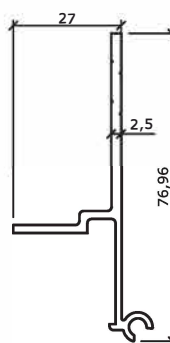

No : 7774

0,650 kg/m

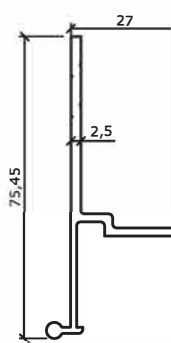

No : 7775

0,635 kg/m

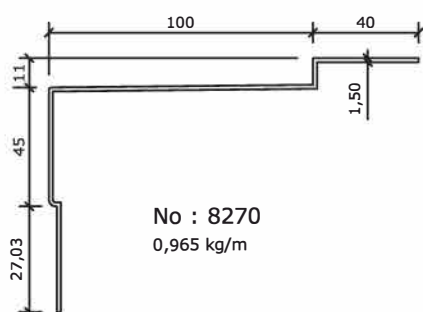

No : 8270
0,965 kg/m

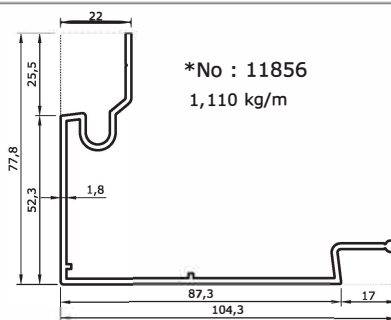

*No : 11856
1,110 kg/m

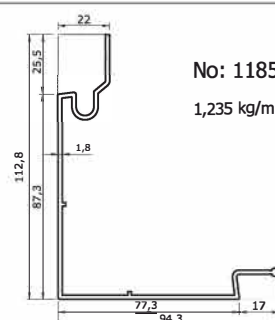

No: 11857
1,235 kg/m

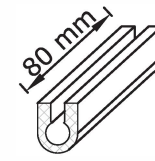
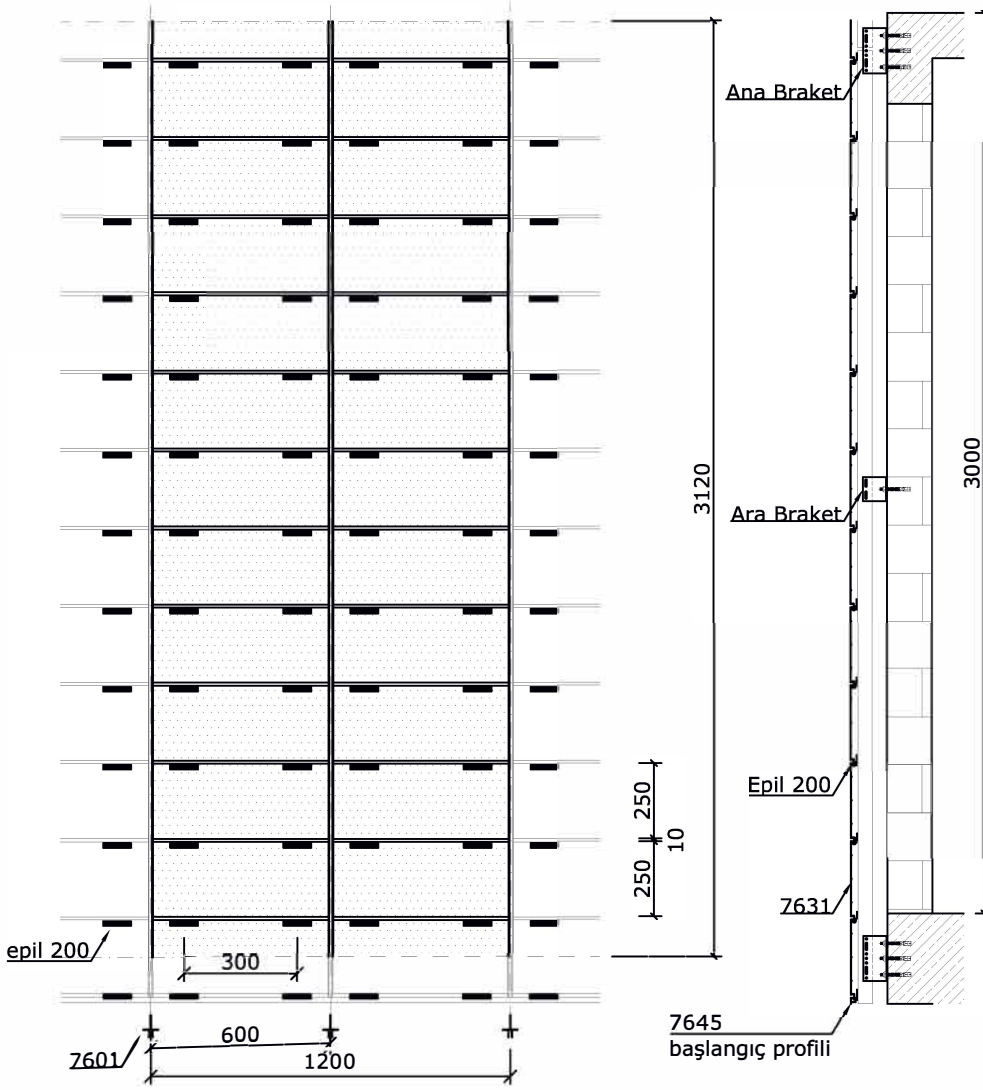

Epil 200
EPDM
(300 m) U Gasket

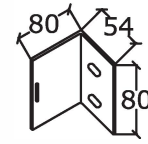

SC-526-80
Aluminium
L 80/80
L Bracket 80/80

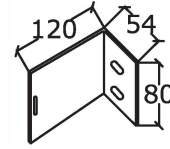

SC-527-80
Aluminium
L 120/80
L Bracket 120/80

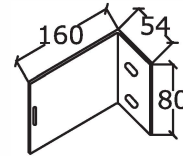

SC-528-80
Aluminium
L 160/80
L Bracket 160/80

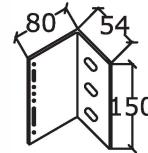

SC-526-150
Alüminyum
L Ana Braket 80/150
L Bracket 80/150

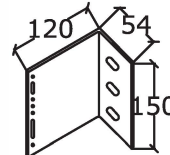

SC-527-150
Aluminium
L 120/150
L Bracket 120/150

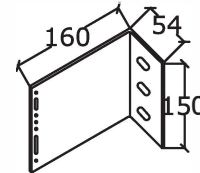

SC-528-150
Aluminium
L 160/150
L Bracket 160/150

SARAYCOTTA ANALİZE			
(1,20mx3,12m=3,744 m2 için) (1m2=7,72 kg)			
7601	0,870 kg/m	6,240 m (3,12 m x 2 peac)	5,43 kg
7631 250'	1,670 kg/m	14,064 m (0,586 mx24 peac)	23,49 kg
80x150 Bracket	3 pcs	1 peac	3 pcs
80x 80 Bracket	3 pcs	1 peac	3 pcs
Epil 200	2 pcs	24 peac	48 pcs
4,8x15 mm	3x3=9 ad (Ana braket) 3x1=3 ad (Ara braket)	9 ad+3	12 pcs
Stainless steel dowel	3x2=6 ad (Ana braket) 3x1=3 ad (Ara braket)	9 ad+3	12 pcs

Out Corner Detail

Out Corner Turn

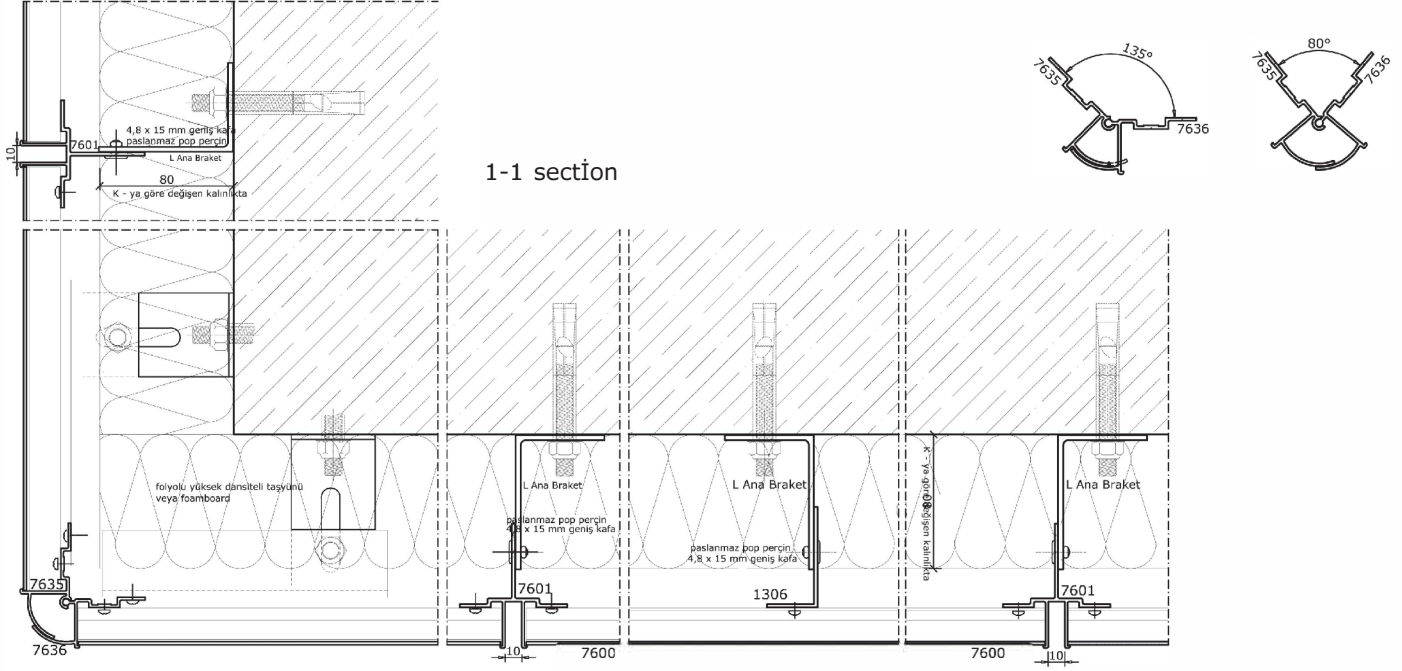

Assembly to metal construction

In Corner Turn

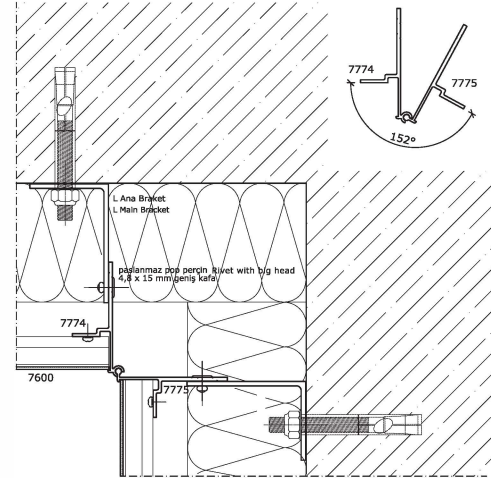
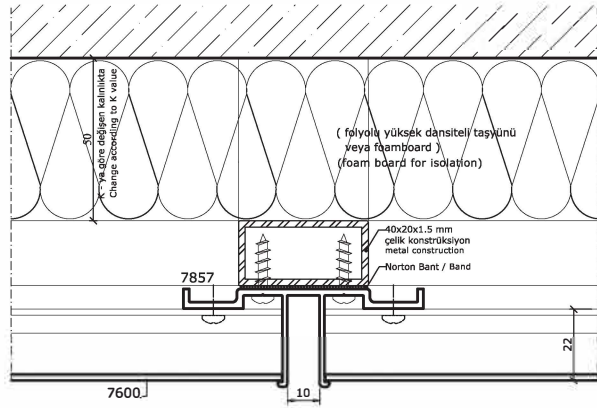

Finished Detail

Side

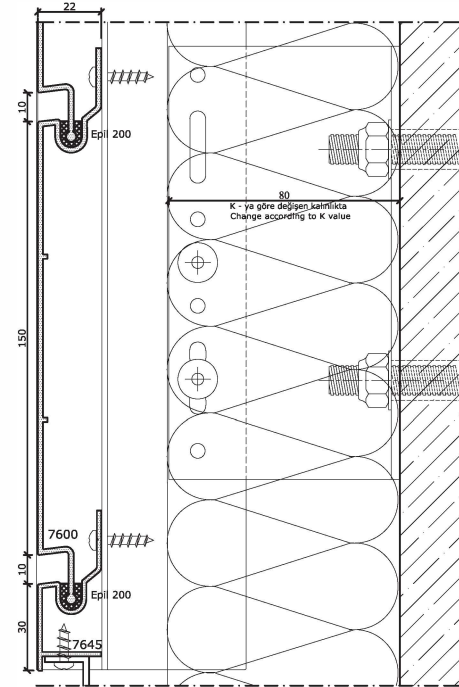
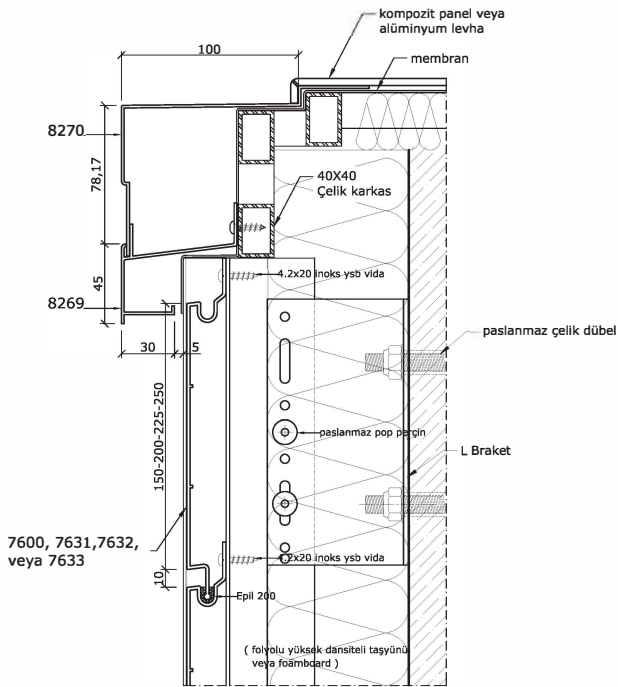



Colors Your World Timber Shades of Grey Internal Cladding Innovation Patented
First In The World! Decorative Aluminium Composite Panel Quality Approved Elegant
Saray Linear Design Aesthetic QUALICOAT Weathered Environmentally Friendly Aluminium Siding
Saray Cotta Design GREEN Building Exclusive Durable
Aluminium Siding High Gloss Colorful archITECTural Solutions Certified Solid
Saray Siding Ultra Matt Sustainability Textured Perfection Antigraffiti A2 Degree External Cladding
Non Combustible Elegant Distinctive Natural Wood Lamination Saray
Saray New Generation Ease of Assembly Facade Ease of Assembly Dynamic Anodized