

**206**

80' Vertikala  
2,235 kg/m  
 $J_x = 82,75 \text{ cm}^4$   
 $J_y = 23,94 \text{ cm}^4$

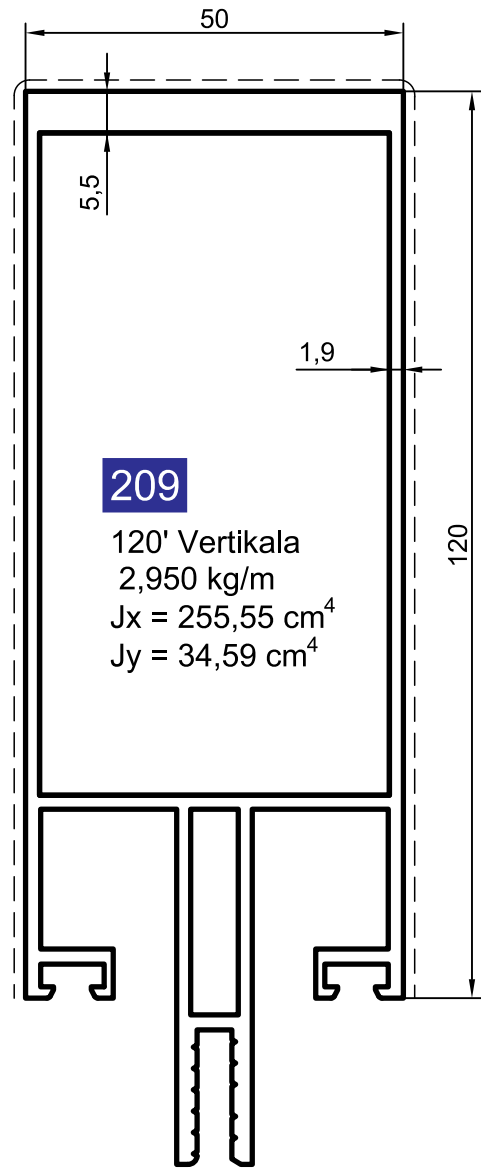

**209**

120' Vertikala  
2,950 kg/m  
 $J_x = 255,55 \text{ cm}^4$   
 $J_y = 34,59 \text{ cm}^4$

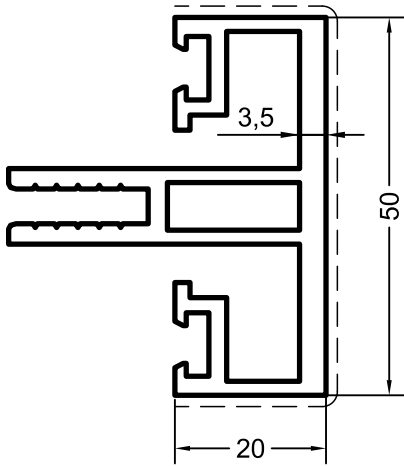

**210**

Vertikalna za krov  
1,470 kg/m  
 $J_x = 7,52 \text{ cm}^4$   
 $J_y = 10,43 \text{ cm}^4$

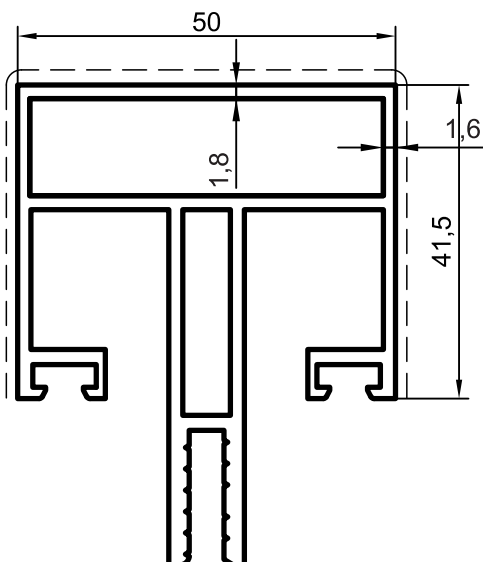

**288**

41' Vertikala  
1,580 kg/m  
 $J_x = 19,57 \text{ cm}^4$   
 $J_y = 13,29 \text{ cm}^4$

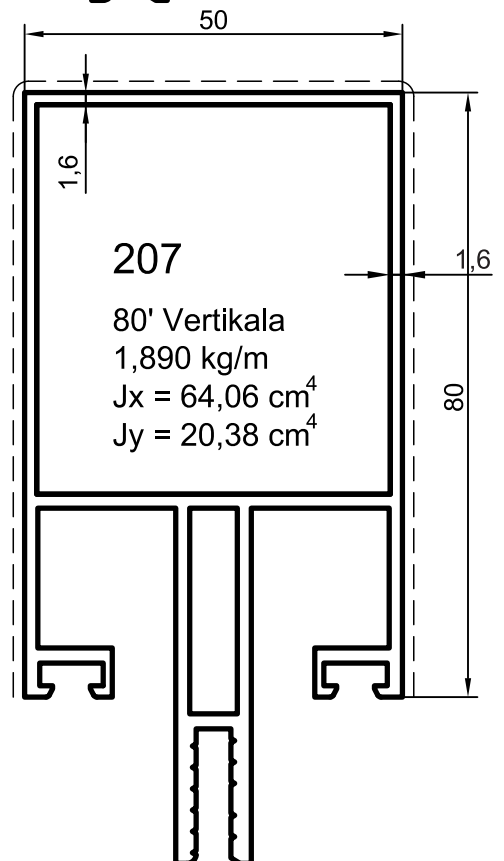

**207**

80' Vertikala  
1,890 kg/m  
 $J_x = 64,06 \text{ cm}^4$   
 $J_y = 20,38 \text{ cm}^4$

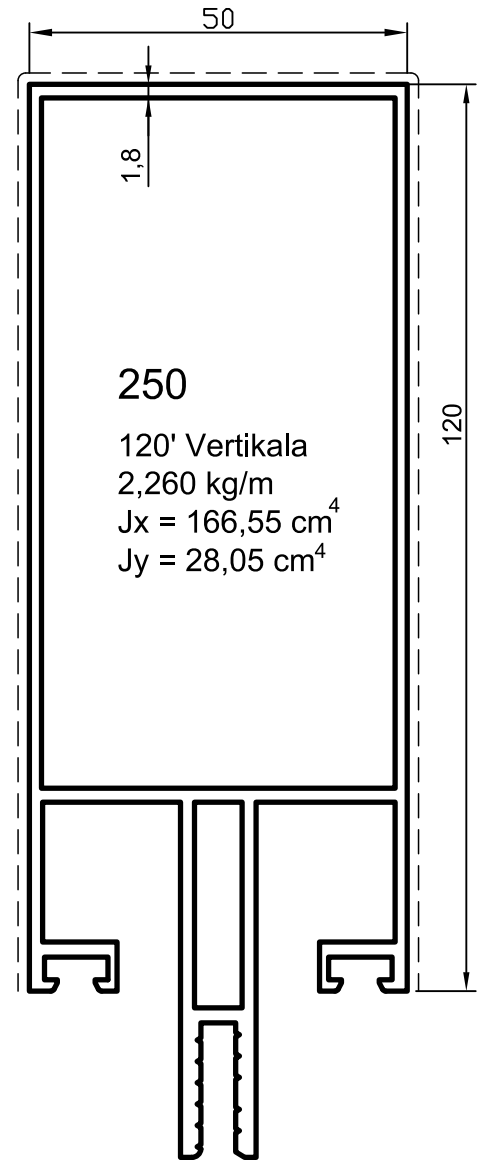
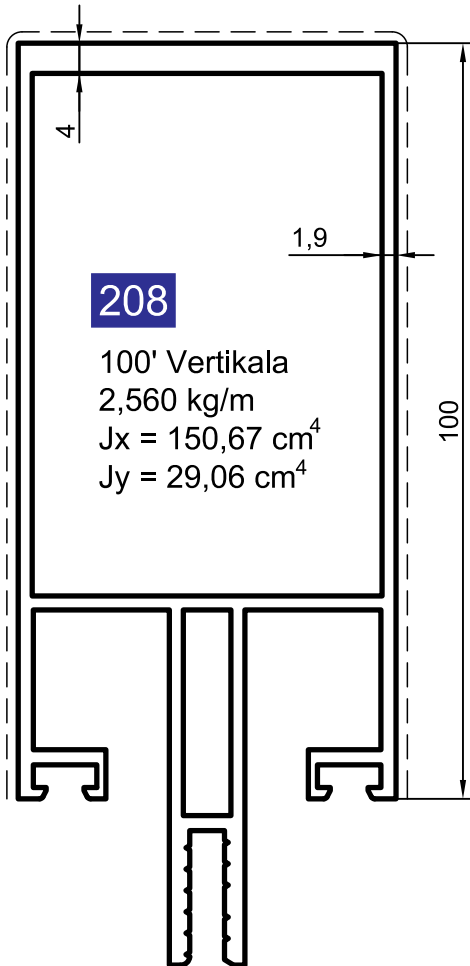
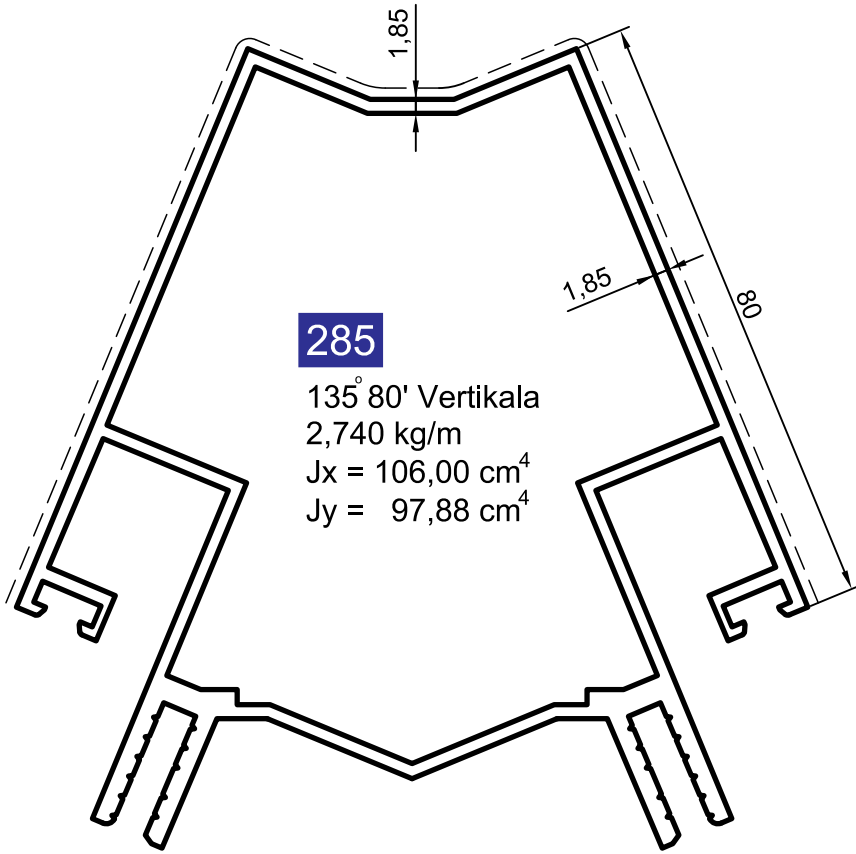

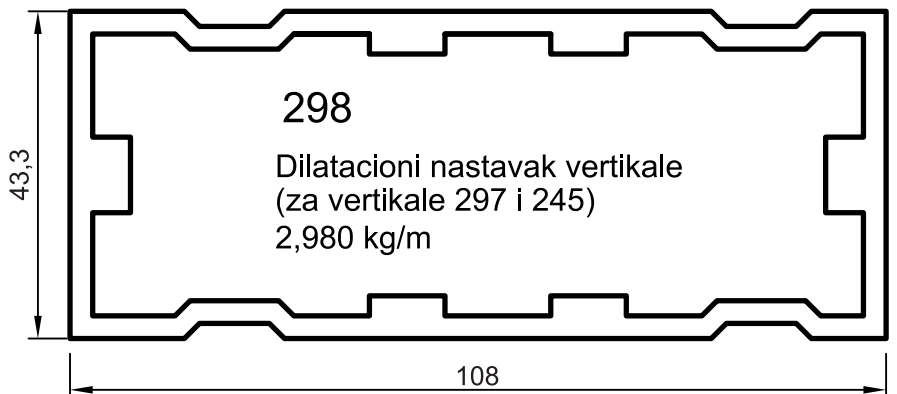
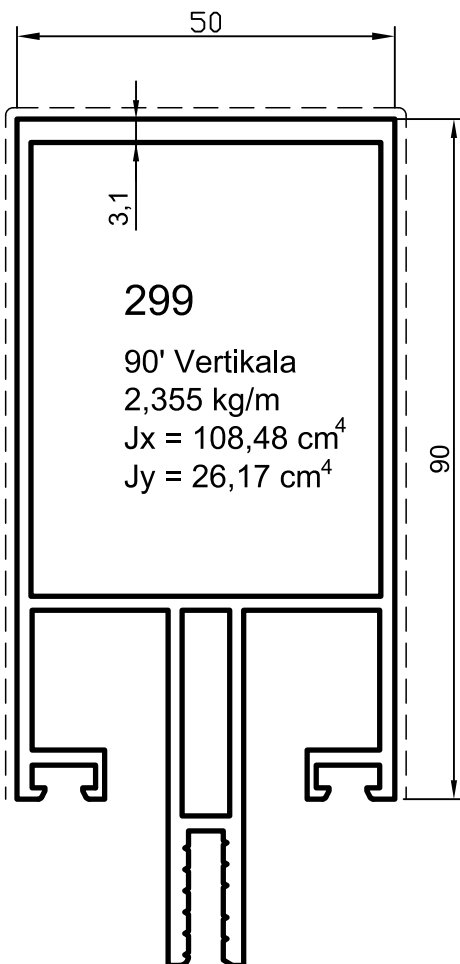
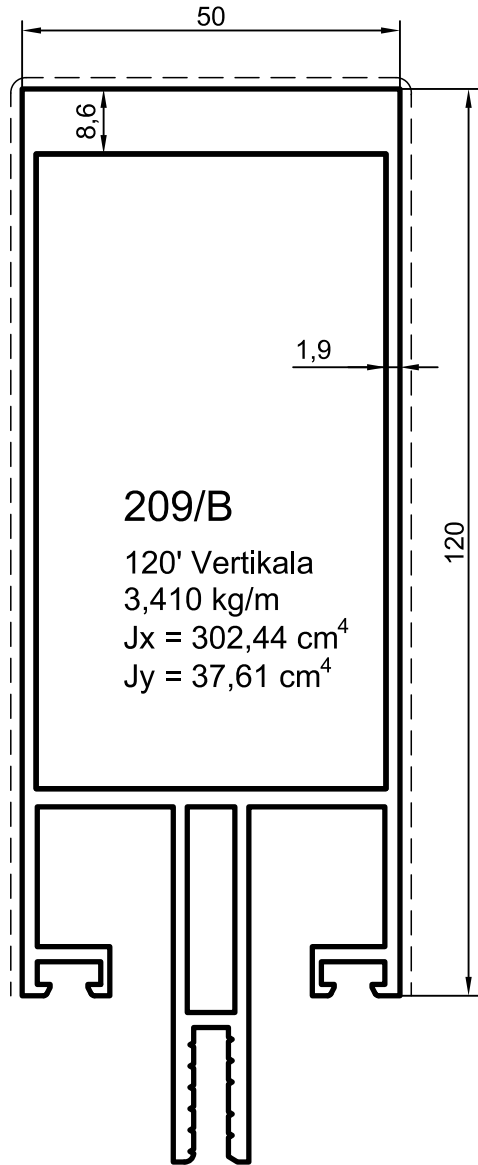
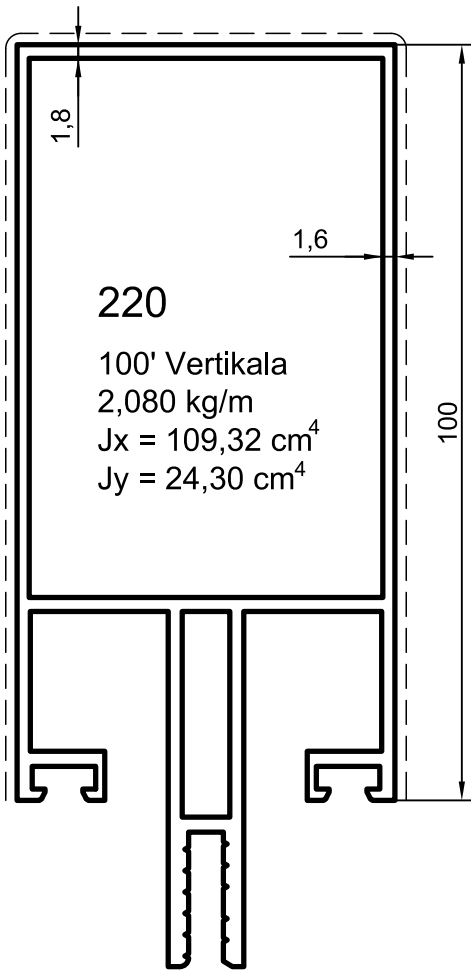

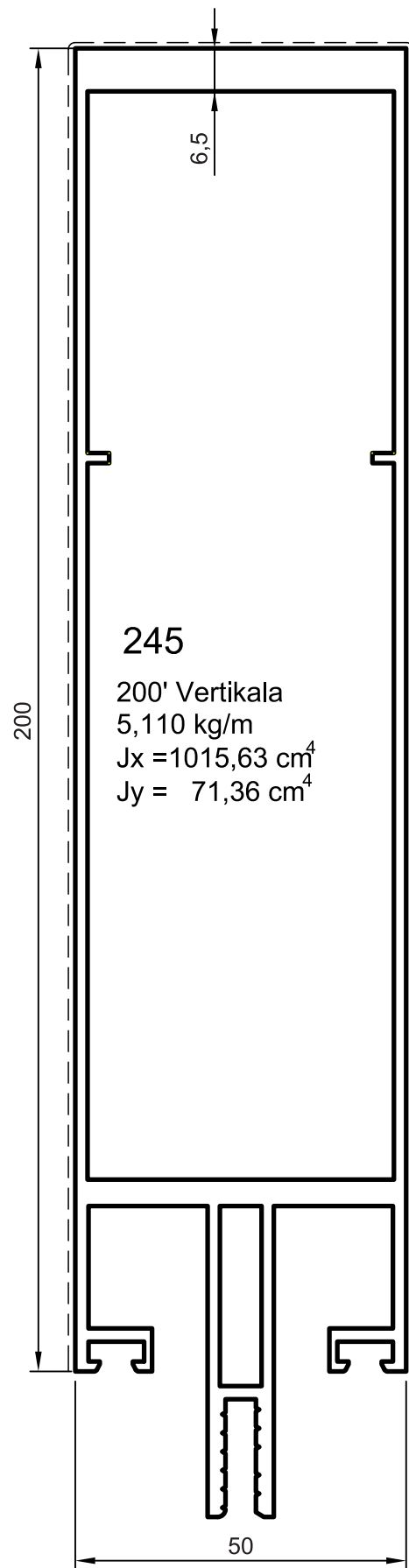
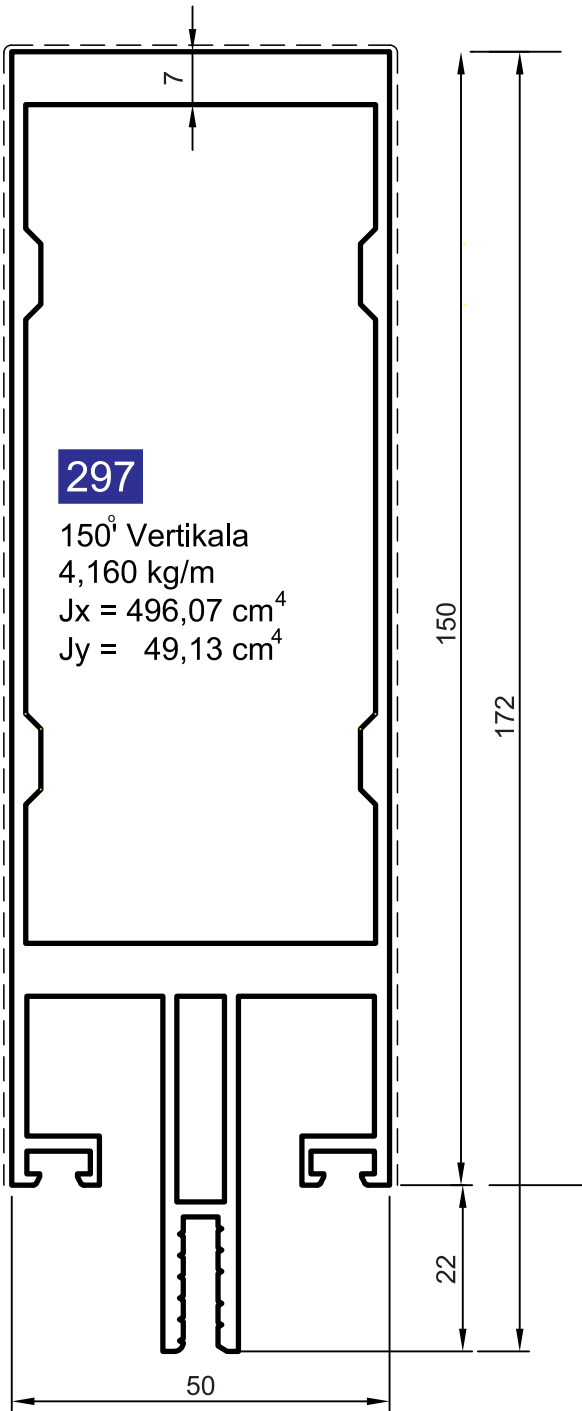

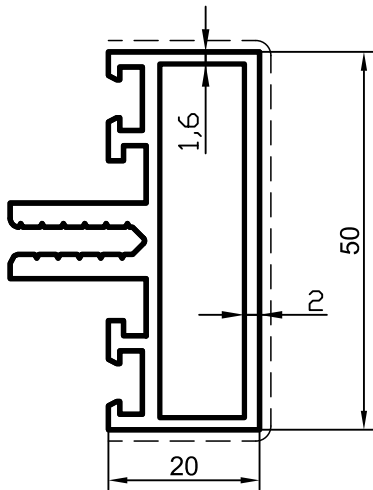

**200**

20' Horizontala za krov  
 1,040 kg/m  
 $J_x = 3,98 \text{ cm}^4$   
 $J_y = 10,52 \text{ cm}^4$

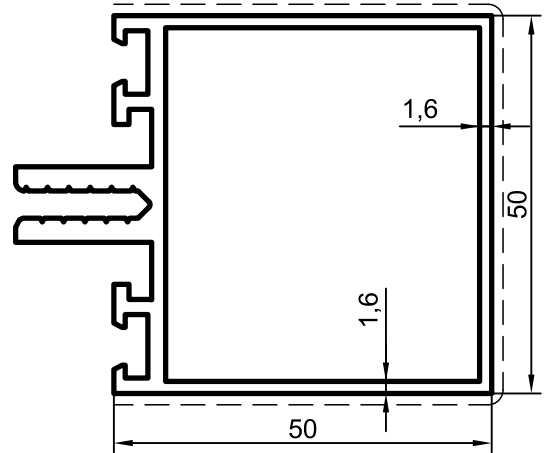

**201**

50' Horizontala  
 1,250 kg/m  
 $J_x = 13,03 \text{ cm}^4$   
 $J_y = 18,88 \text{ cm}^4$

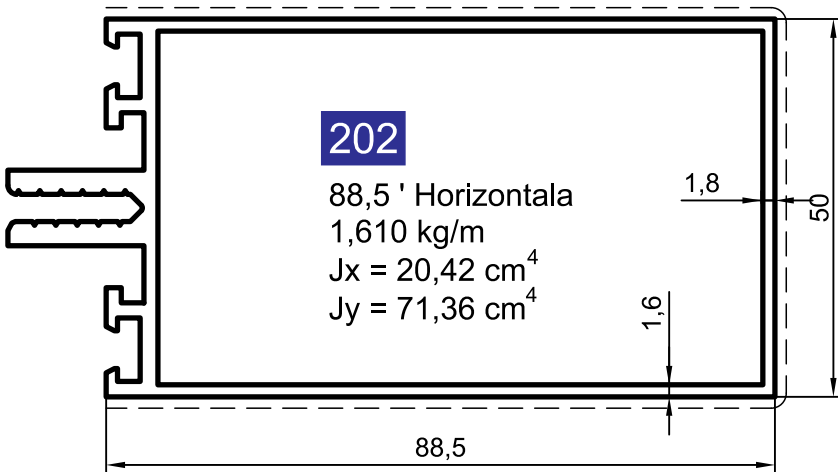

**202**

88,5' Horizontala  
 1,610 kg/m  
 $J_x = 20,42 \text{ cm}^4$   
 $J_y = 71,36 \text{ cm}^4$

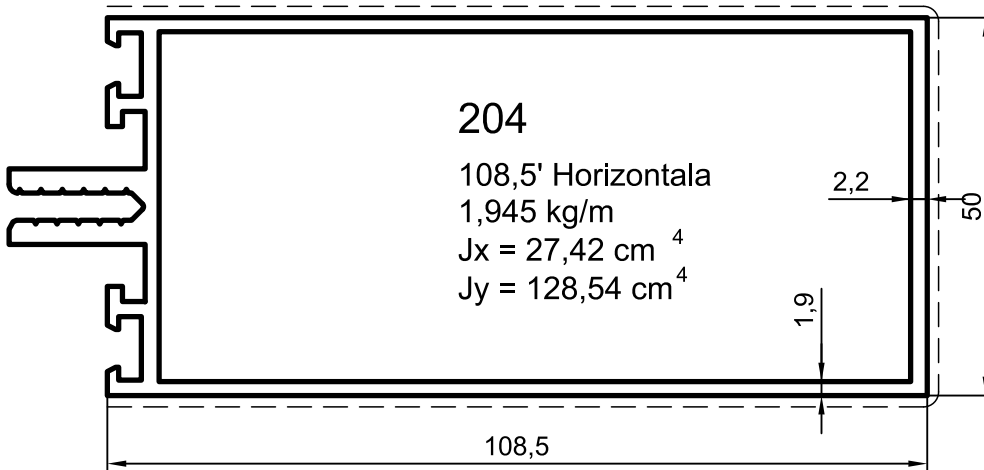

**204**

108,5' Horizontala  
 1,945 kg/m  
 $J_x = 27,42 \text{ cm}^4$   
 $J_y = 128,54 \text{ cm}^4$

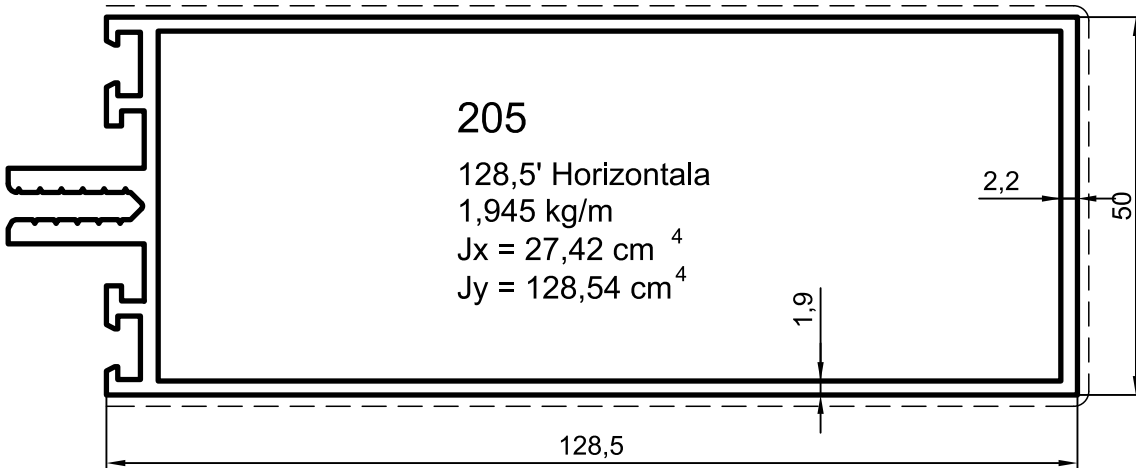

**205**

128,5' Horizontala  
 1,945 kg/m  
 $J_x = 27,42 \text{ cm}^4$   
 $J_y = 128,54 \text{ cm}^4$

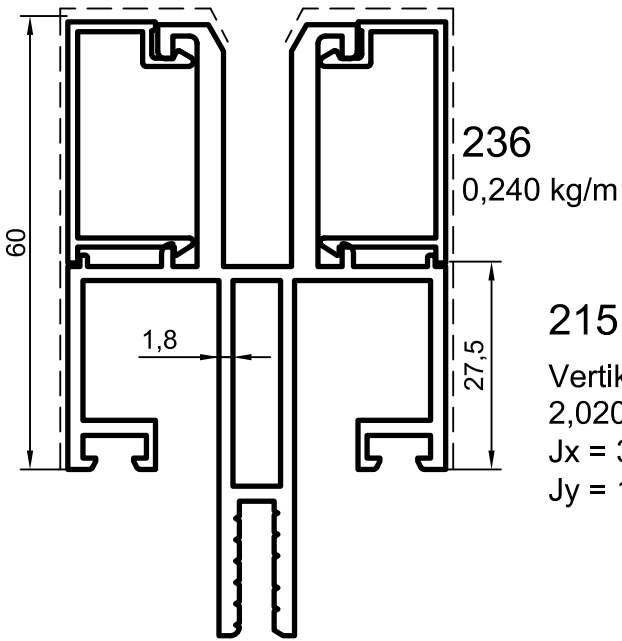

**215**  
Vertikalna specijalna  
2,020 kg/m  
 $J_x = 35,23 \text{ cm}^4$   
 $J_y = 15,40 \text{ cm}^4$

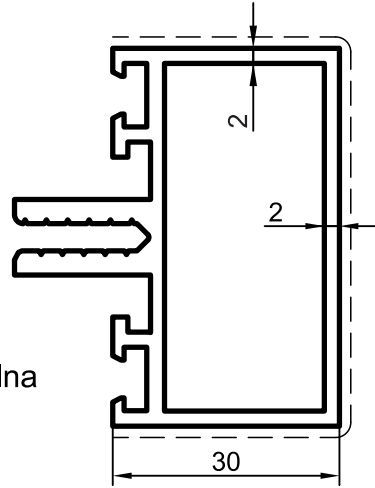

**30' Horizontala**  
1,210 kg/m  
 $J_x = 10,54 \text{ cm}^4$   
 $J_y = 7,20 \text{ cm}^4$

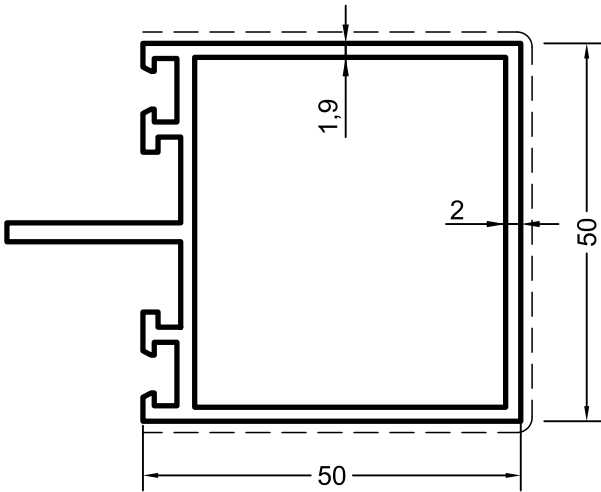

**211**  
Horizontala za silikonske fuge  
1,220 kg/m  
 $J_x = 14,46 \text{ cm}^4$   
 $J_y = 19,15 \text{ cm}^4$

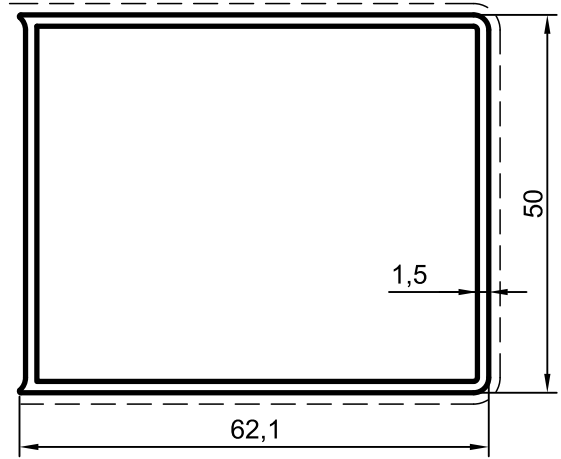

**270**  
Dopuna horizontale  
0,885 kg/m  
 $J_x = 13,39 \text{ cm}^4$   
 $J_y = 18,34 \text{ cm}^4$

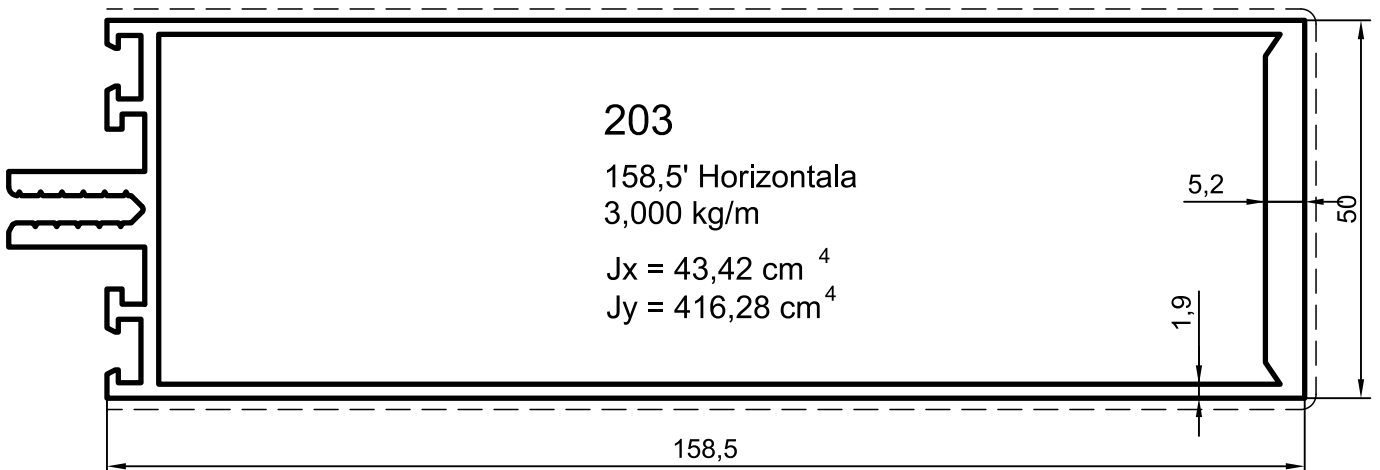

**158,5' Horizontala**  
3,000 kg/m  
 $J_x = 43,42 \text{ cm}^4$   
 $J_y = 416,28 \text{ cm}^4$

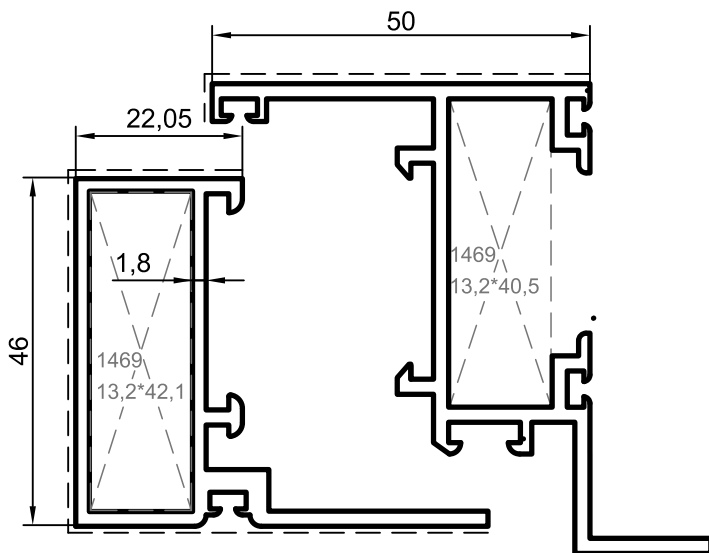

**4161-A**

Štok  
0,920 kg/m

**4196**

Krilo  
1,060 kg/m

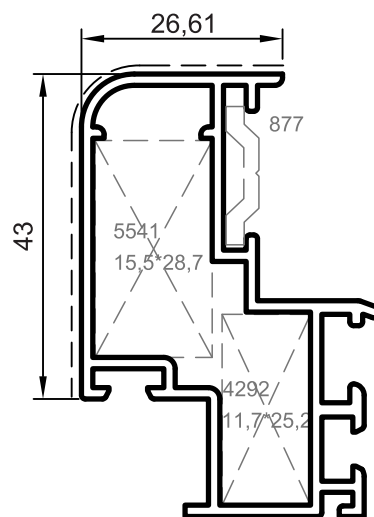

**275**

Krilo  
0,940 kg/m



**284** ( Crni eloksirani )

Lajsna za silikon  
0,110 kg/m

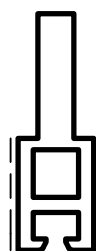

**276**

Adapter za makaze  
( 275, 796/97 )  
0,380 kg/m

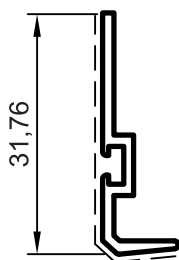

**278** ( Crni eloksirani )

Osigurač stakla  
0,185 kg/m



**877**

Pogonska letva  
0,130 kg/m

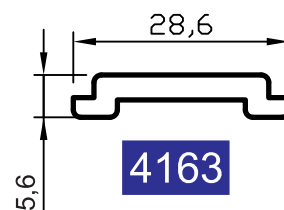

**4163**

Pogonska letva  
0,290 kg/m

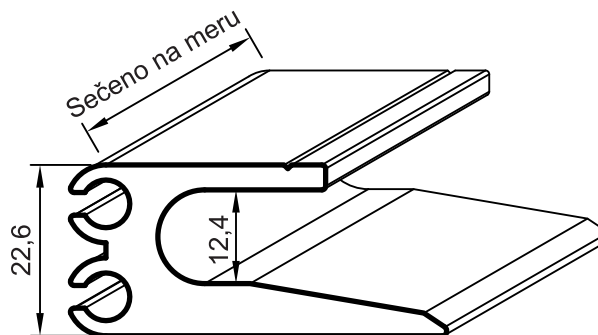

**4231**

Prihvatnik tuljka  
1,250 kg/m

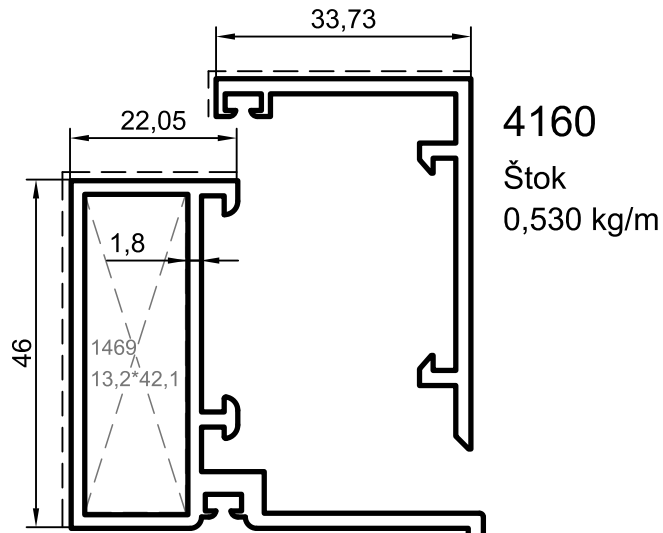

**4160**  
Štok  
0,530 kg/m

**4161**  
Kriilo  
1,430 kg/m

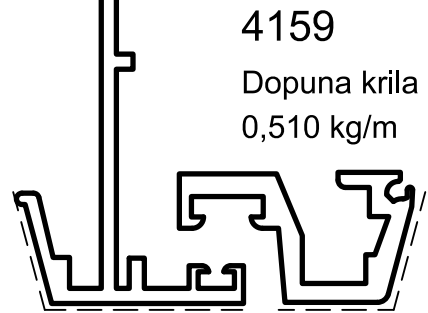

**4159**  
Dopuna kriila  
0,510 kg/m

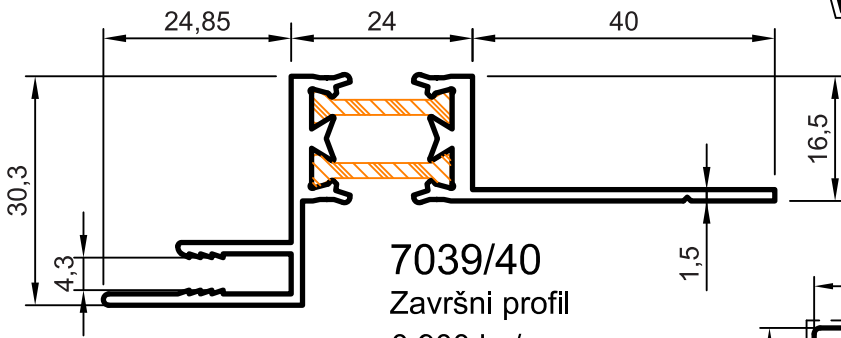

**7039/40**  
Završni profil  
0,900 kg/m

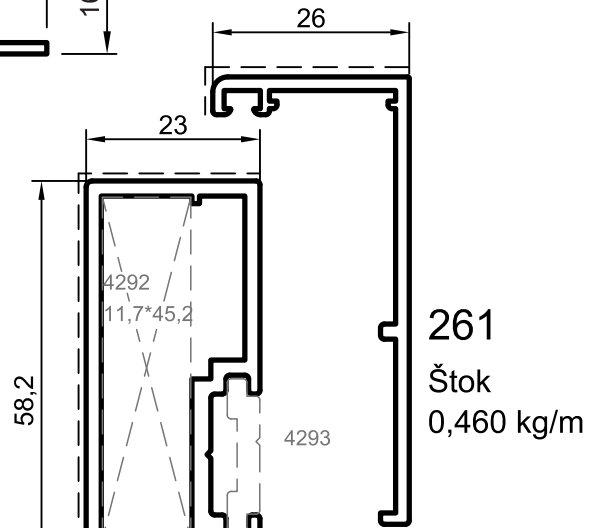

**261**  
Štok  
0,460 kg/m

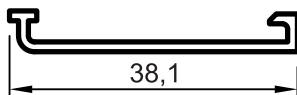

**296 ( Crni eloksirani )**

Lajsna za silikon  
0,175 kg/m

**260/4295**  
Kriilo  
1,980 kg/m

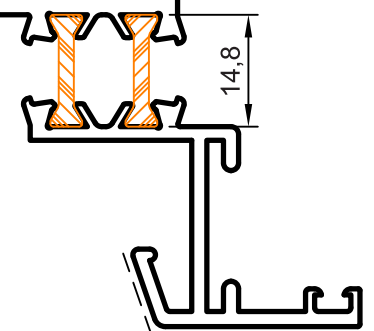



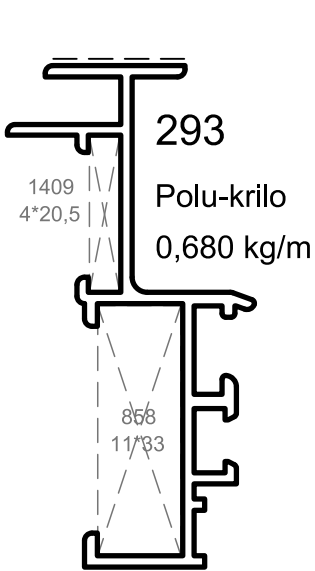

**293**  
 Polu-krilo  
 0,680 kg/m

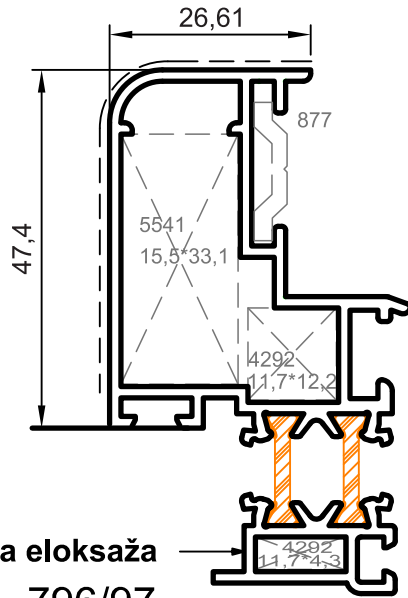

**Siva eloksaža**  
**796/97**  
 Krilo  
 1,270 kg/m  
 Napomena: 14.8 mm eurožljeb.

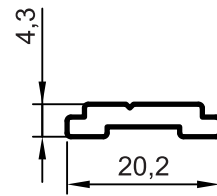

**4293**  
 Pogonska letva  
 0,180 kg/m

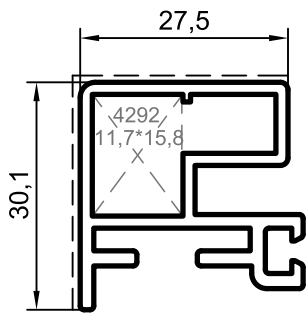

**254**  
 Eko krilo  
 0,630 kg/m

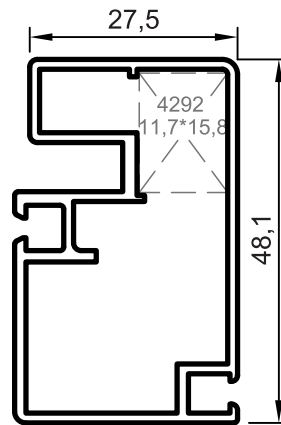

**292**  
 Eko krilo  
 0,730 kg/m

**4294**  
 Eko lajsna za silikon  
 0,210 kg/m  
 ( Siva mat eloksaža )

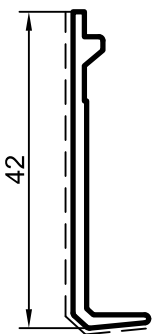

**257**  
 Eko osigurači stakla  
 0,245 kg/m  
 ( Siva mat eloksaža )

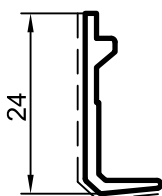

**256**  
 0,160 kg/m

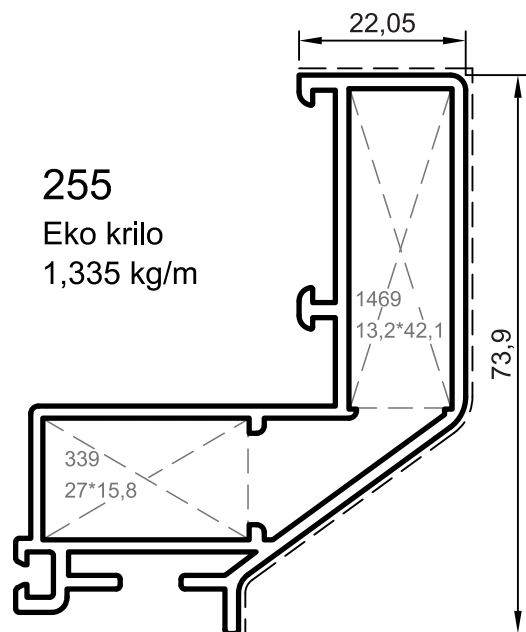

**255**  
 Eko krilo  
 1,335 kg/m

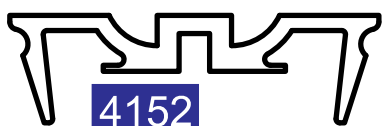

**4152**

Držač stakla  
0,440 kg/m

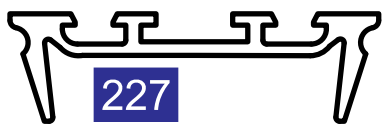

**227**

Držač stakla  
0,400 kg/m



**230**

Krovni poklopac  
0,780kg/m

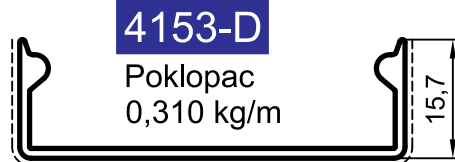

**4153-D**

Poklopac  
0,310 kg/m



**265**

Poklopac  
0,385 kg/m



**264**

Poklopac  
0,310 kg/m

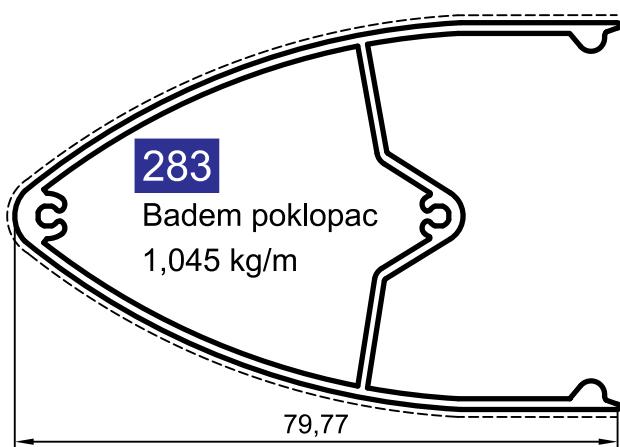

**283**

Badem poklopac  
1,045 kg/m

**287**

( Dužina 100 mm )  
Naslom krila  
0,280 kg/m

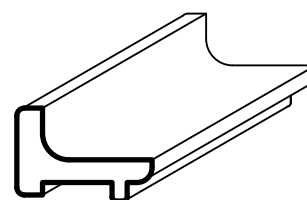
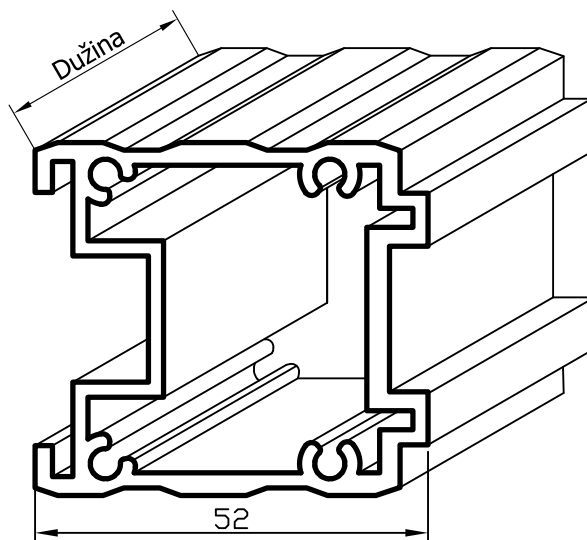
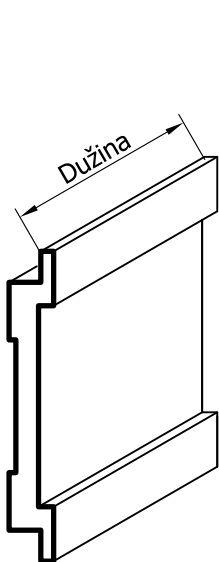
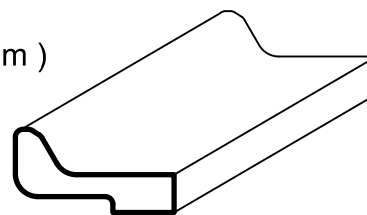

**280**

(Dužina 50mm)  
Držač krila  
0,240 kg/m

**239**

Nosač spojnice  
0,360 kg/m

**238**

Spojnica  
1,580 kg/m

238 i 239 spojnice za profile

Profil	Dužina
201, 211	40,8 mm
202	79,1 mm
204	99,1 mm
205	119,1 mm

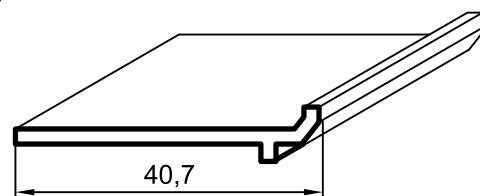
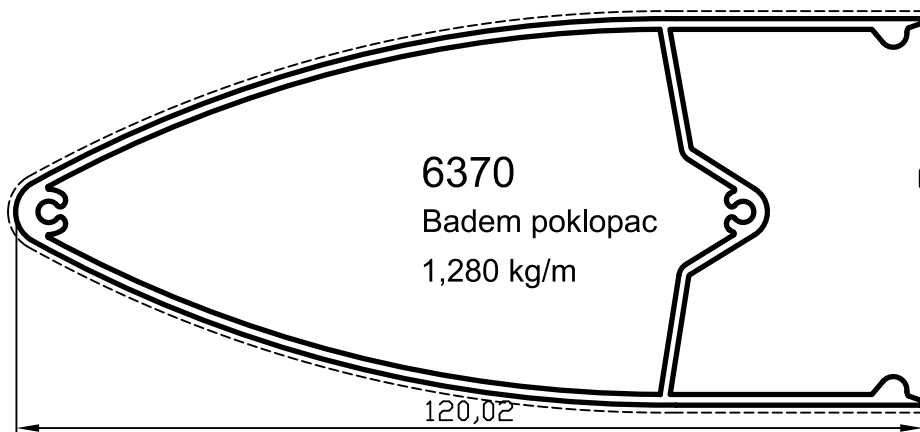
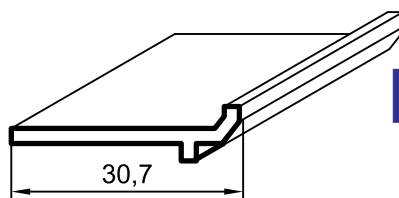
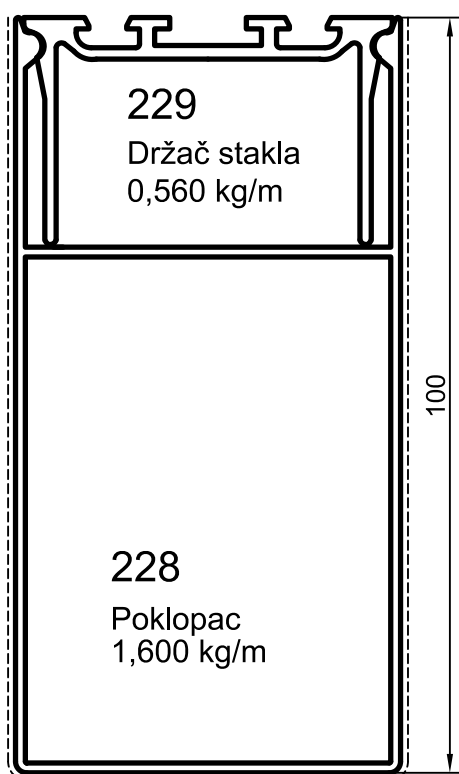
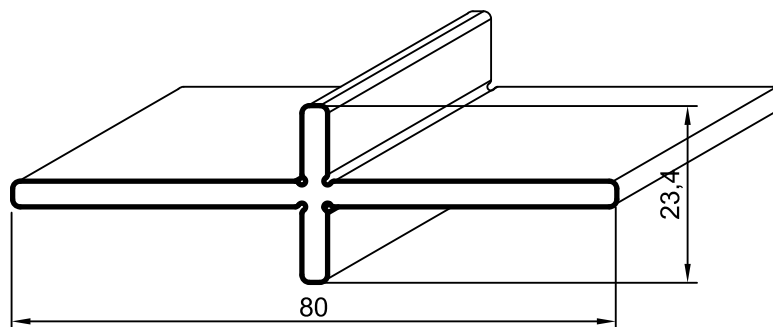
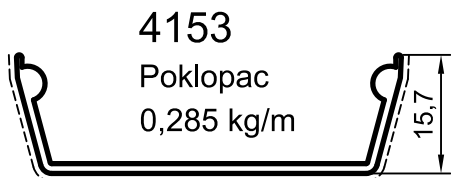
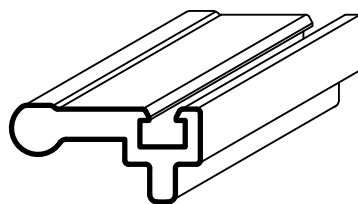
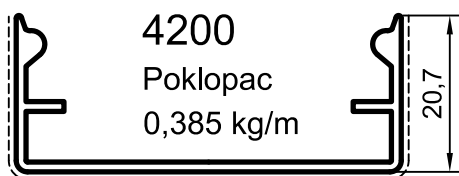

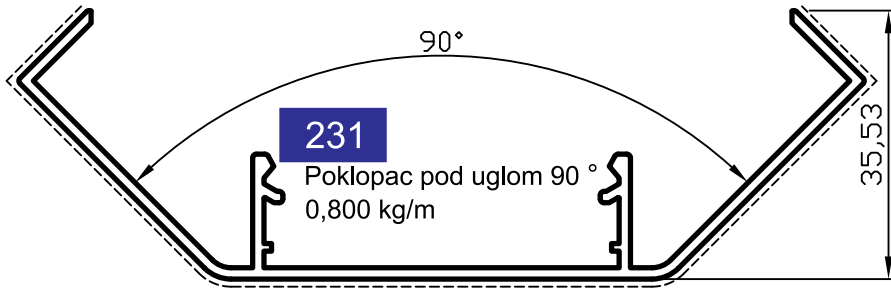
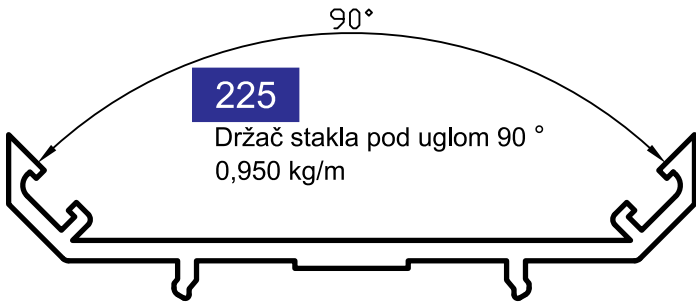

**4202**  
Držač stakla pod uglom 150 °  
0,650 kg/m

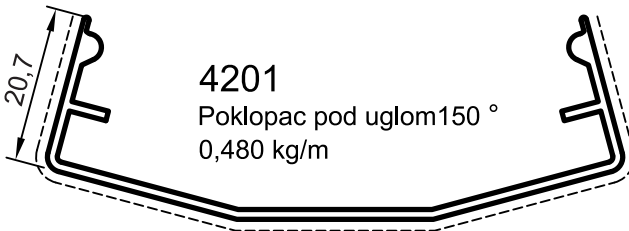
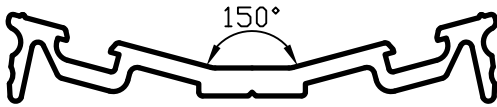

**226**  
Držač stakla  
0,620 kg/m

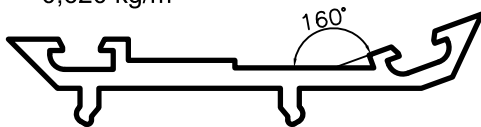

**232**  
Poklopac  
0,540 kg/m

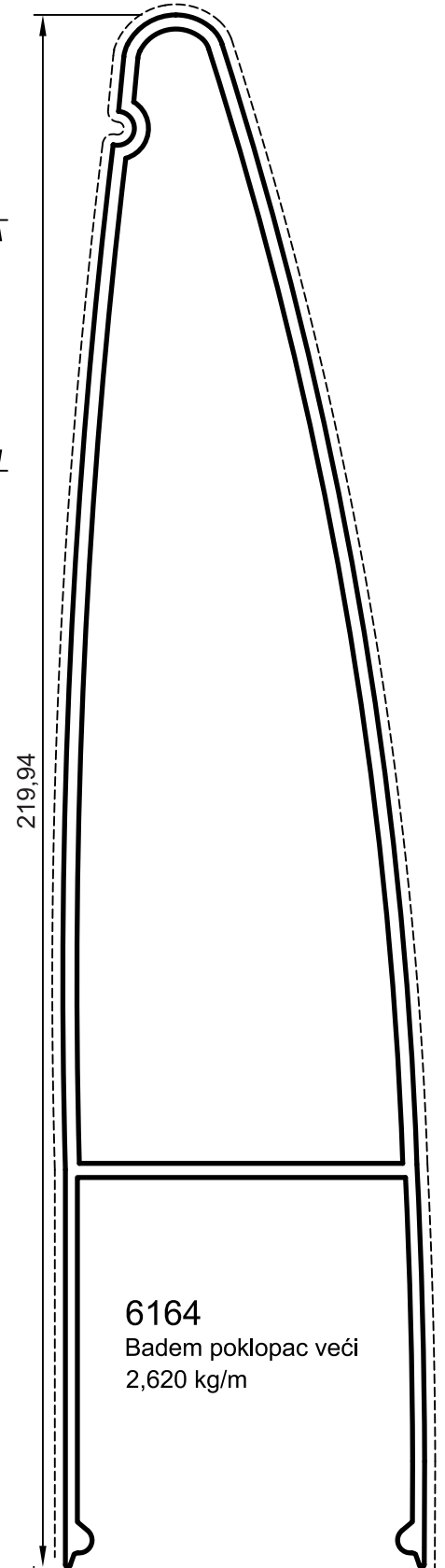
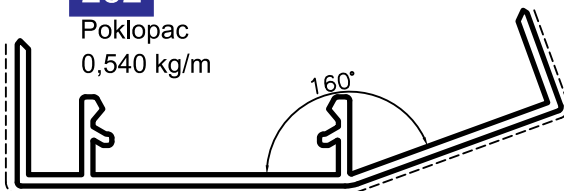

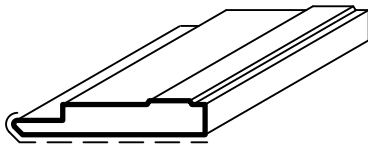

**294**  
0,240 kg/m  
Osigurač stakla  
( Rezano na 50 mm )

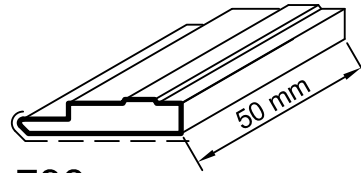

**798**  
0,200 kg/m  
Osigurač stakla  
( Rezano na 50 mm )

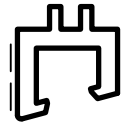
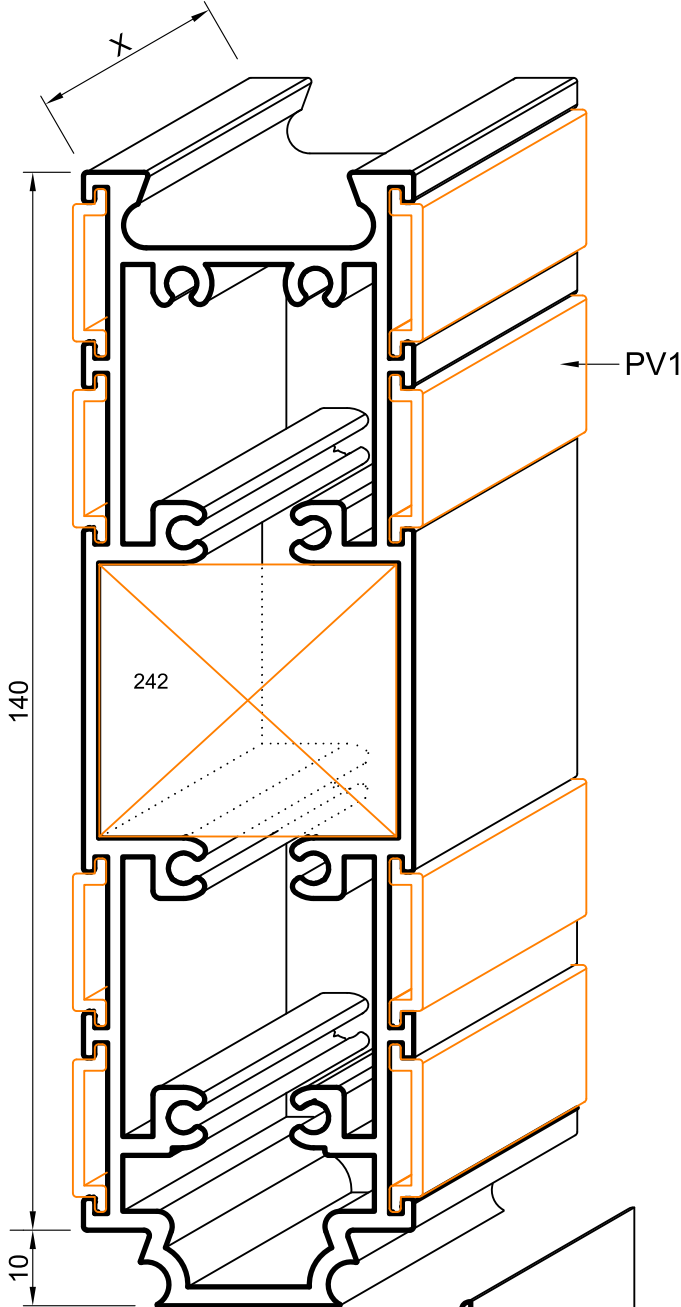

**4203**  
Nosач gume 150°  
0,230 kg/m

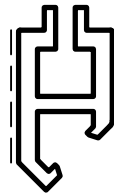

**247**  
Nosач gume pod uglom 90°  
0,325 kg/m

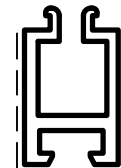

**248**  
Nosач gume ravni  
0,270 kg/m

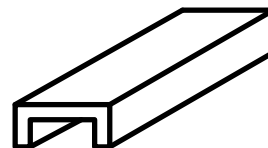

**295**  
( Rezano na 50 mm )  
0,110 kg/m

**252**

Dilataciona spojnica  
3,415 kg/m

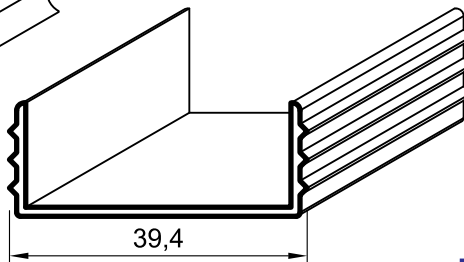



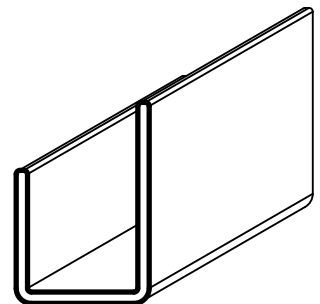









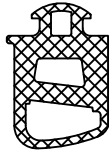
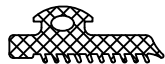

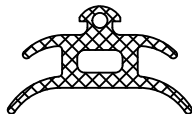
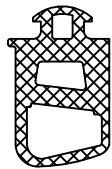
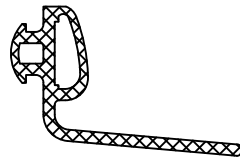

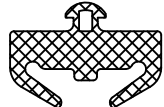
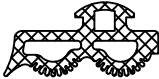



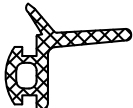

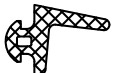
**242**  
( Rezano na 36 mm )  
Dilatacioni poklopac  
0,230 kg/m

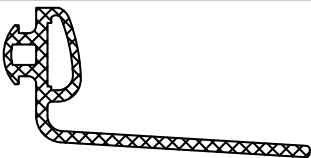
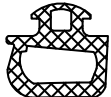
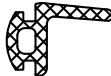

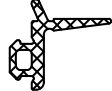

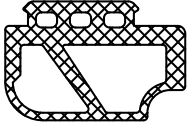
**241**

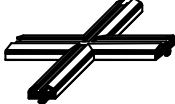
( Rezano na 200 mm )  
Dilatacioni nastavak drenaže  
0,205 kg/m

• Gumeni profili				
Slika	Šifra	Materijal	Naziv	Paket
	EPİL 1-3	EPDM	Guma stakla	290 m/pk
	EPİL 7	EPDM	Diht guma	800 m/pk
	EPİL 5-2	EPDM	Guma stakla " 2 mm "	400 m/pk
	Epil 27	EPDM	Diht guma	420 m/pk
	EPİL 31	EPDM	Guma horizontale " 3.5 mm "	250 m/pk
	EPİL 33	EPDM	Guma vertikalne " 12.5 mm "	100 m/pk
	EPİL 34	EPDM	Guma poklopnog profila 225, 226, 227, 229, 4202 "	150 m/pk
	EPİL 37	EPDM	Guma poklopnog profila 4152	80 m/pk
	EPİL 39	Silikon	Guma za silikonsku fugu	100 m/pk
	EPİL 40	EPDM	Guma vertikalne " 14.5 mm "	80 m/pk
	EPİL 42	EPDM	Guma horizontale sa drenažom " 3.5 mm "	130 m/pk
	EPİL 46	EPDM	Guma osigurača	350 m/pk
	EPİL 47	EPDM	Centralna guma	105 m/pk
	EPİL 48	EPDM	Guma poklopnog profila 227	145 m/pk
	EPİL 49	EPDM	Guma horizontale" 5.5 mm "	200 m/pk
	EPİL 51	Silikon	Pokrivna guma za fugu (silikon)	100 m/pk

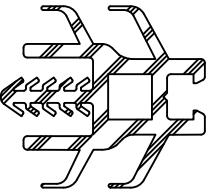
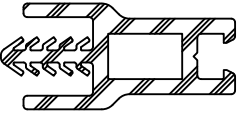
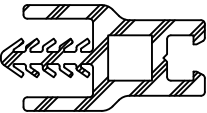
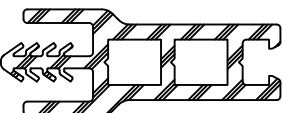
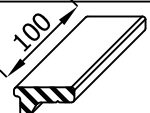
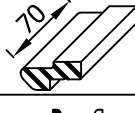
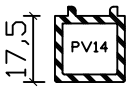
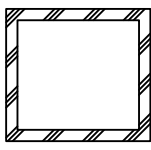
• Gumeni profili				
Slika	Šifra	Materijal	Naziv	Paket
	EPIL52	EPDM	Guma osigurača	240 m/pk
	EPIL53	Silikon	Guma za silikonsku fugu	100 m/pk
	EPIL 54	EPDM	Eko guma za osigurač	320 m/pk
	EPIL 65	Silikon	Pokrivna guma	100 m/pk
	EPIL 66	EPDM	Guma za pokrivni profil 4152	80 m/pk
	EPIL 67	EPDM	Guma za horizontalu sa drenažom 34mm	100 m/pk
	EPIL 68	EPDM	Guma za horizontalu " 9 mm "	85 m/pk
	EPIL 77	EPDM	Guma osigurača	100 m/pk
	EPIL 85-1	EPDM	Guma stakla (4 mm)	200 m/pk
	EPIL 86	EPDM	Guma osigurača	290 m/pk
	EPIL 196	EPDM	Guma profila 8054	250 m/pk
	EPIL 217	EPDM	Guma profila 8048	75 m/pk
	EPIL241	EPDM	Guma " 6 mm "	250 m/pk
	K01	EPDM	Krst gume EPIL 47	50 kom/pk
	Epil 233	EPDM	Guma diht	415 m/pk
	Epil 236	EPDM	Spoljna guma	260 m/pk

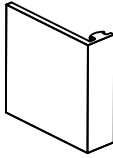
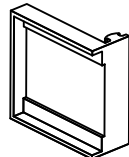
• Prateći materijal				
Slika	Šifra	Materijal	Naziv	Paket
	PV1	PVC	Dilatazione plastike	3 m/kom
	PV2	PVC	Plastični distancer (15 MM)	150 m/pk (50 kom. 3m)
	PV3	PVC	Plastični distancer (19 MM)	150 m/pk (50 kom. 3m)
	PV4	PVC	Plastični distancer (15 MM)	150 m/pk (50 kom. 3m)
	PV5	PVC	Plastični distancer (25 MM)	120 m/pk (40 kom. 3m)
	PV6	PVC	Plastični naslon	50 kom/pk
	PV7	PVC	Plastični uvodnik	50 kom/pk
	PV14	PVC	Plastični Podmetač profila " 8047	50 kom/pk
	PV 25	PVC	Plastična kutija " 16,5x18,5 "	150 m/pk (50 kom, 3m/kom)
	PV 26		Plastična kutija " 17x25 "	90 m/pk (30 kom, 3m/kom)
	PV 27		Plastična kutija " 17x30 "	90 m/pk (30 kom, 3m/kom)
	PV 28		Plastična kutija " 17x34 "	90 m/pk (30 kom, 3m/kom)
	PV 29		Plastična kutija "20x24,5 "	90 m/pk (30 kom, 3m/kom)
	SC-435	INOX	Podloška stakla (L:100mm)	20 kom/pk
	SC-520_50	EPDM	Yaka 50	50 kom/pk
	SC-520_88.5		Yaka 88,5	
	SC-520_108.5		Yaka 108,5	
	SC-520_128.5		Yaka 128.5	
	SC-520_158.5		Yaka 158.5	
	SC-521_50	EPDM	K Yaka 50	50 kom/pk
	SC-521_88.5		K Yaka 88,5	
	SC-521_108.5		K Yaka 108,5	
	SC-521_128.5		K Yaka 128.5	
	SC-521_158.5		K Yaka 158.5	

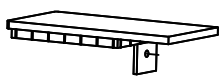
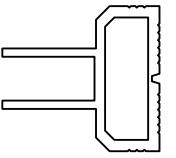
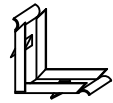
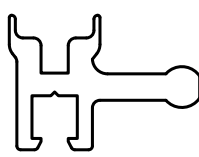
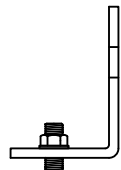
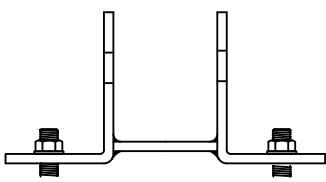
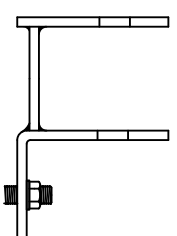

• Prateći materijal				
Slika	Šifra	Materijal	Naziv	Paket
	SC-268	Metal	Tuljak 12x12	100 kom/pk
	SC-269	PVC	PVC čep profila 228	50 kom/pk
	SC-502	Aluminijum	Lajsna za nalivanje stakala (6 mt/kom)	600 m/pk
	SC-504	Prohrom	Spojnica za SC-502	50 kom/pk
	SC-506	Aluminijum	Držač stakla za profil 289 (50 mm/kom) Postavljanje na razmaku od 300 mm	6 m profil
	SC-522_80	Metal cinkovani	80 mm L Kotva	Komad
	SC-522_100		100 mm L Kotva	
	SC-522_120		120 mm L Kotva	
	SC-522_150		150 mm L Kotva	
	SC-523_80	Metal cinkovani	80 mm U Kotva	Komad
	SC-523_100		100 mm U Kotva	
	SC-523_120		120 mm U Kotva	
	SC-523_150		150 mm U Kotva	
	SC-524_80	Metal cinkovani	80 mm F Kotva	Komad
	SC-524_100		100 mm F Kotva	
	SC-524_120		120 mm F Kotva	
	SC-524_150		150 mm F Kotva	
	SC-525	PVC	Plastični klin	50 kom/pk

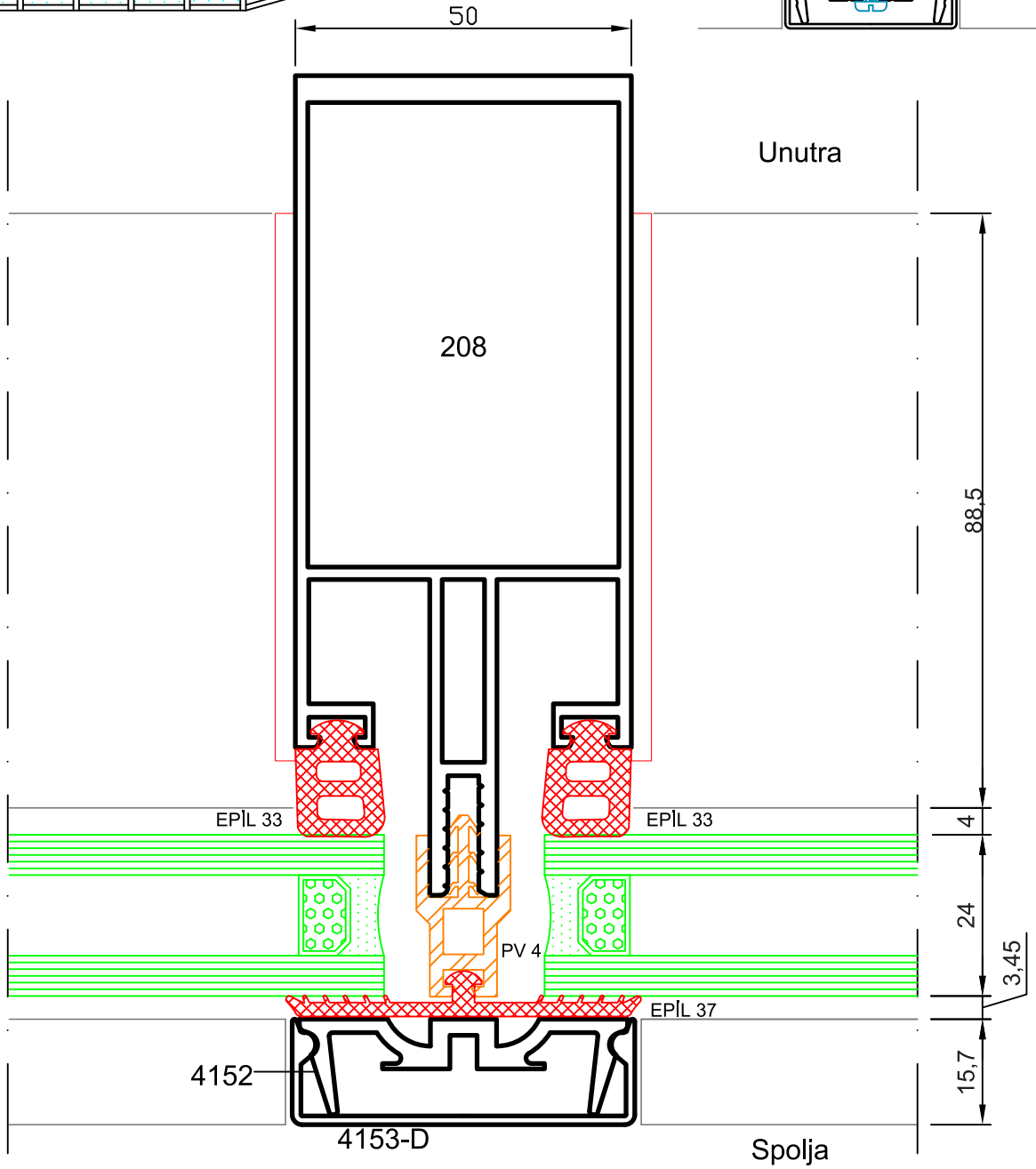
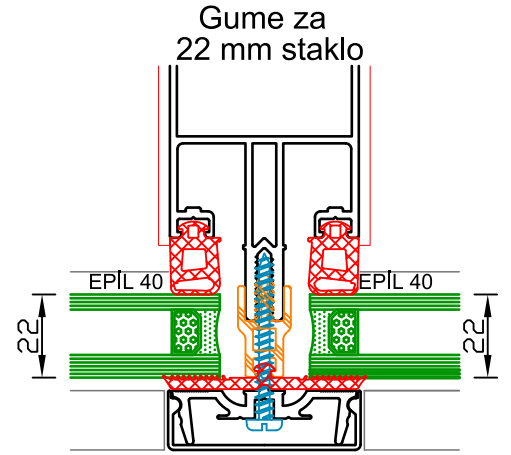
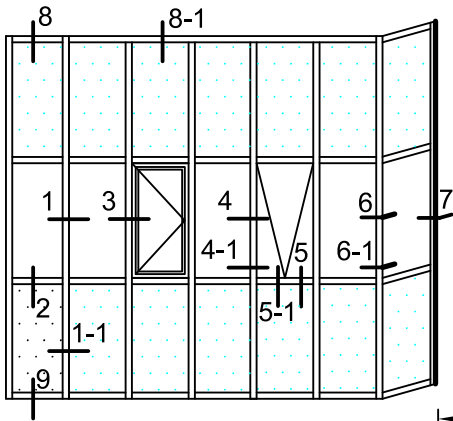

1

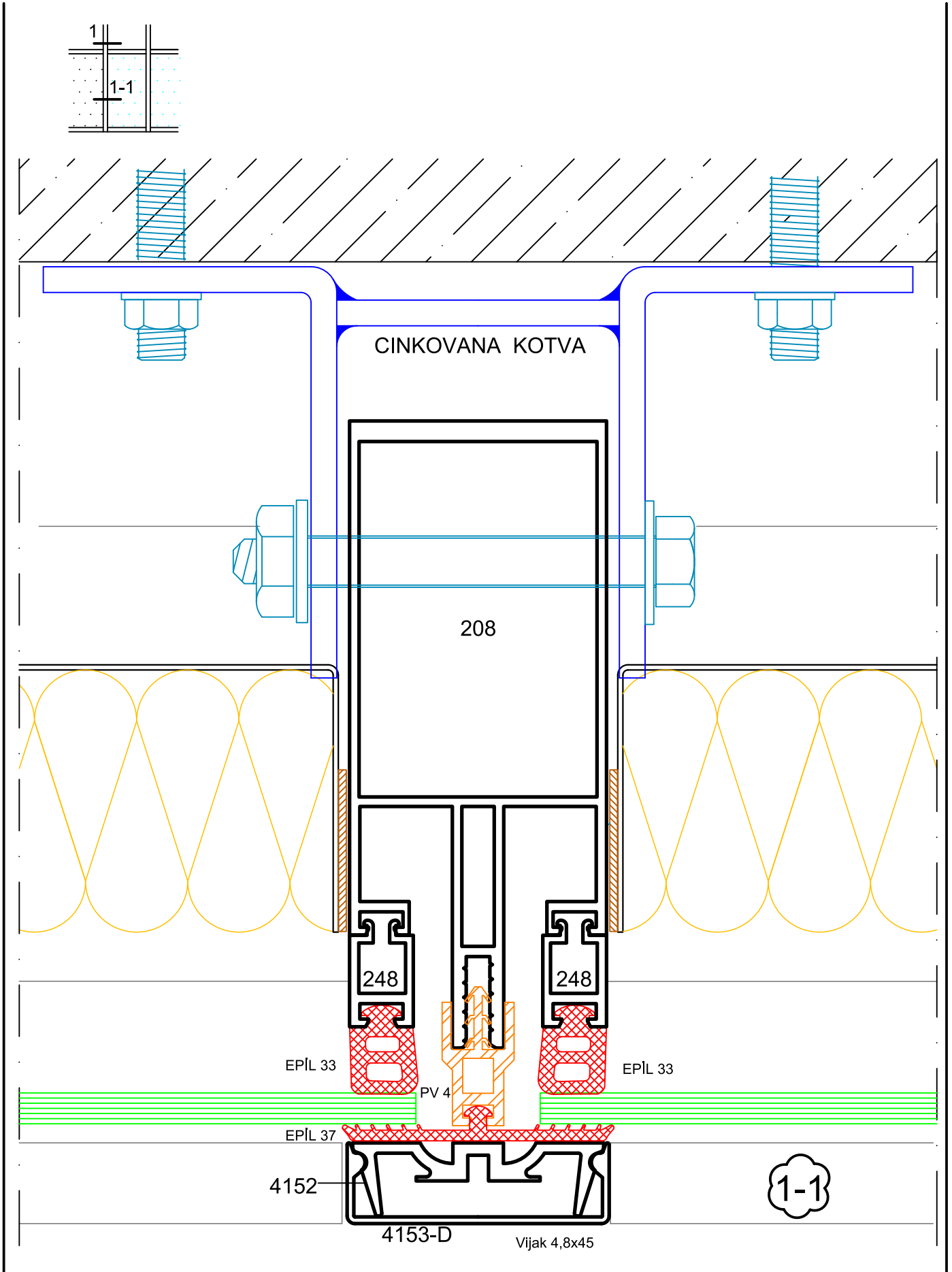

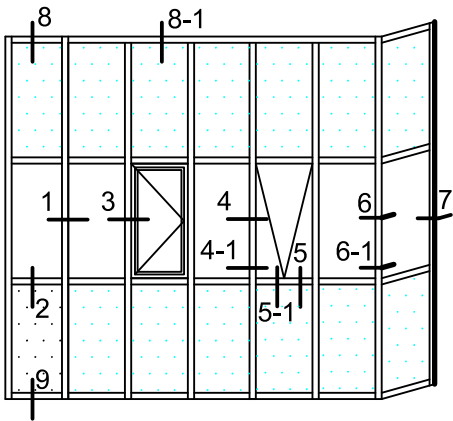

2

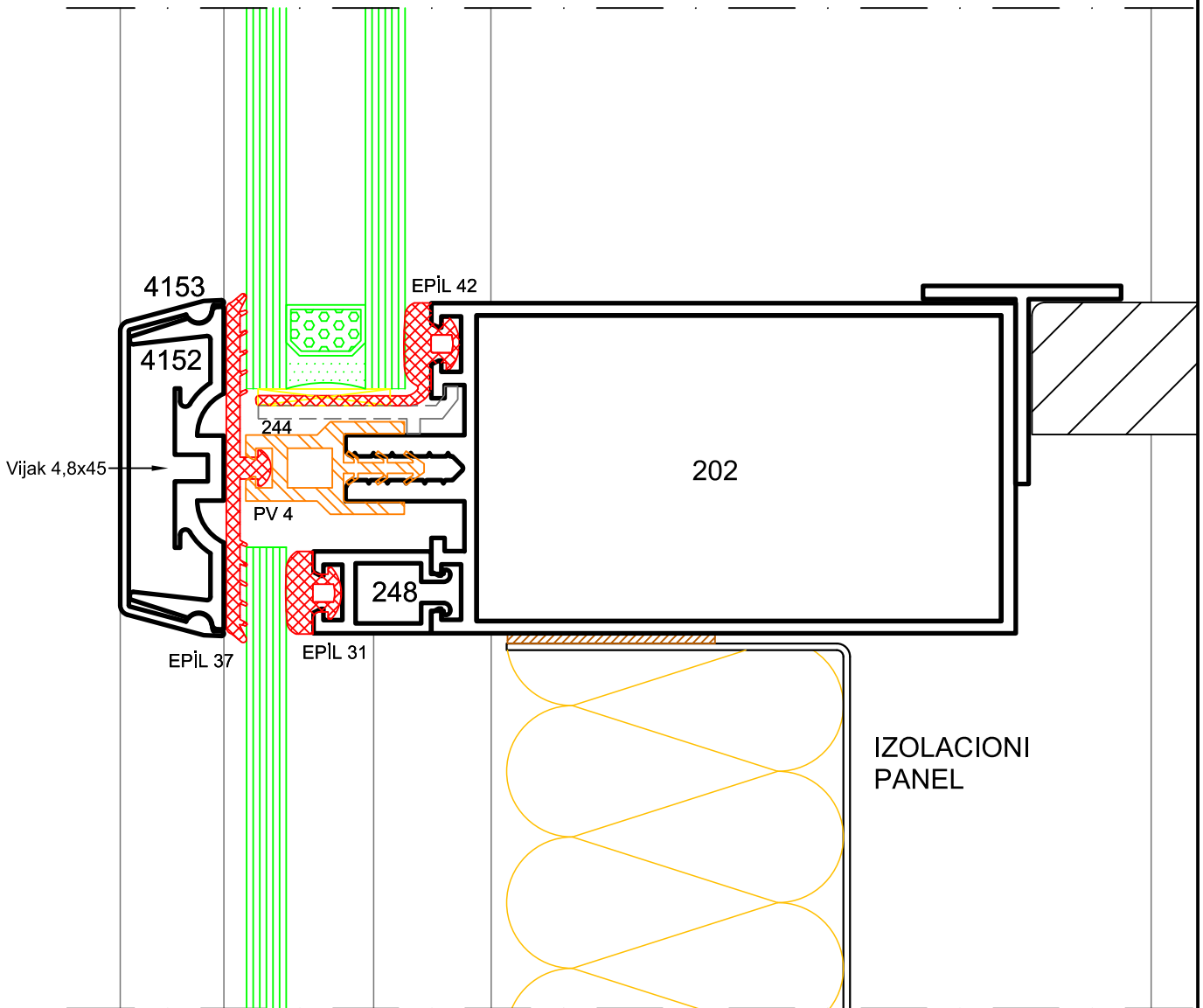
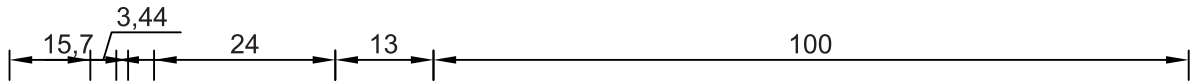
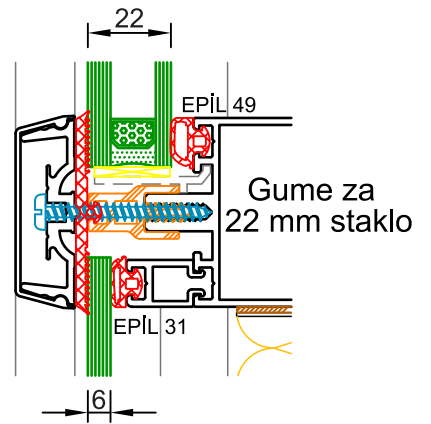

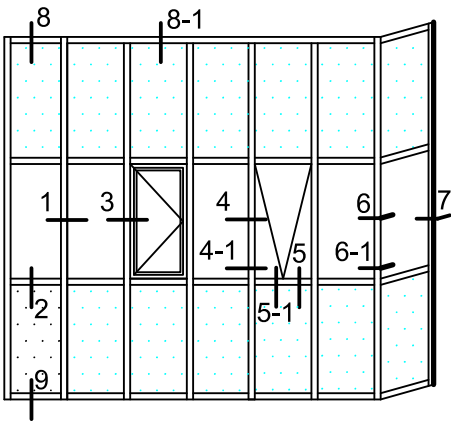

3

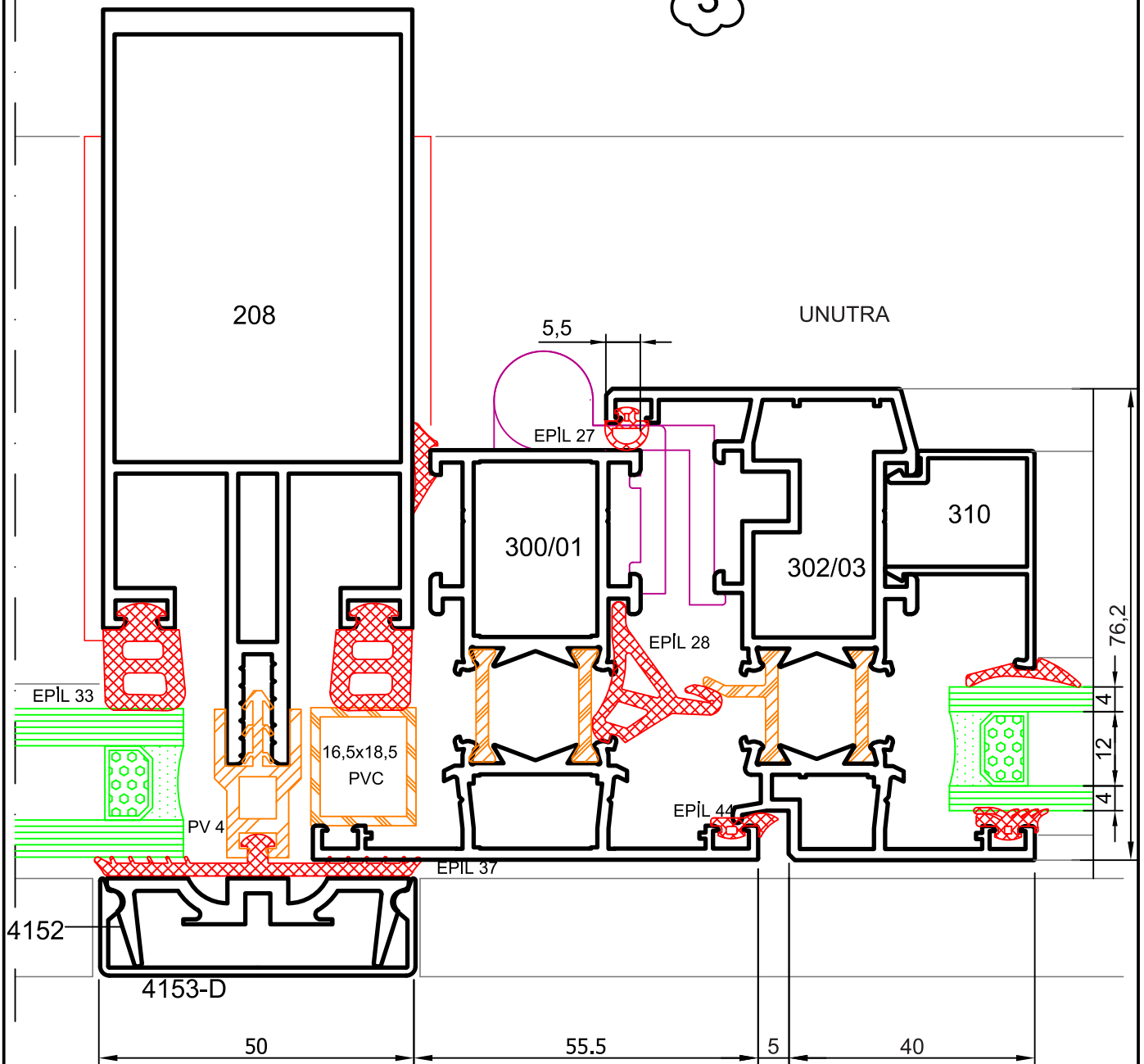

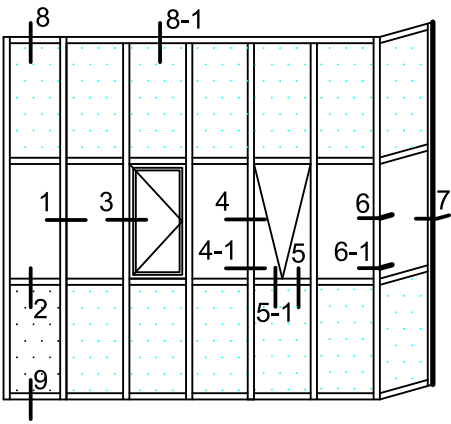

4

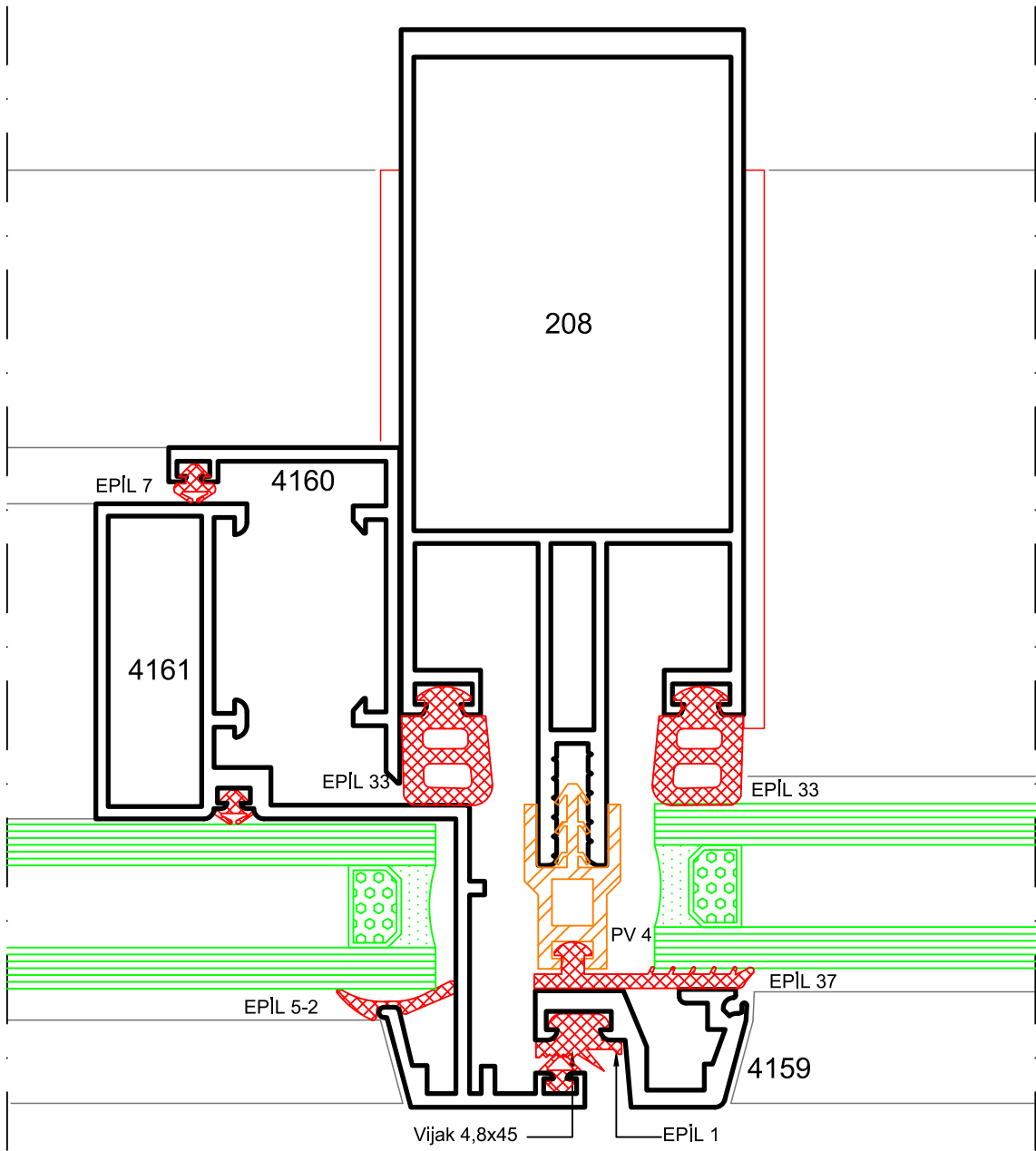

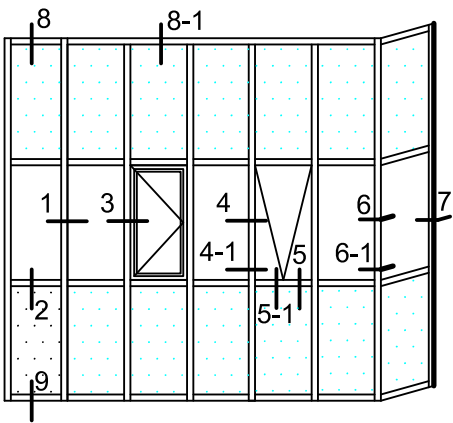

5

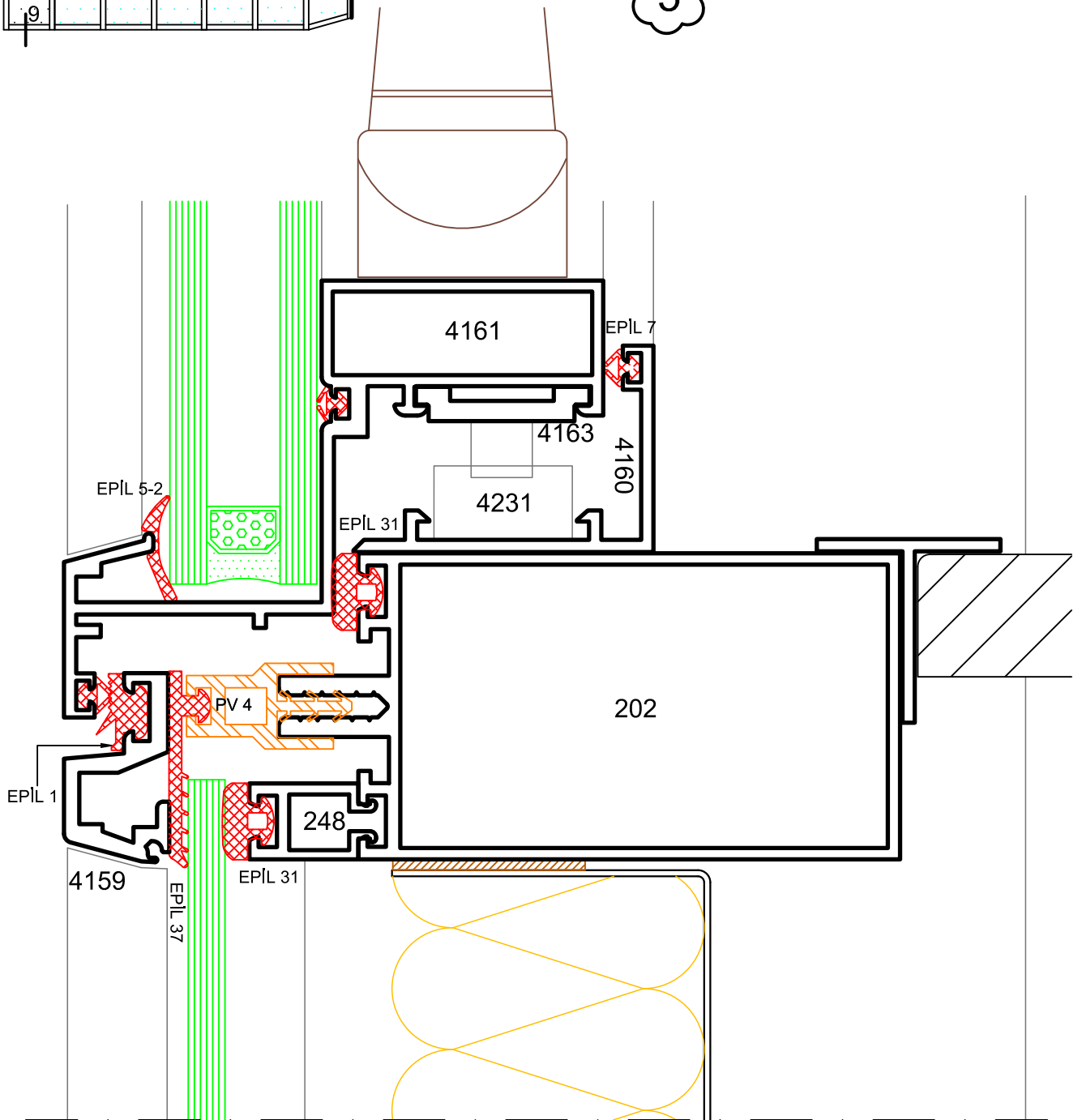

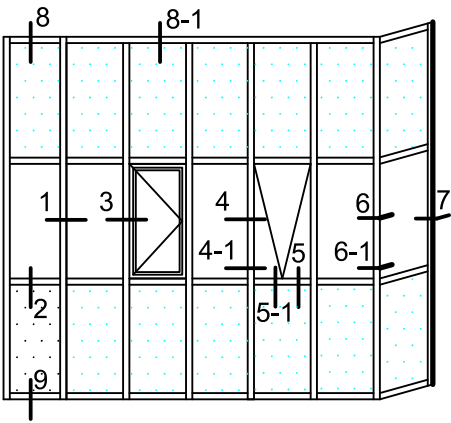

Zastakljivanje plastificiranih profila

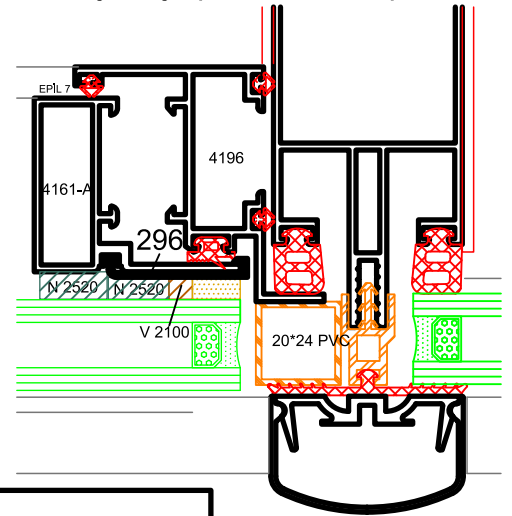

\*\* Ako je 4161-A plastificiran onda se koristi 296 elox

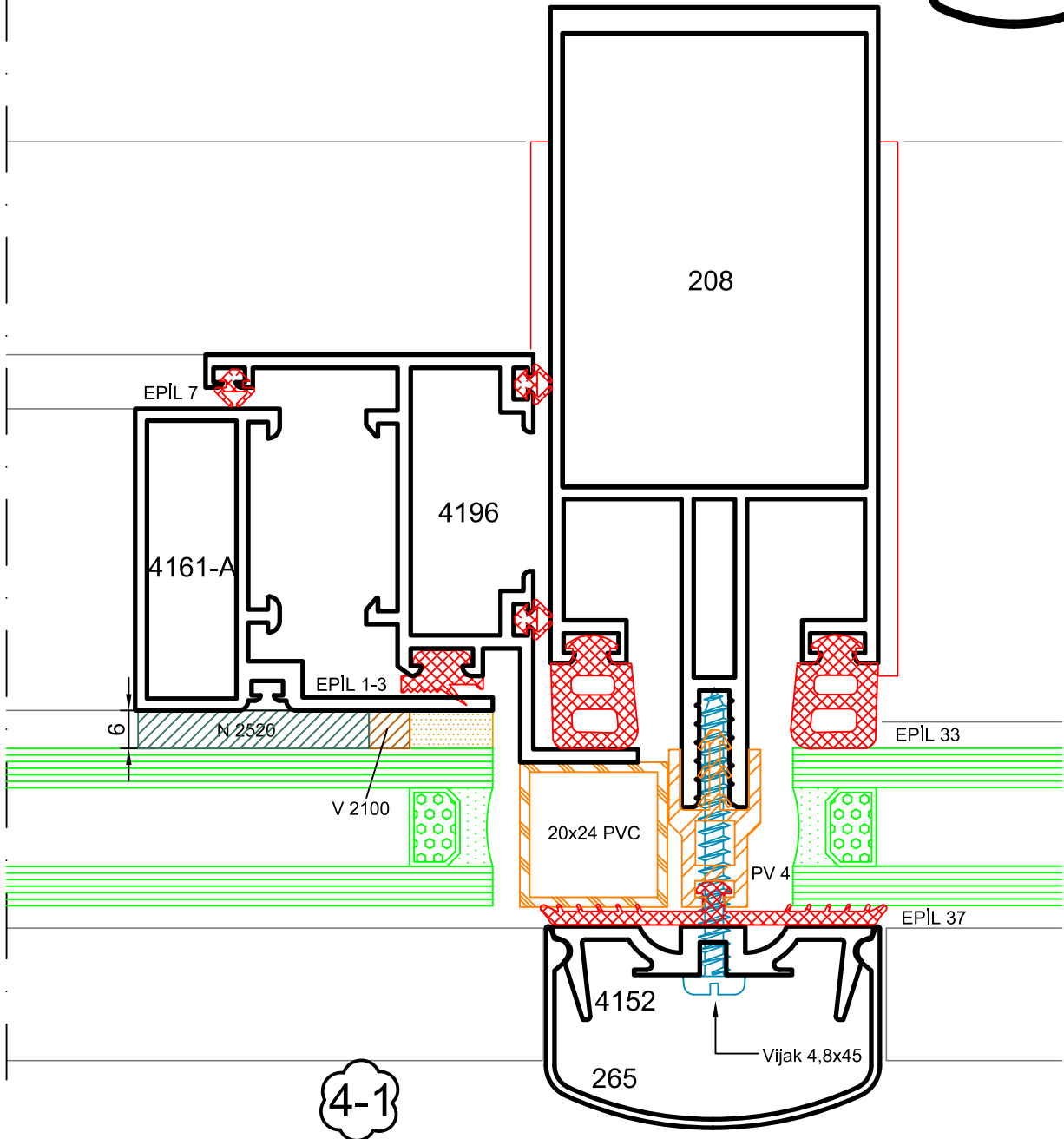

4-1



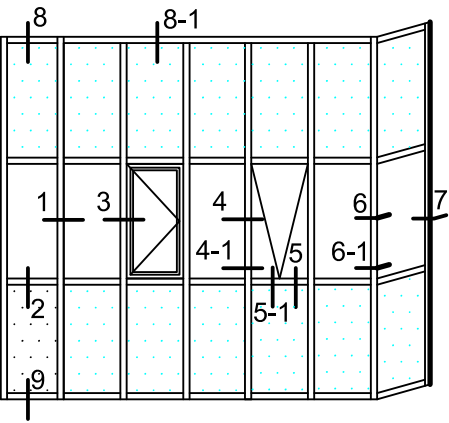

5-1

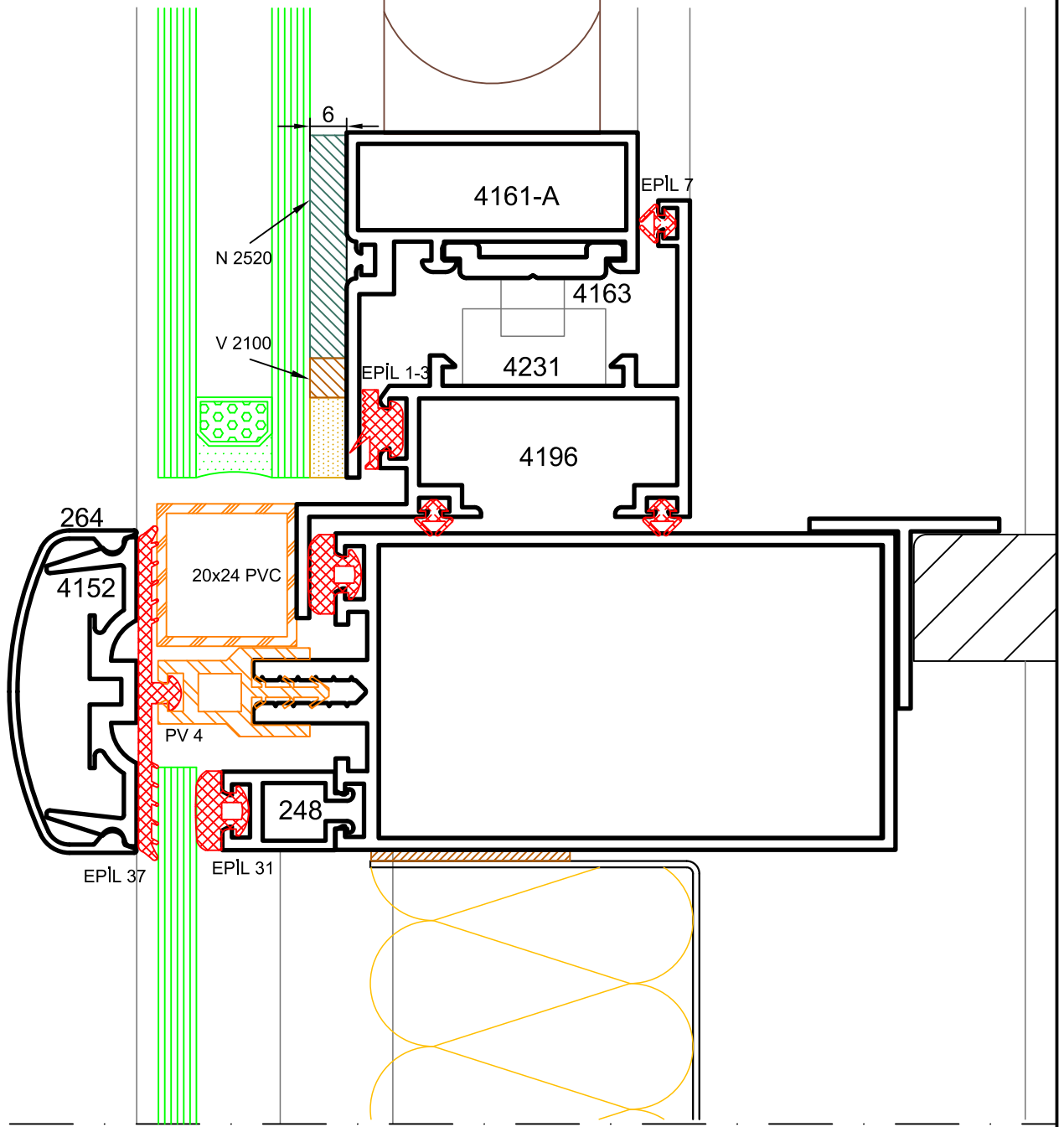

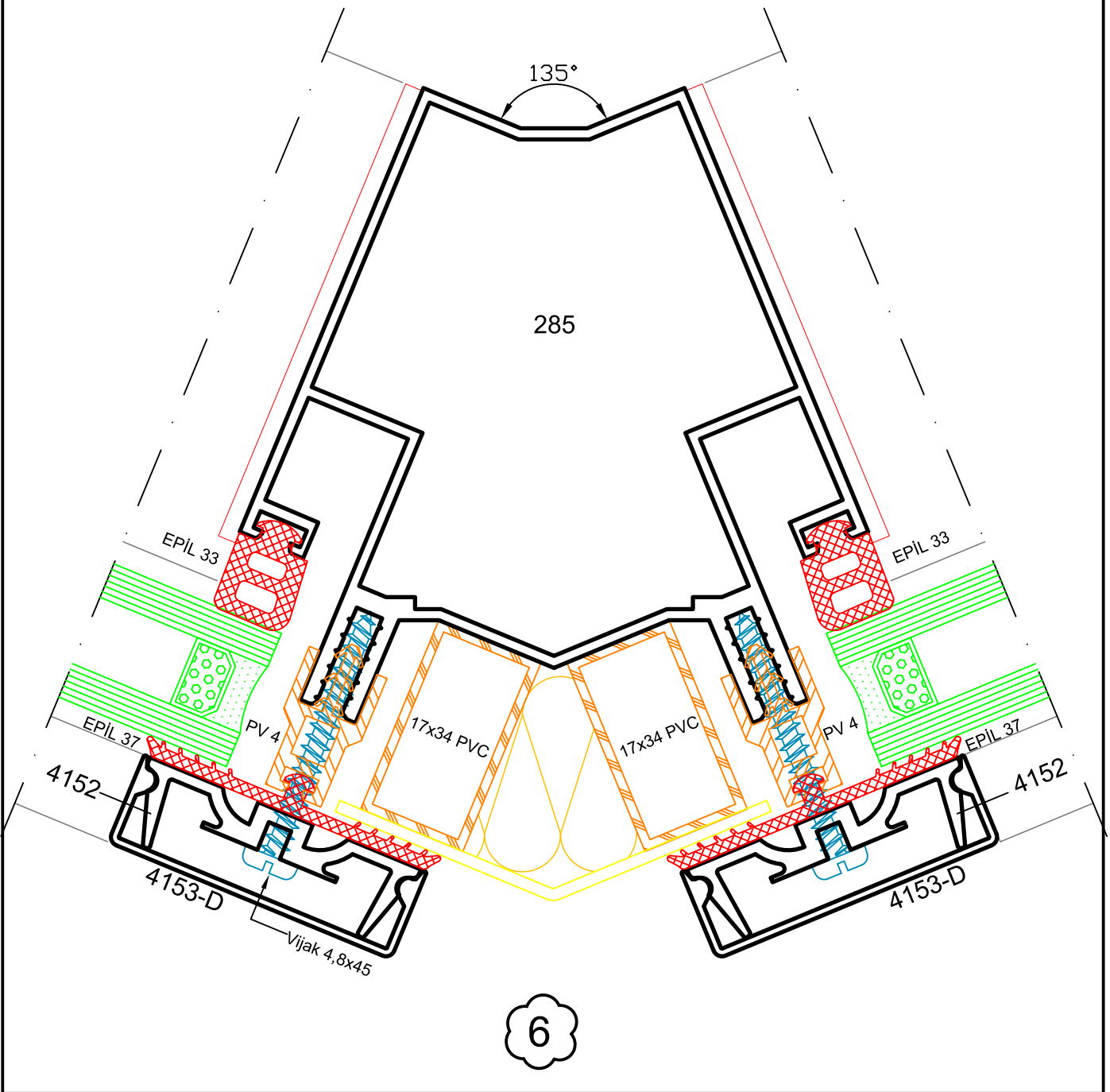
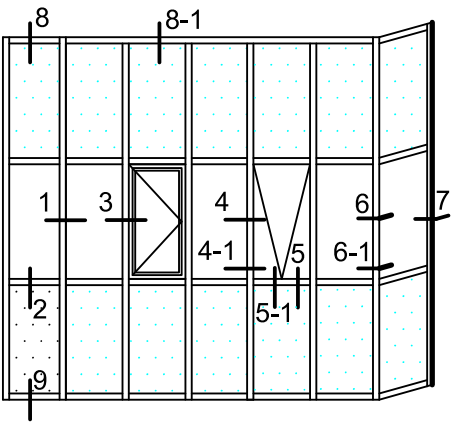

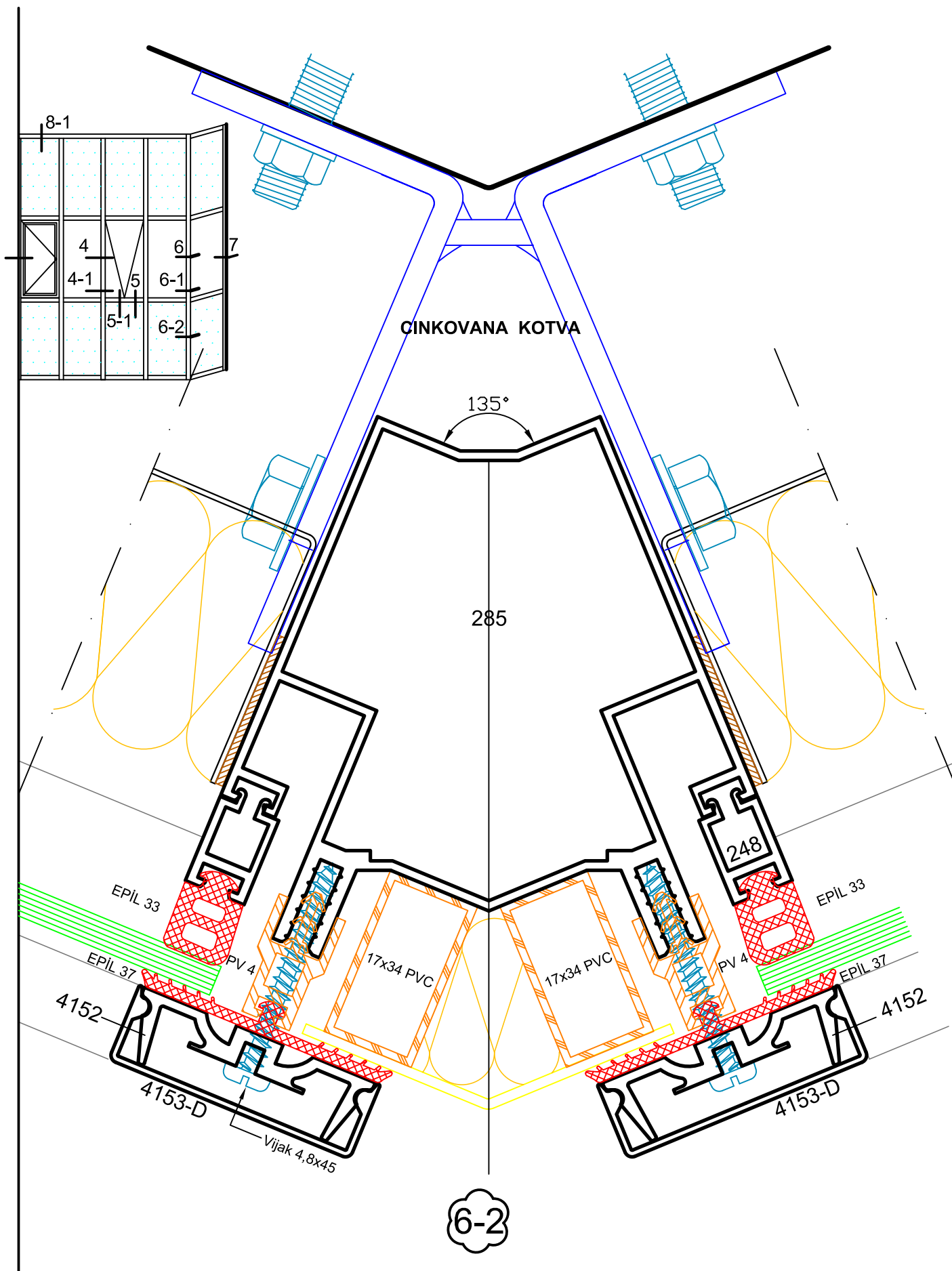

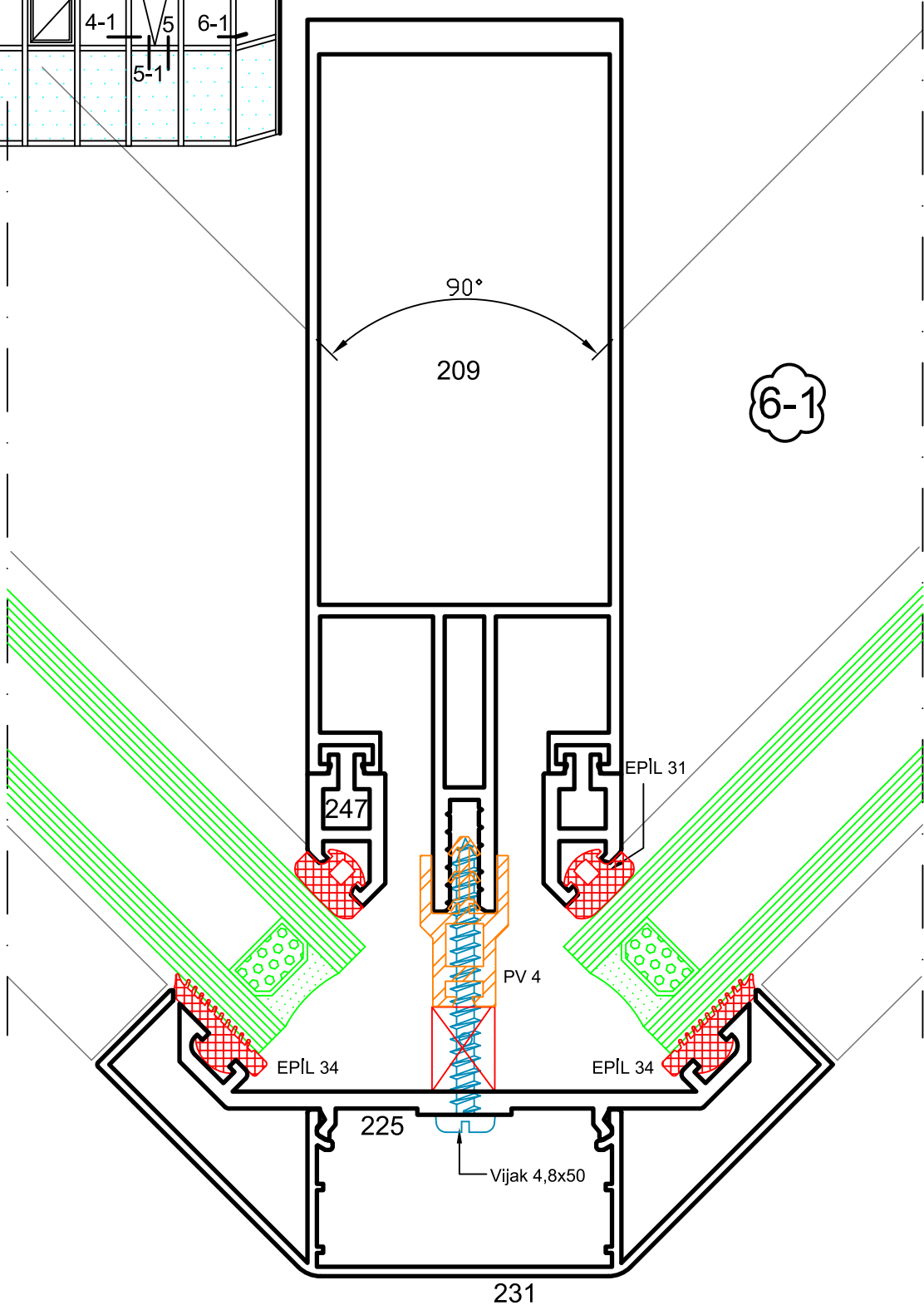
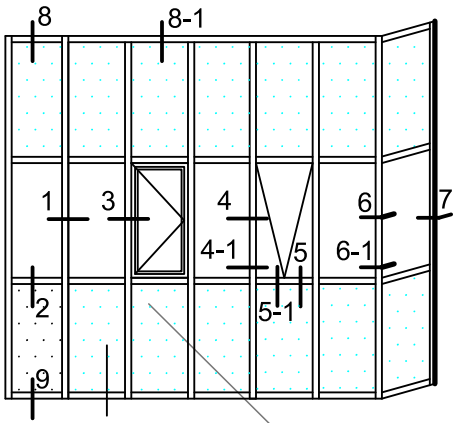

Maximum 14° otvorenog ugla

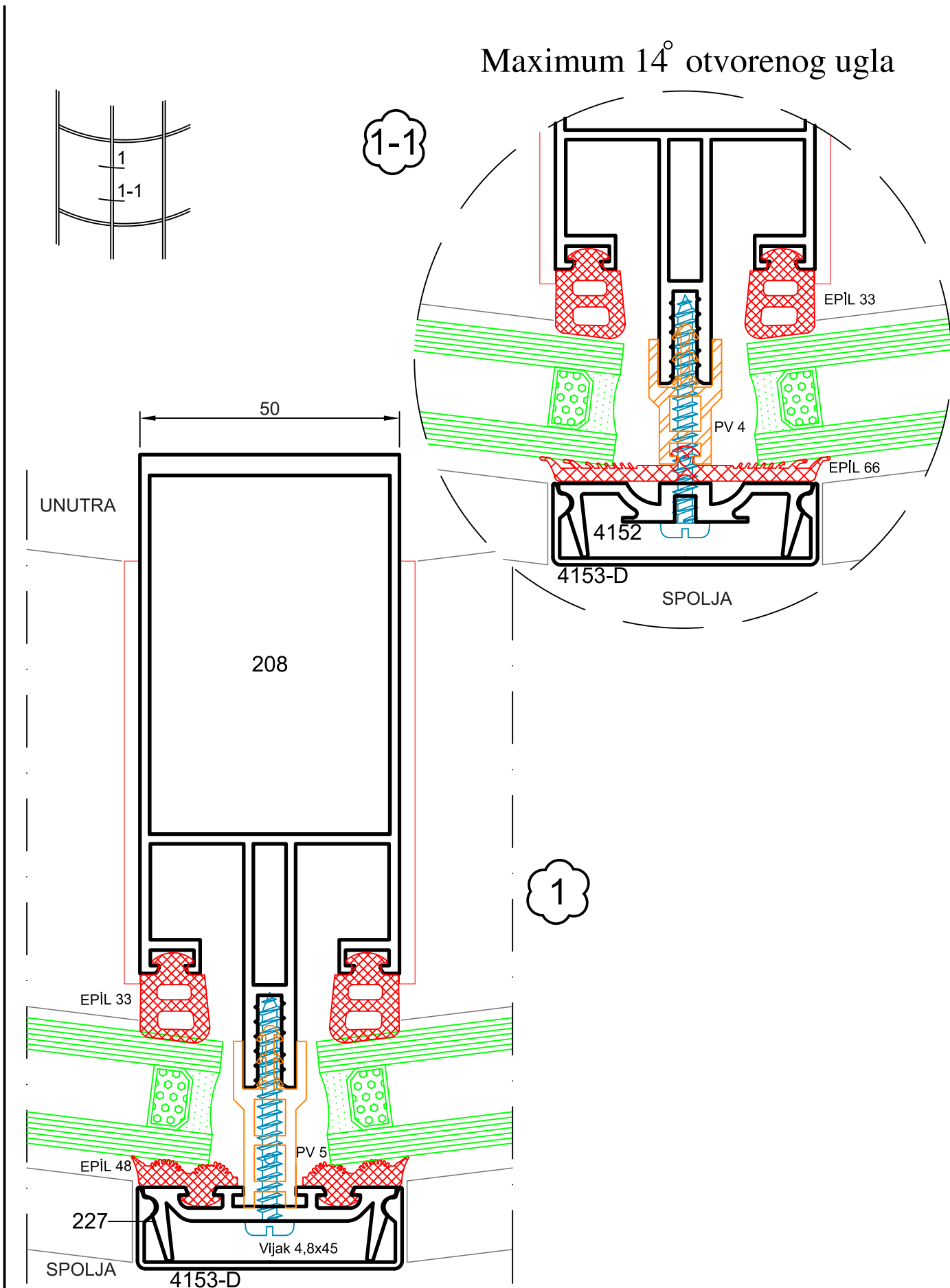

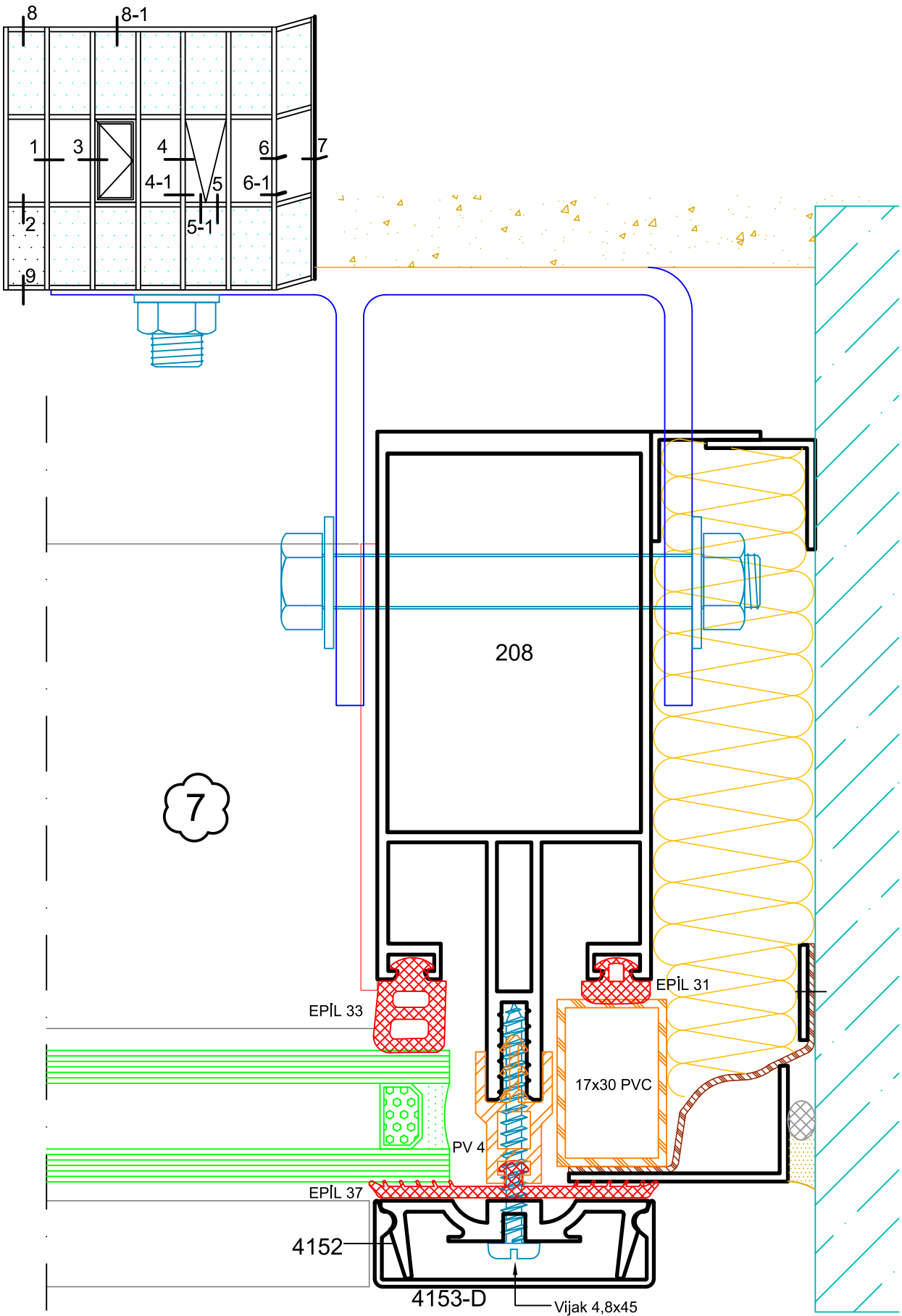

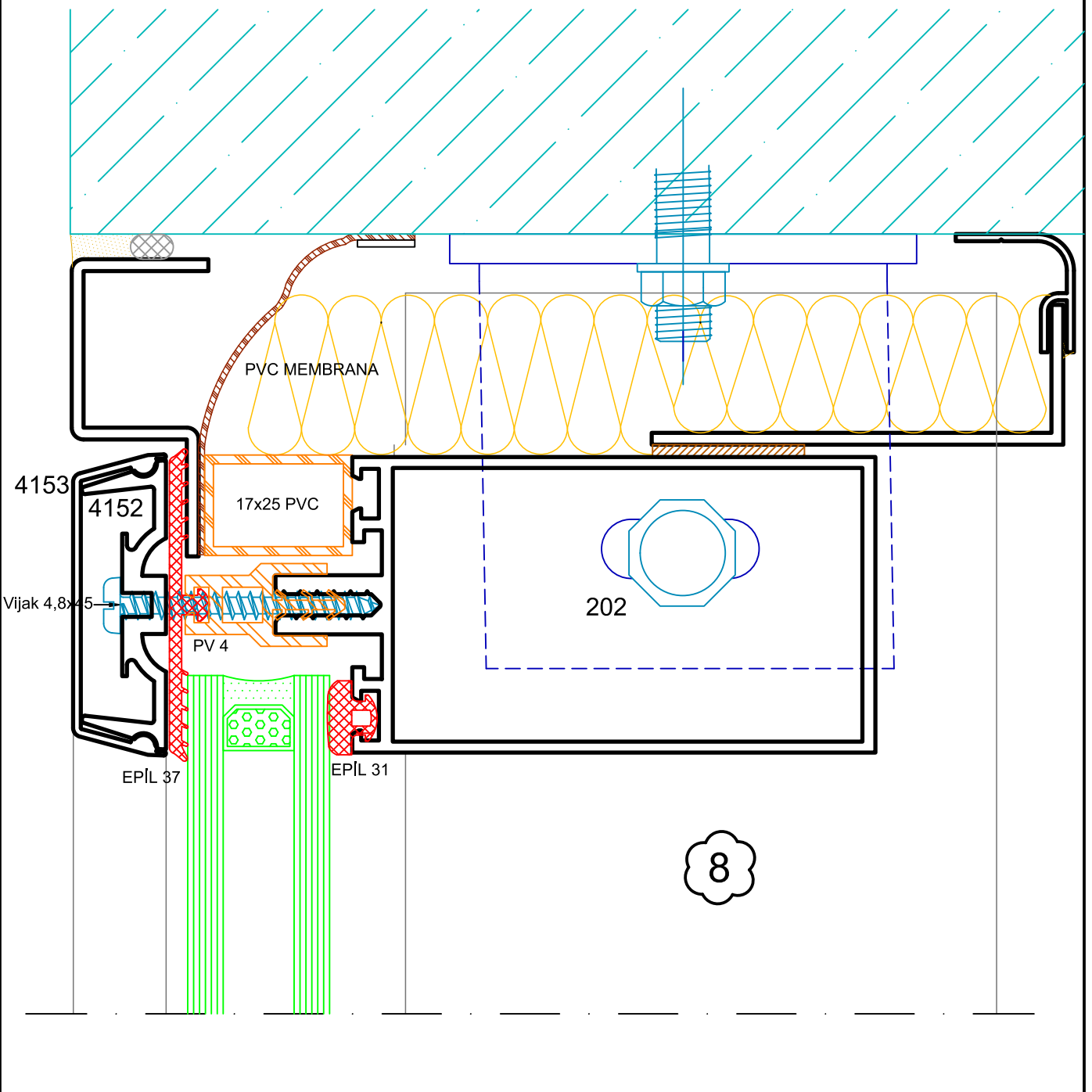
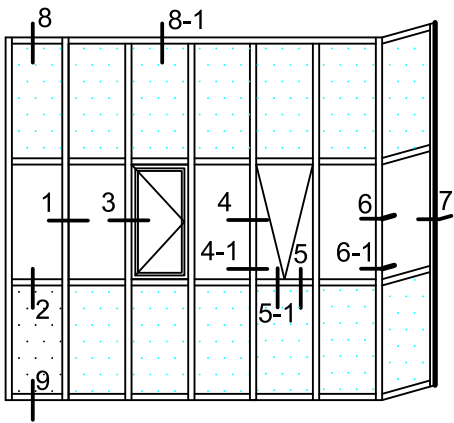

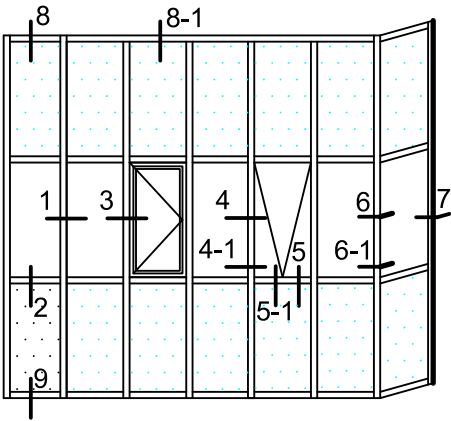

8-1

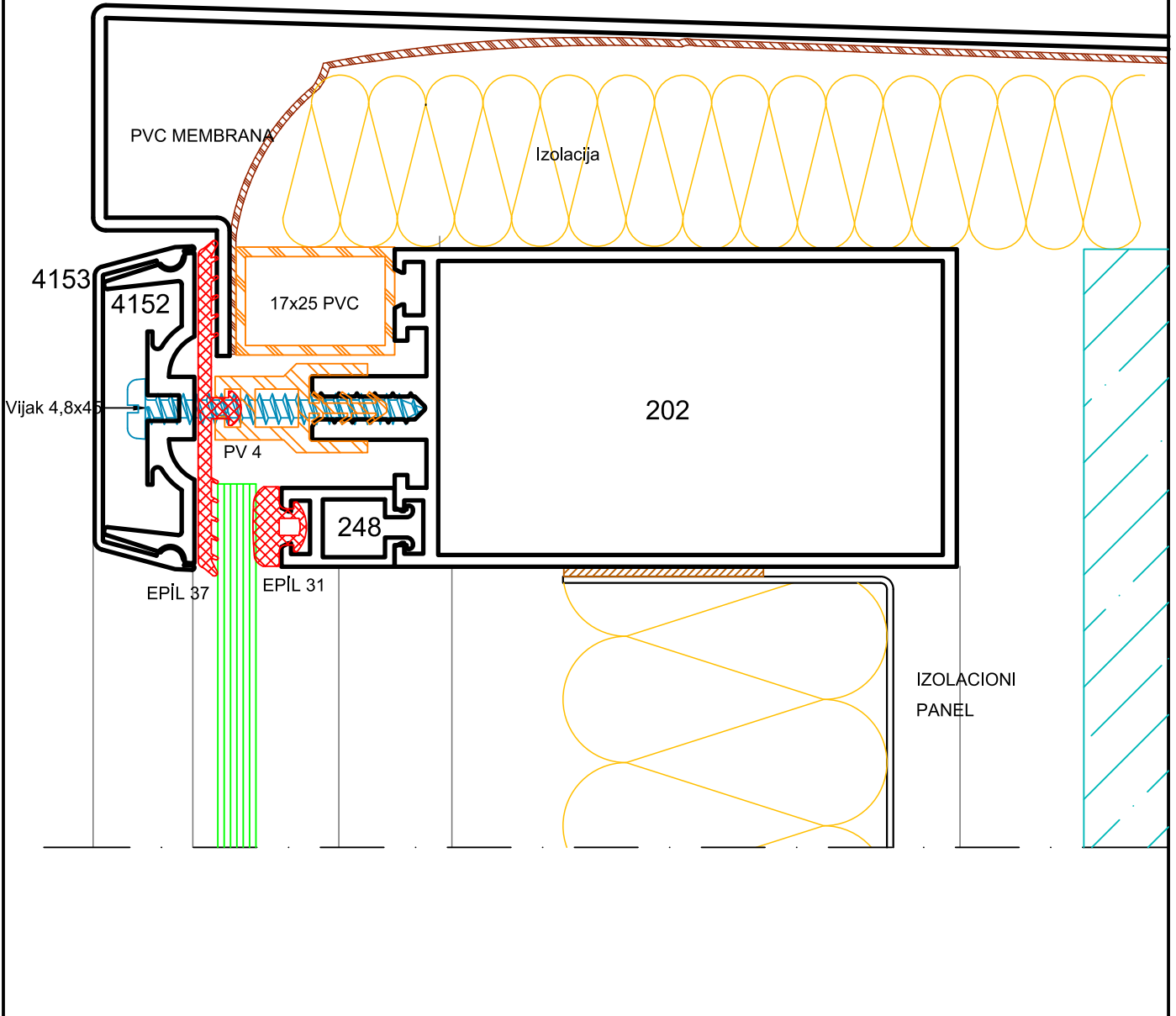



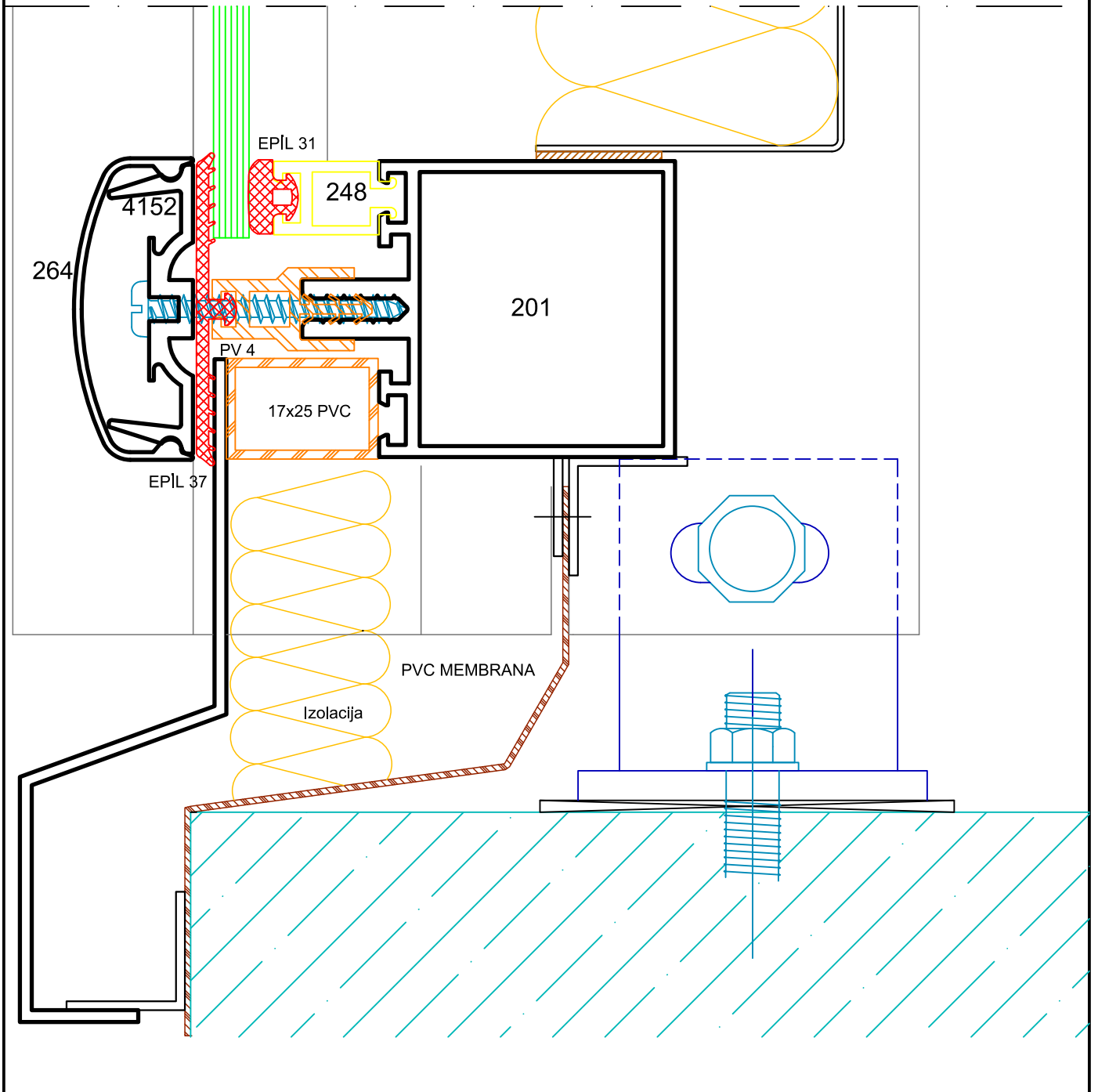
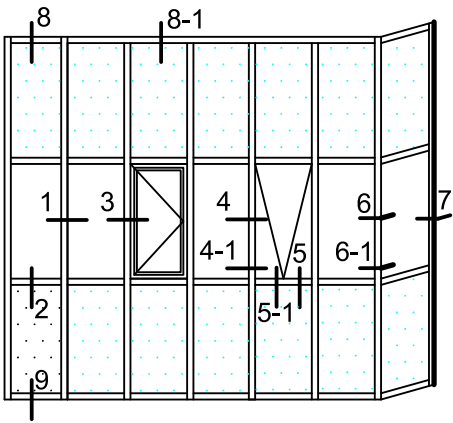

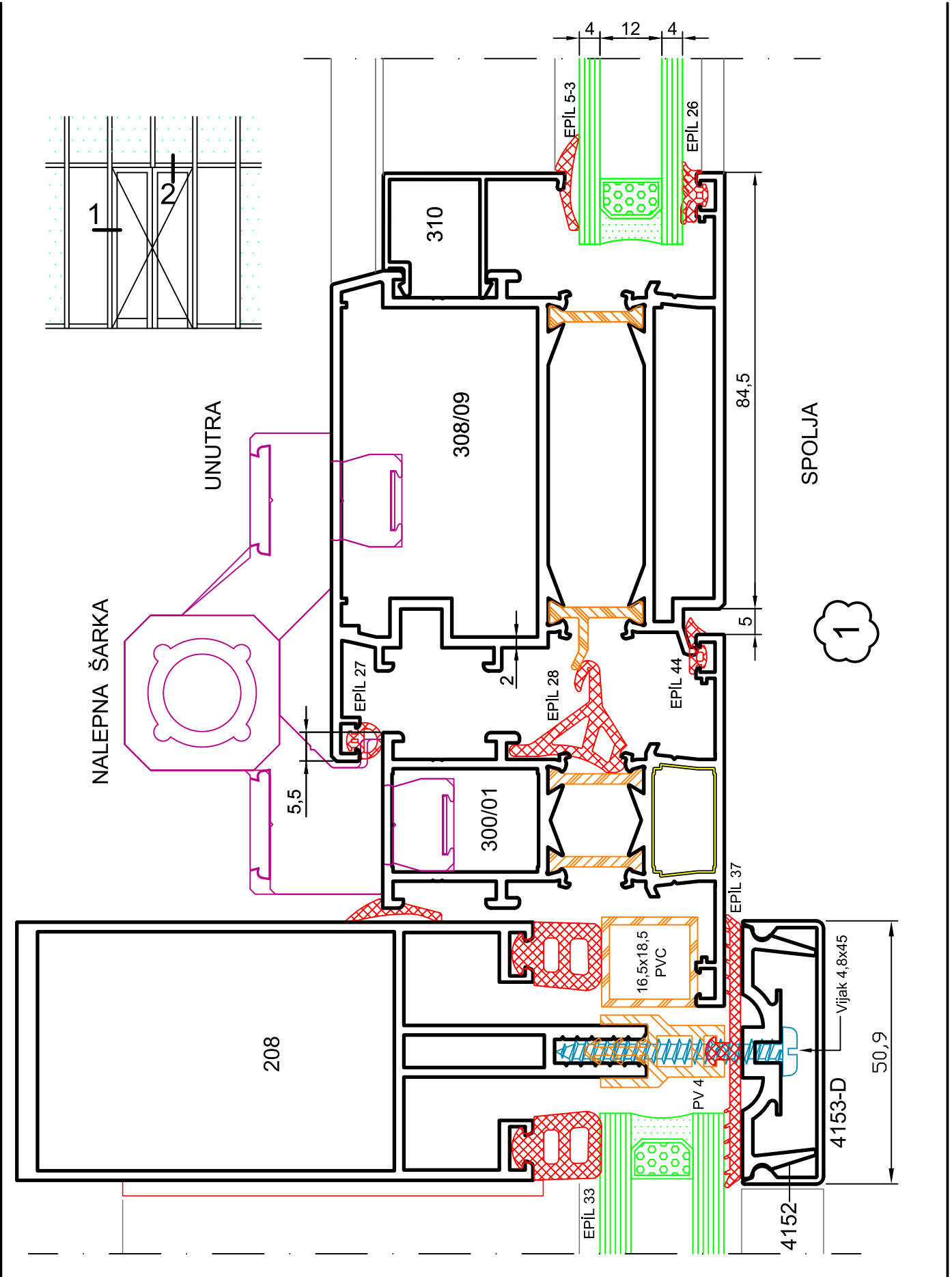

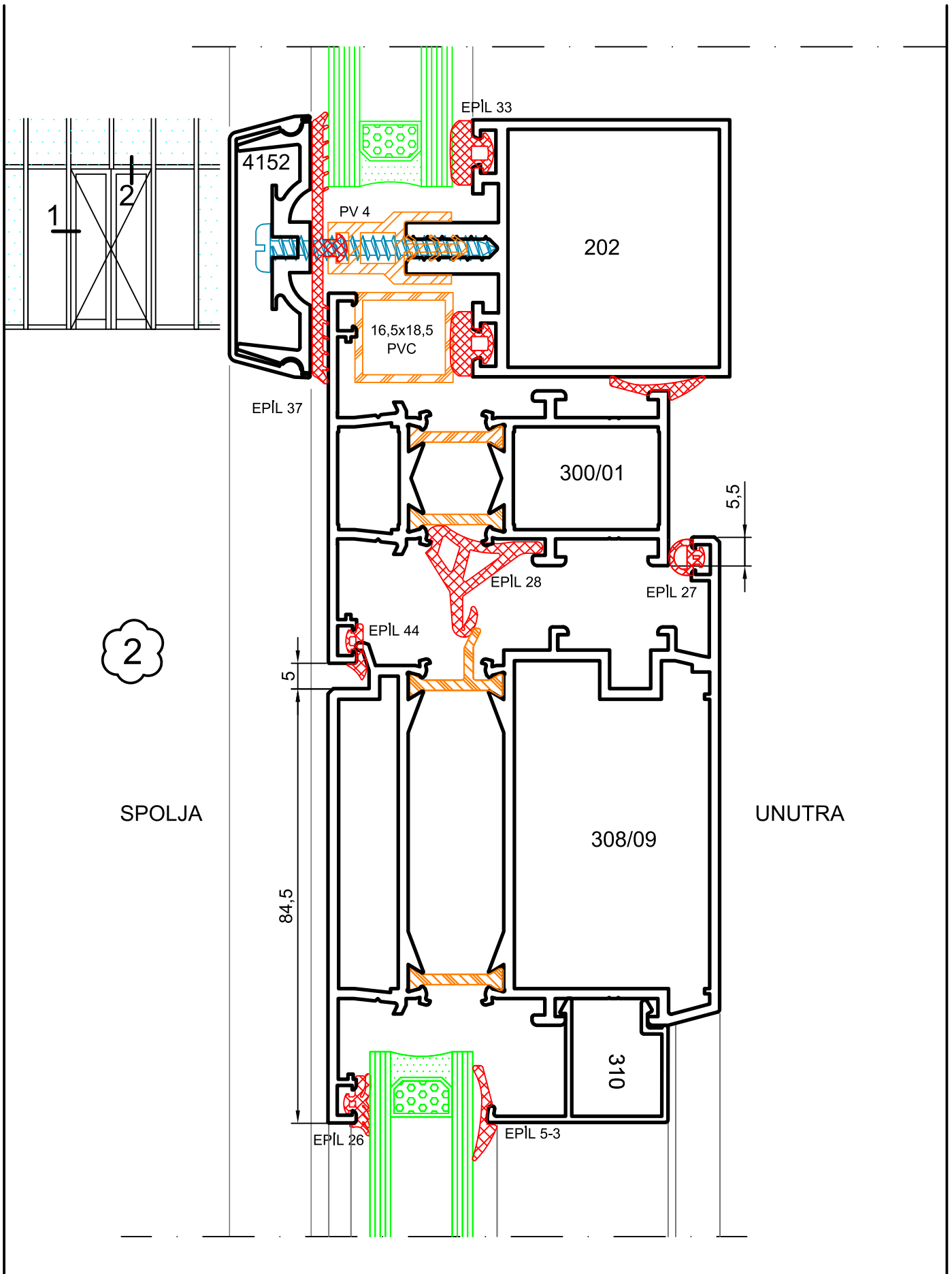

**POKLOPCI RAVNI**

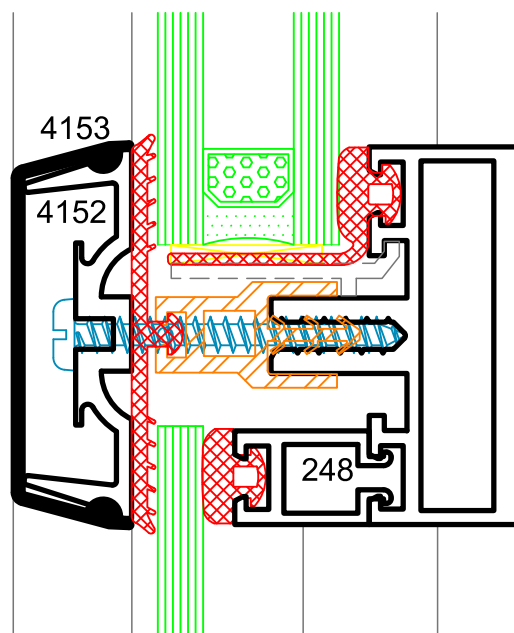
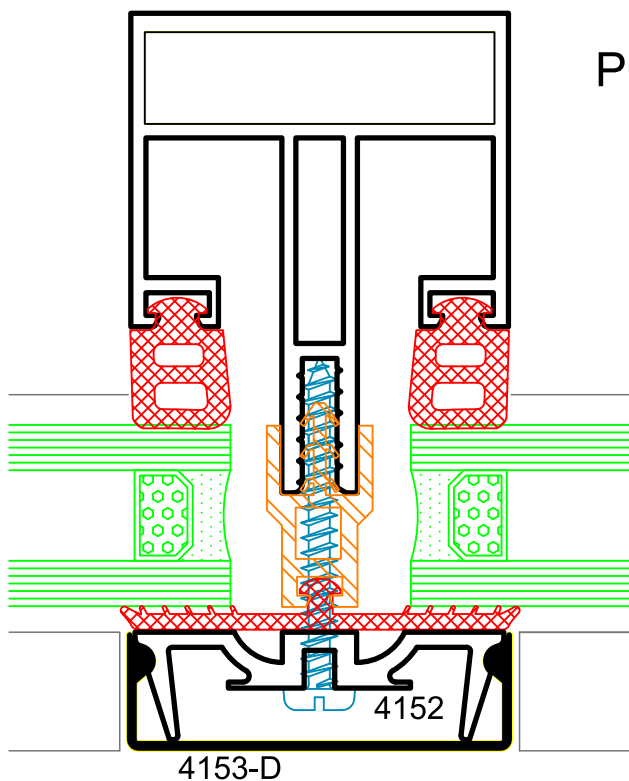

**POKLOPCI OVALNI**

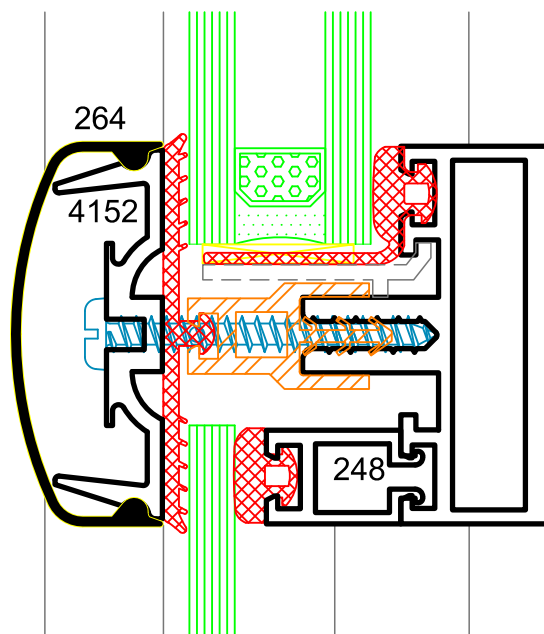
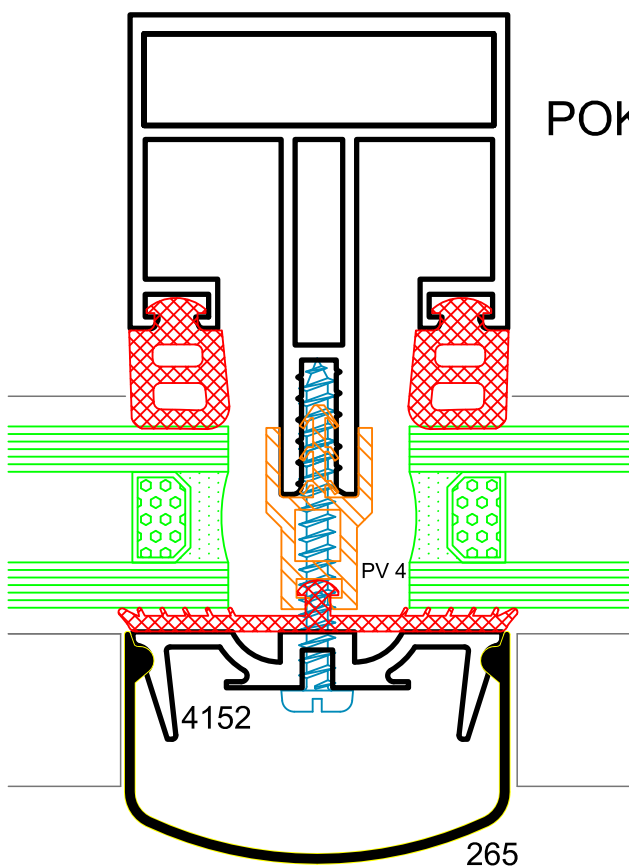

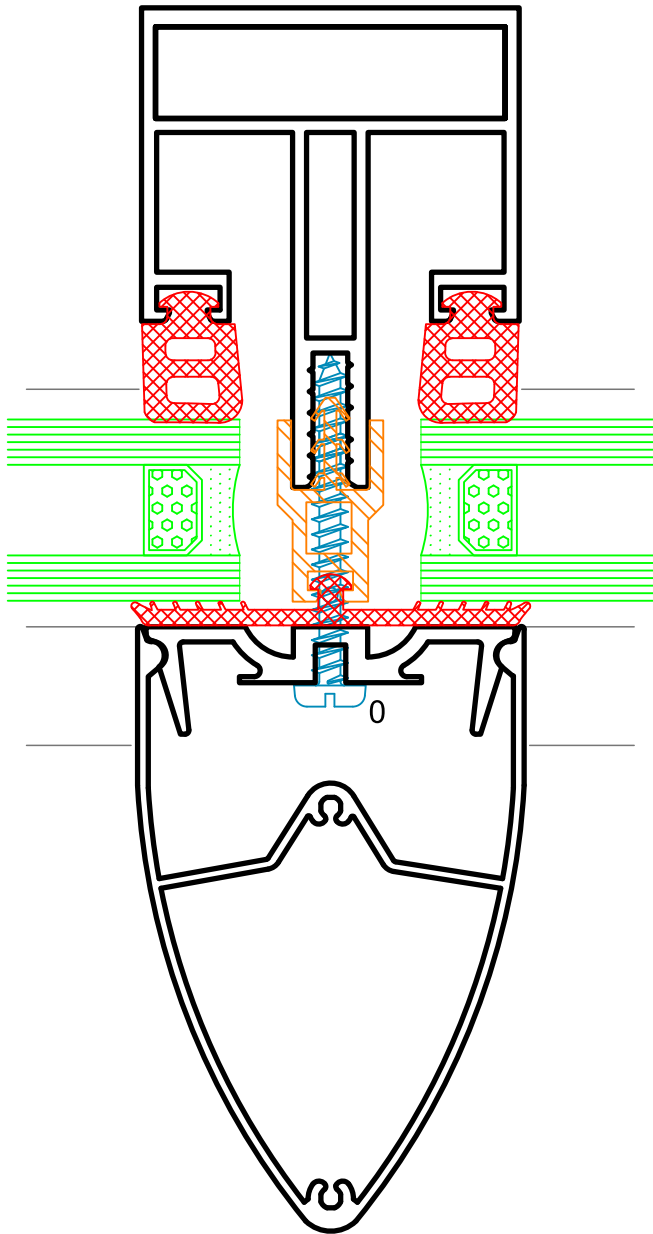

Poklopac badem

Poklopac krovni

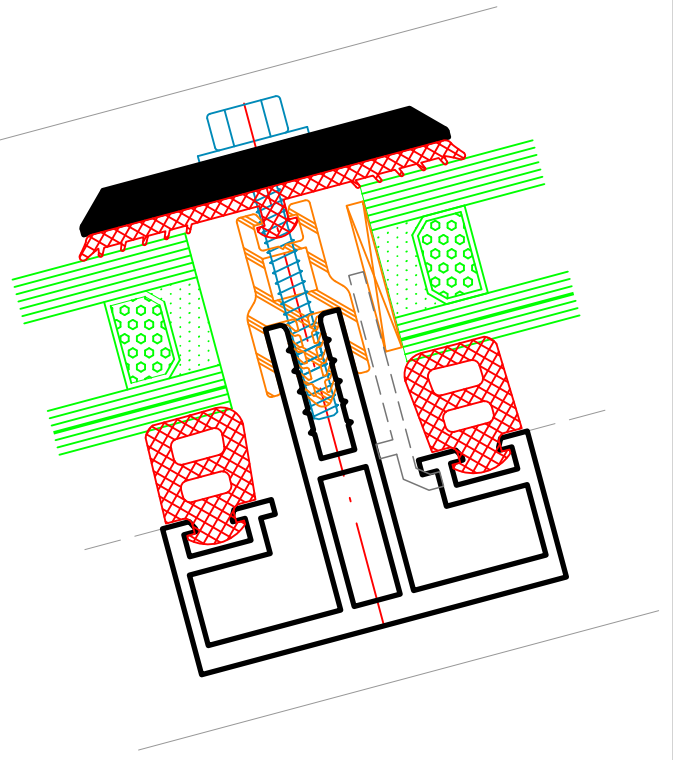

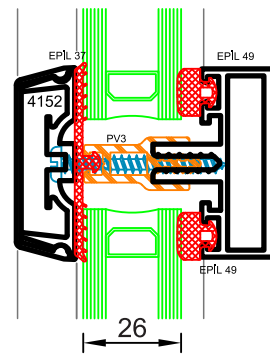
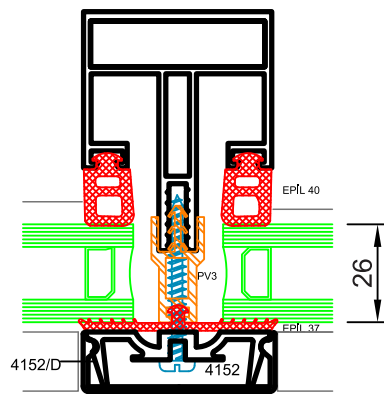
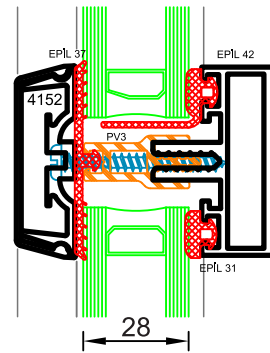
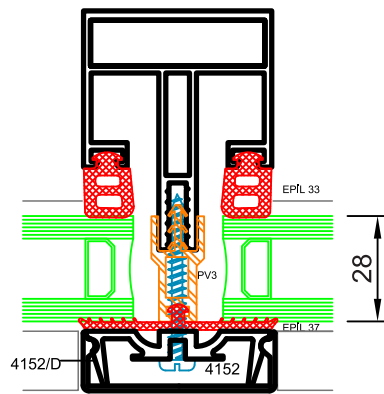
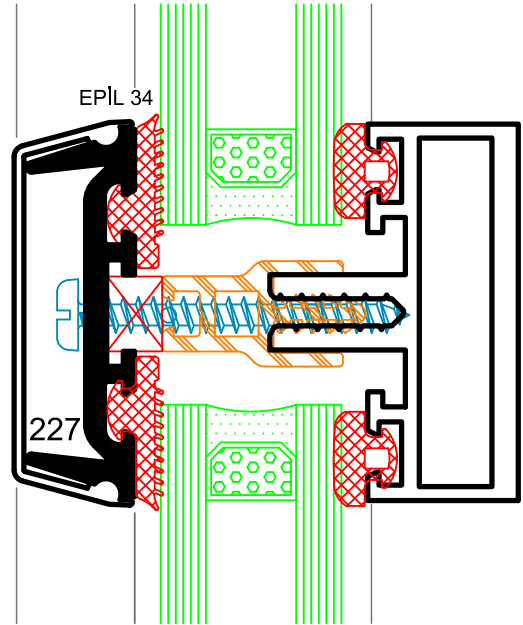
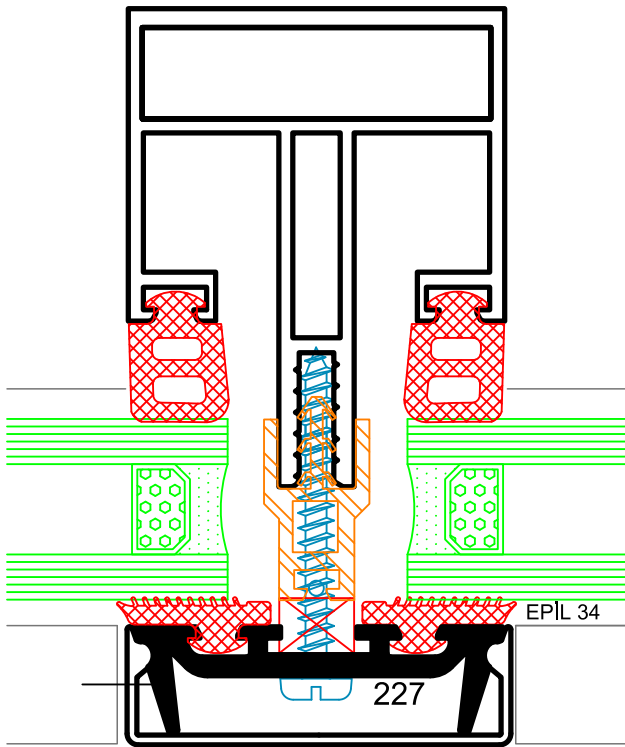

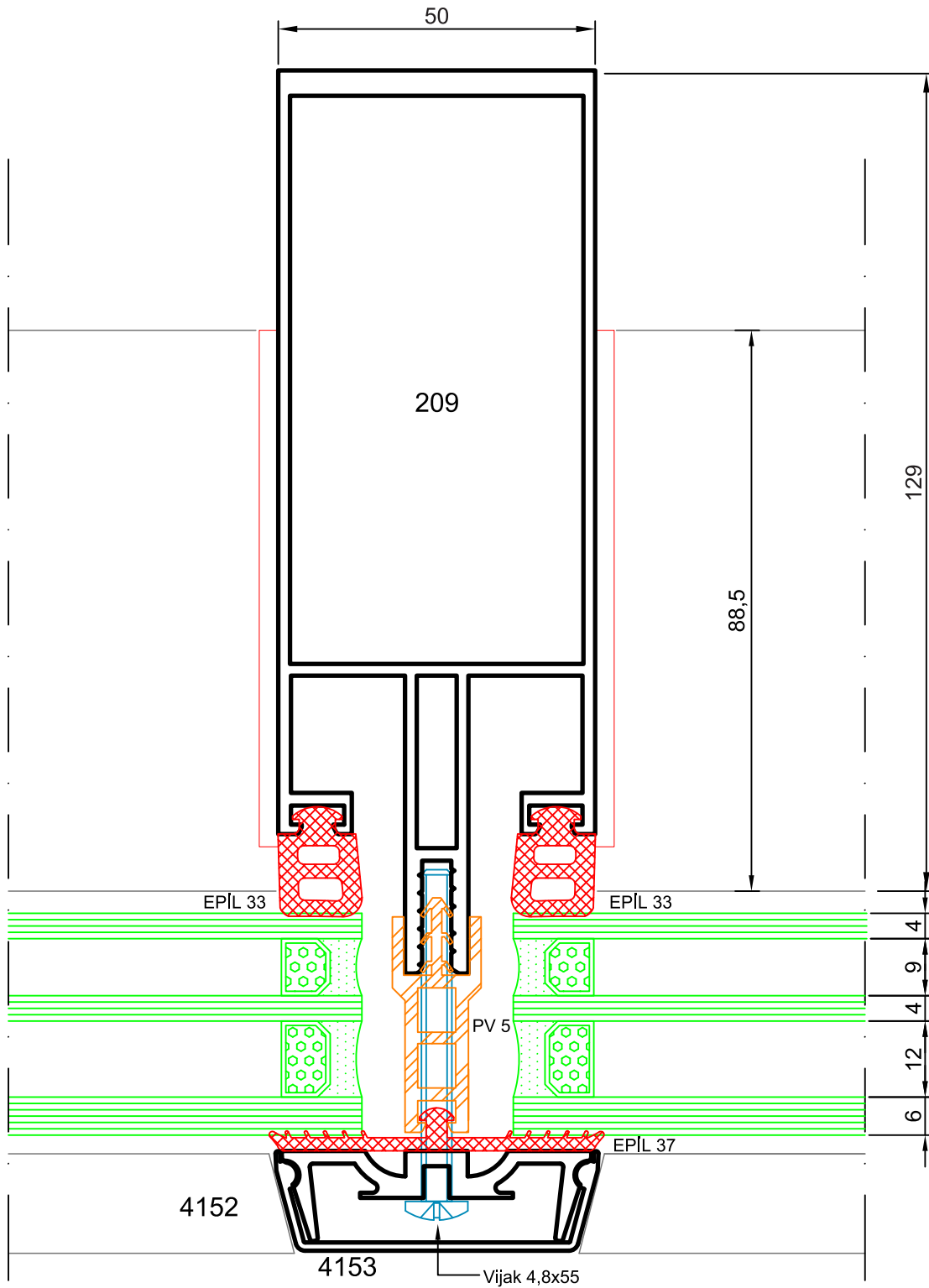

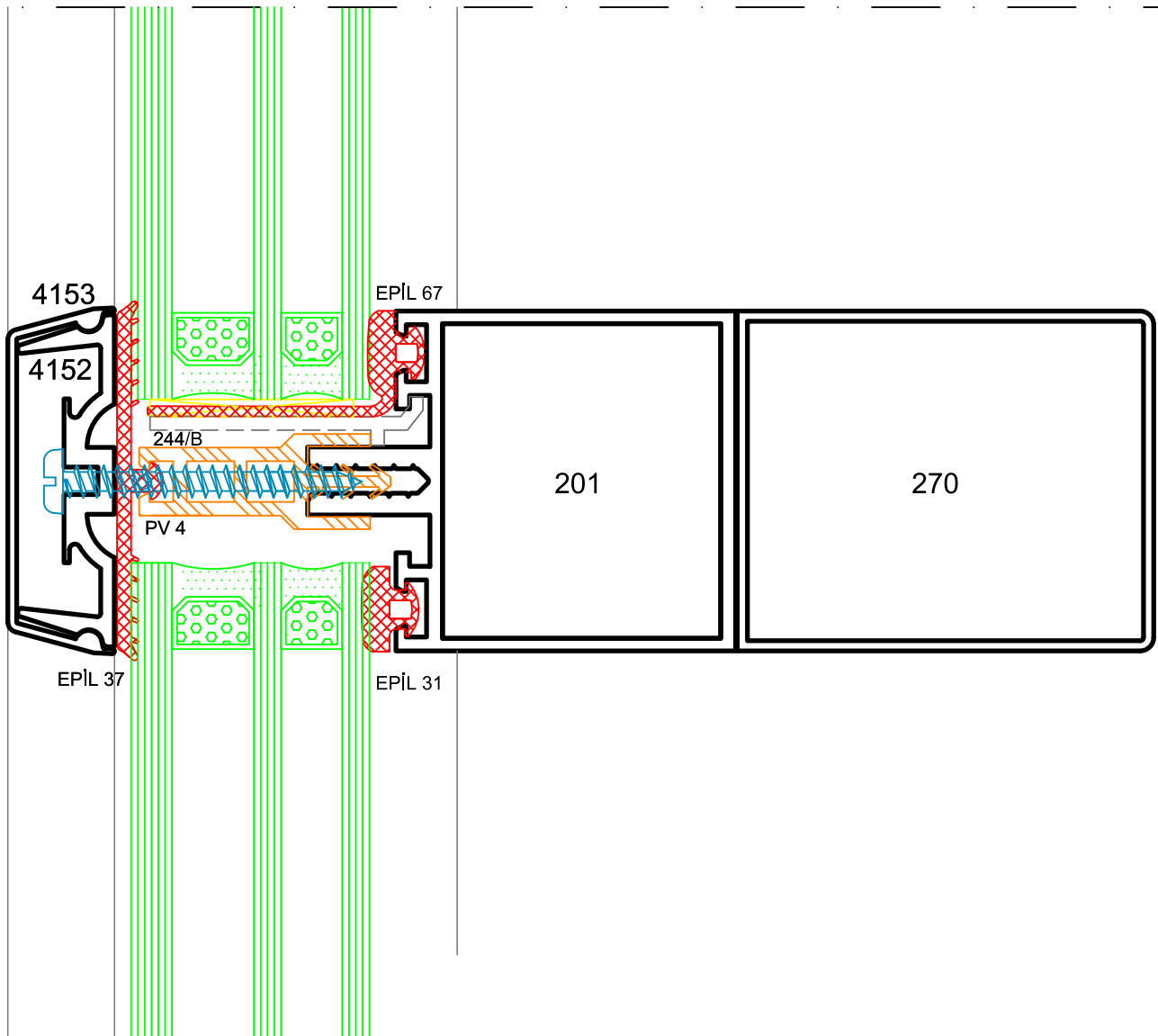



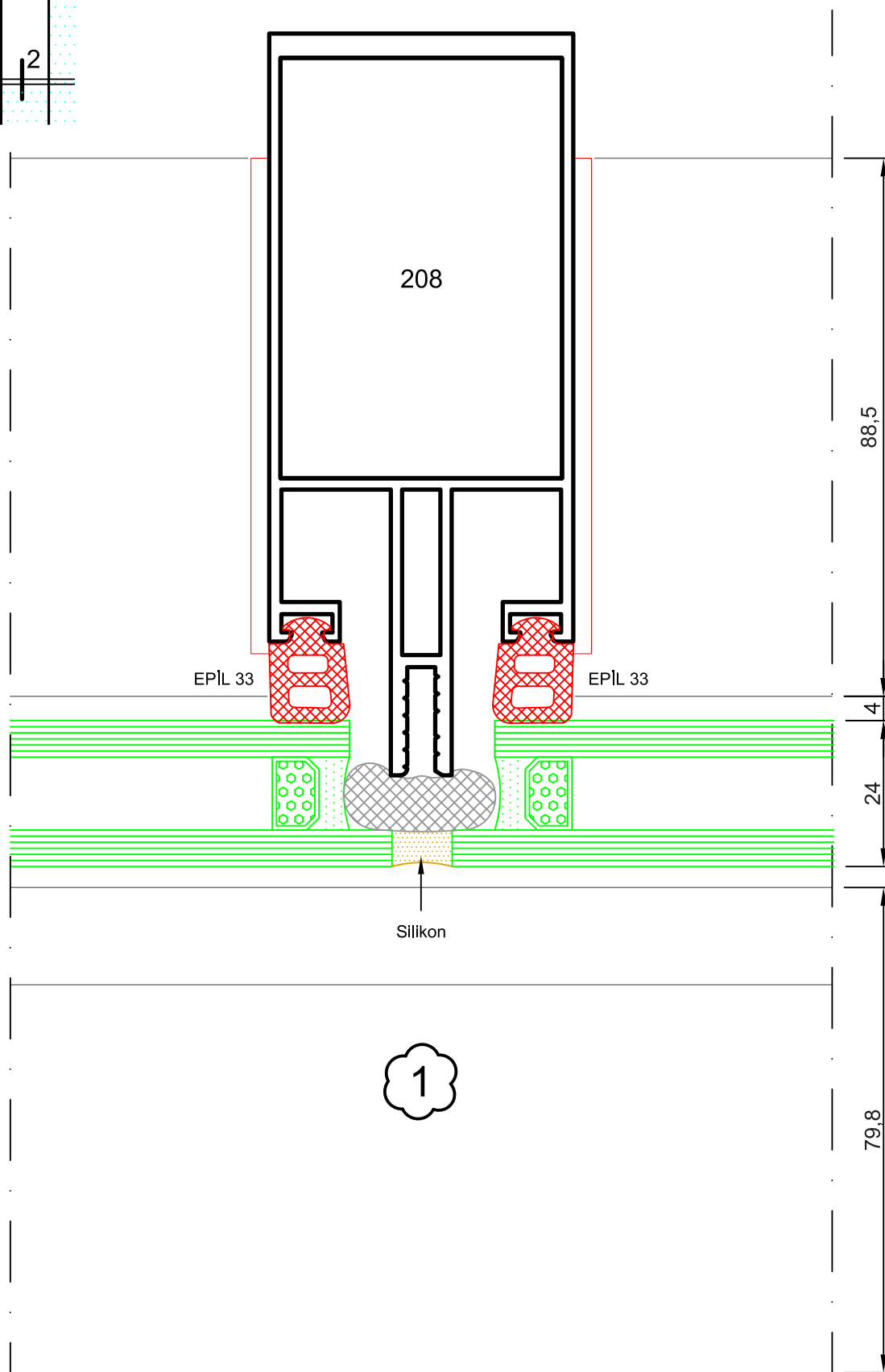
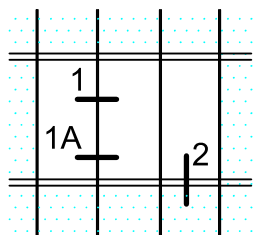

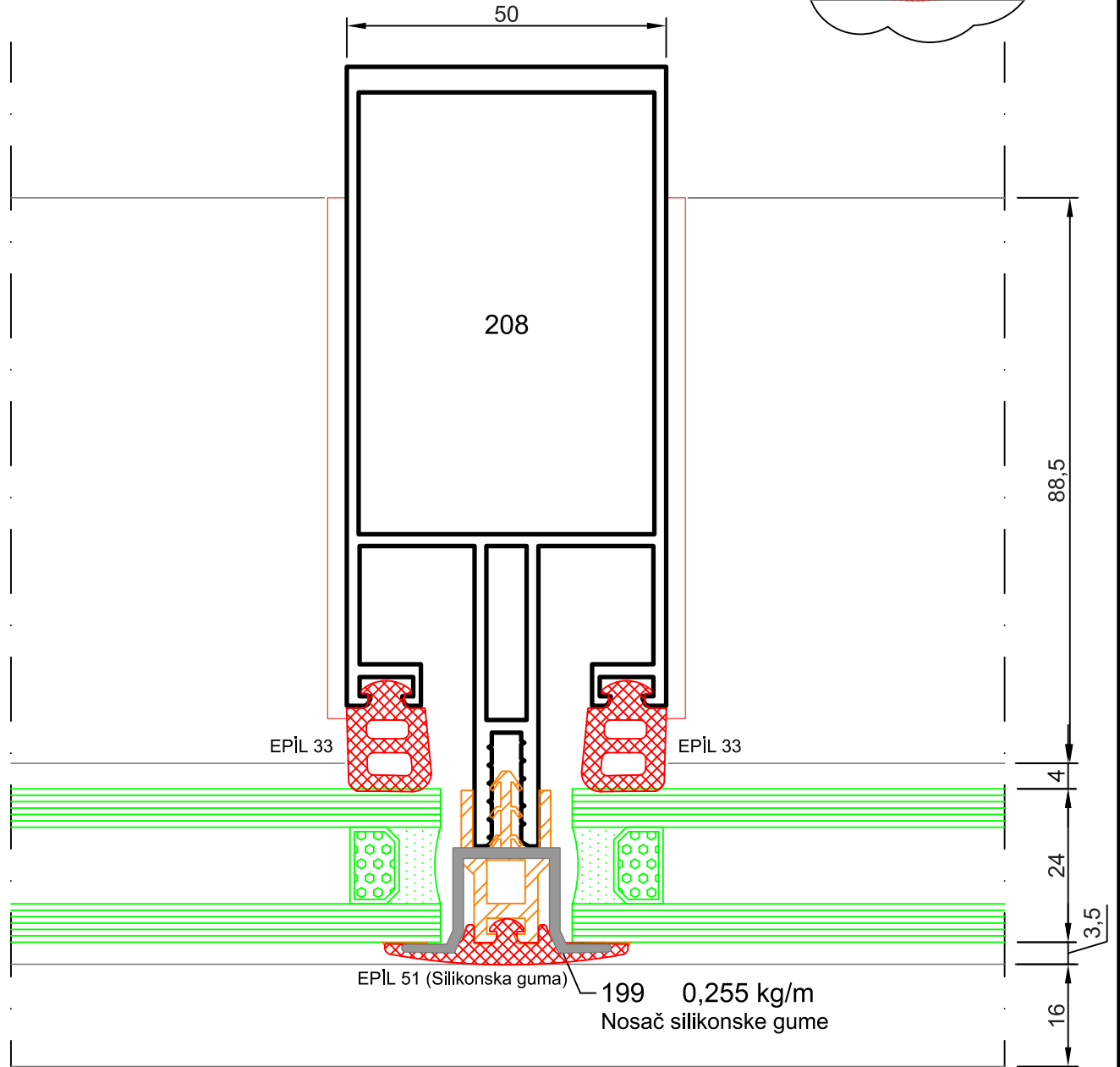
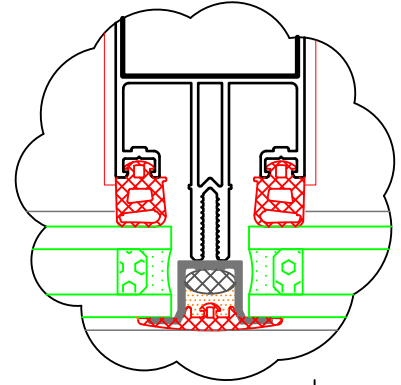
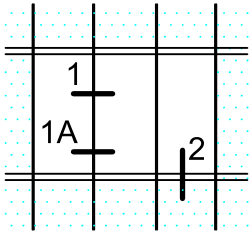

1A

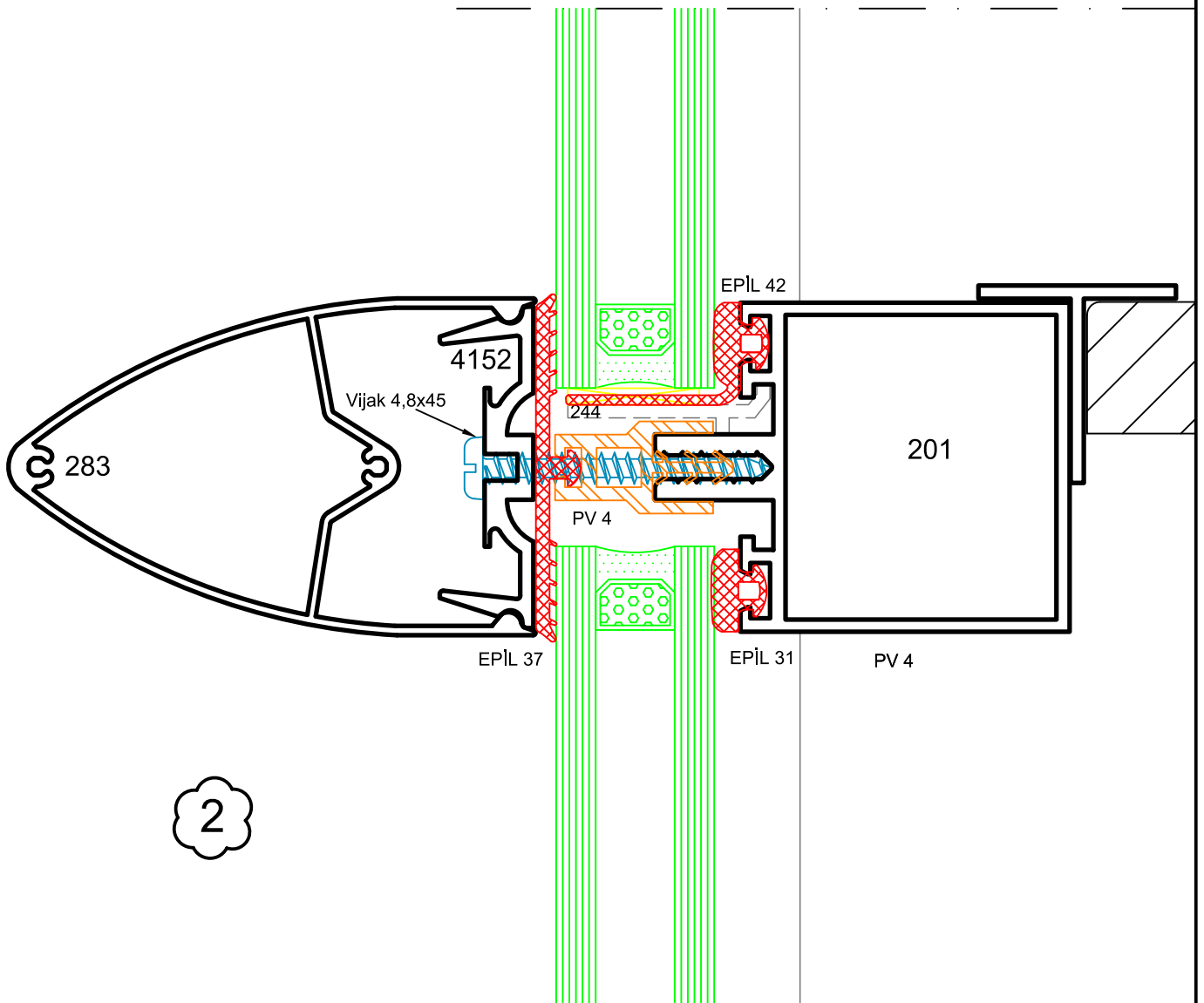
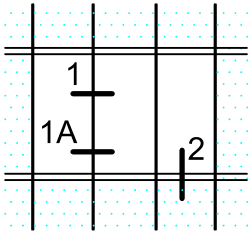

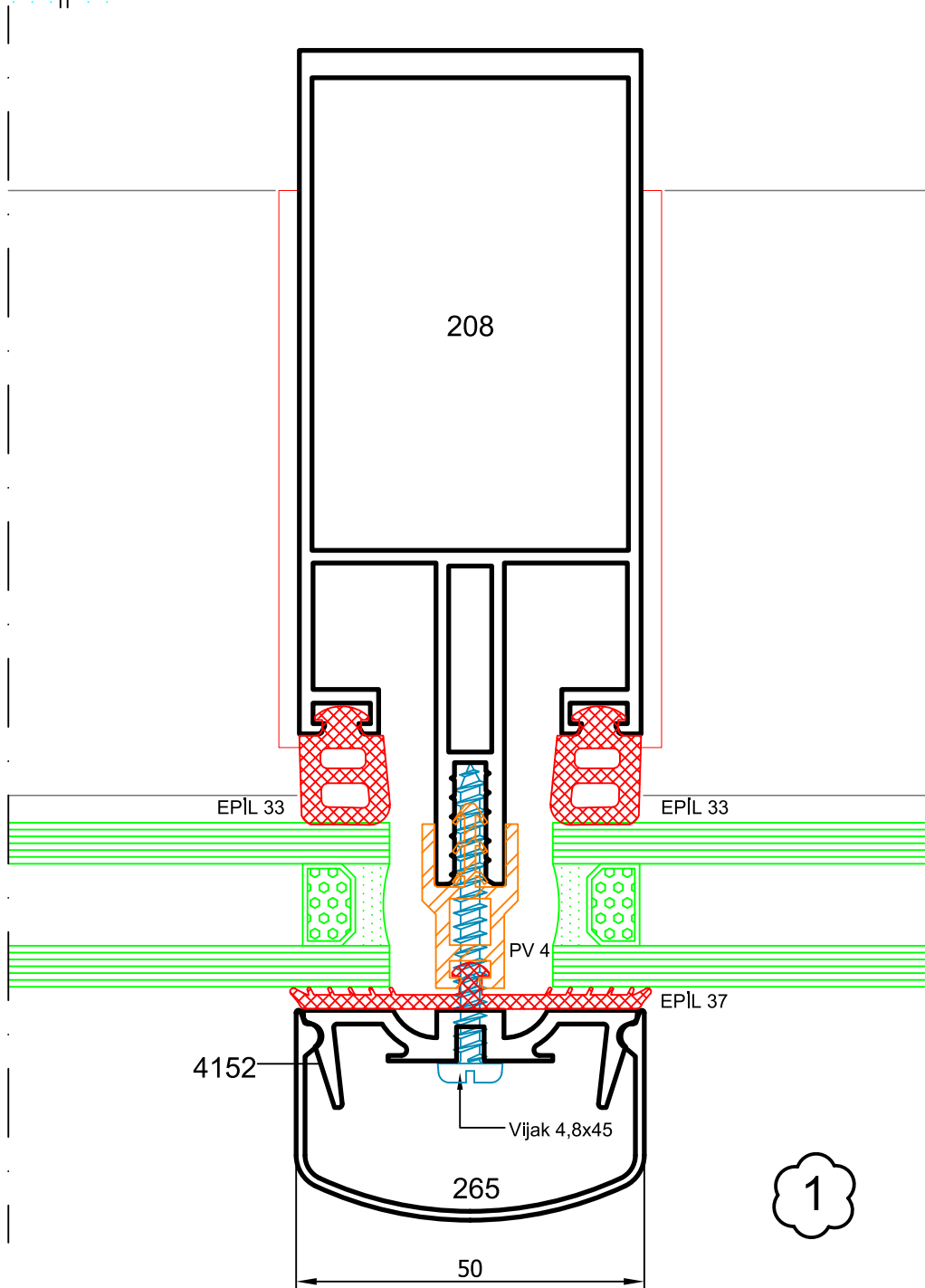
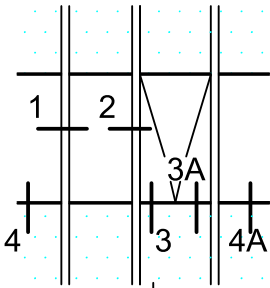

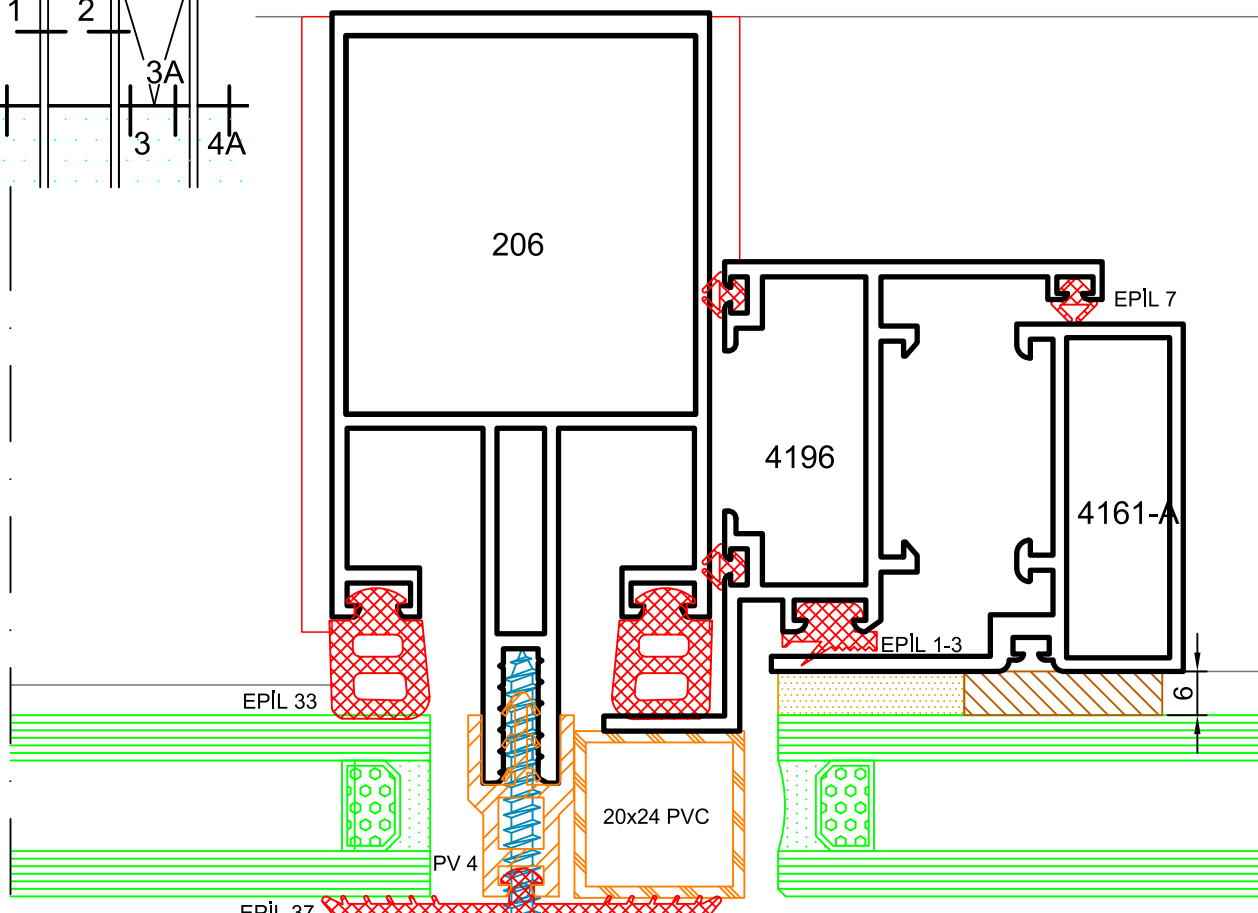
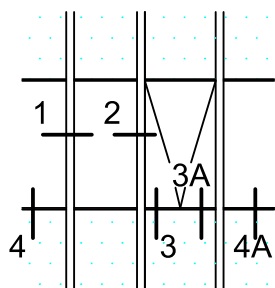

2

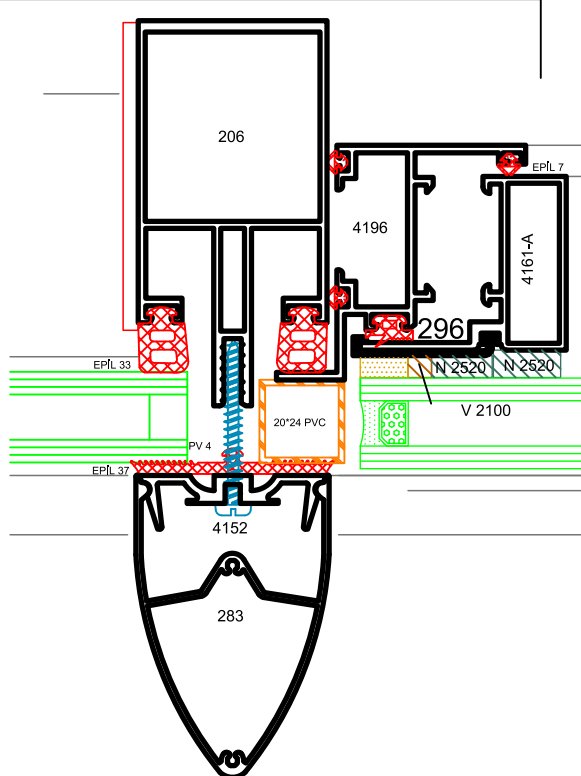

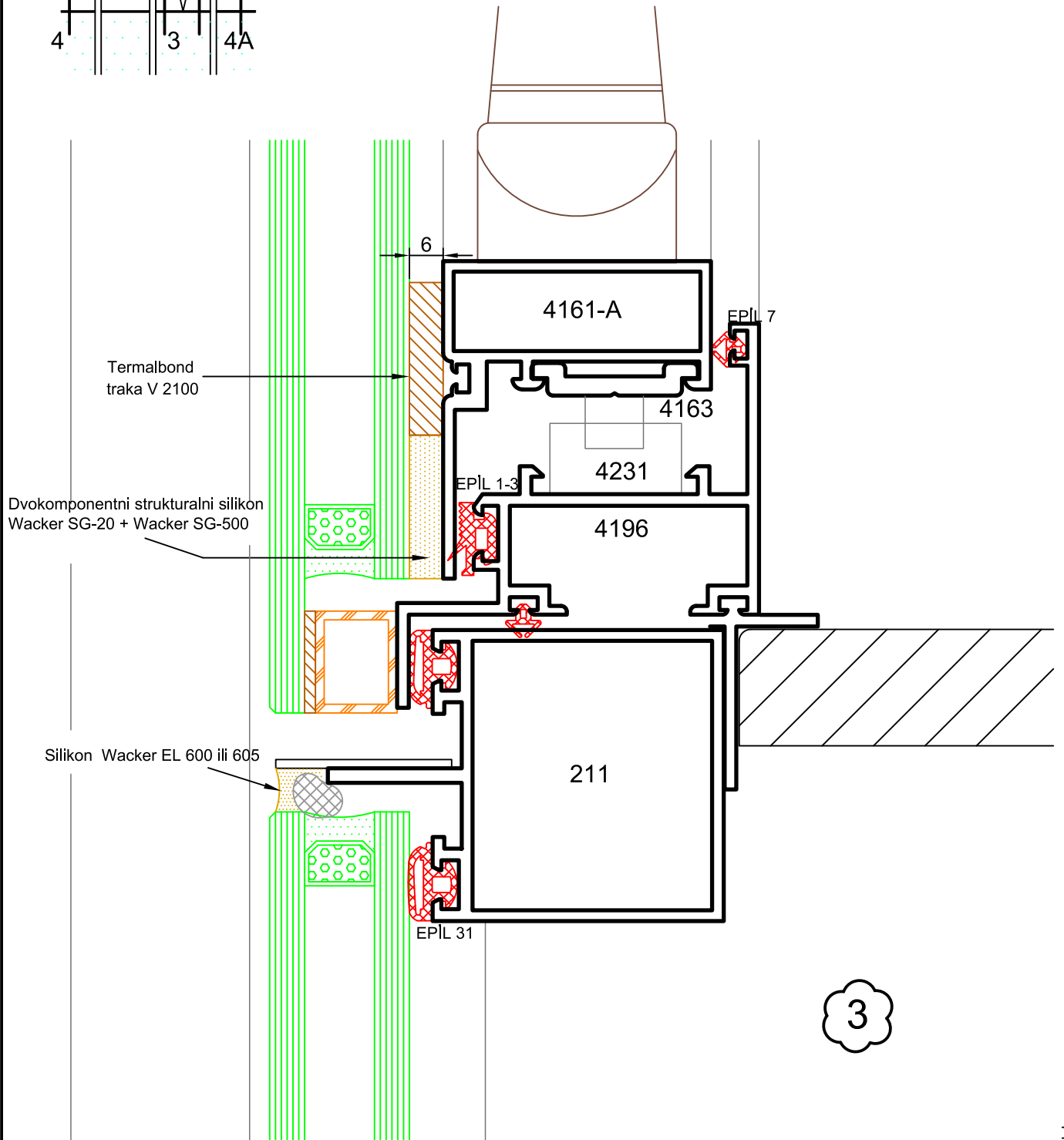
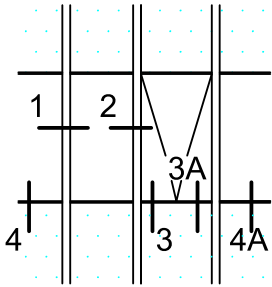

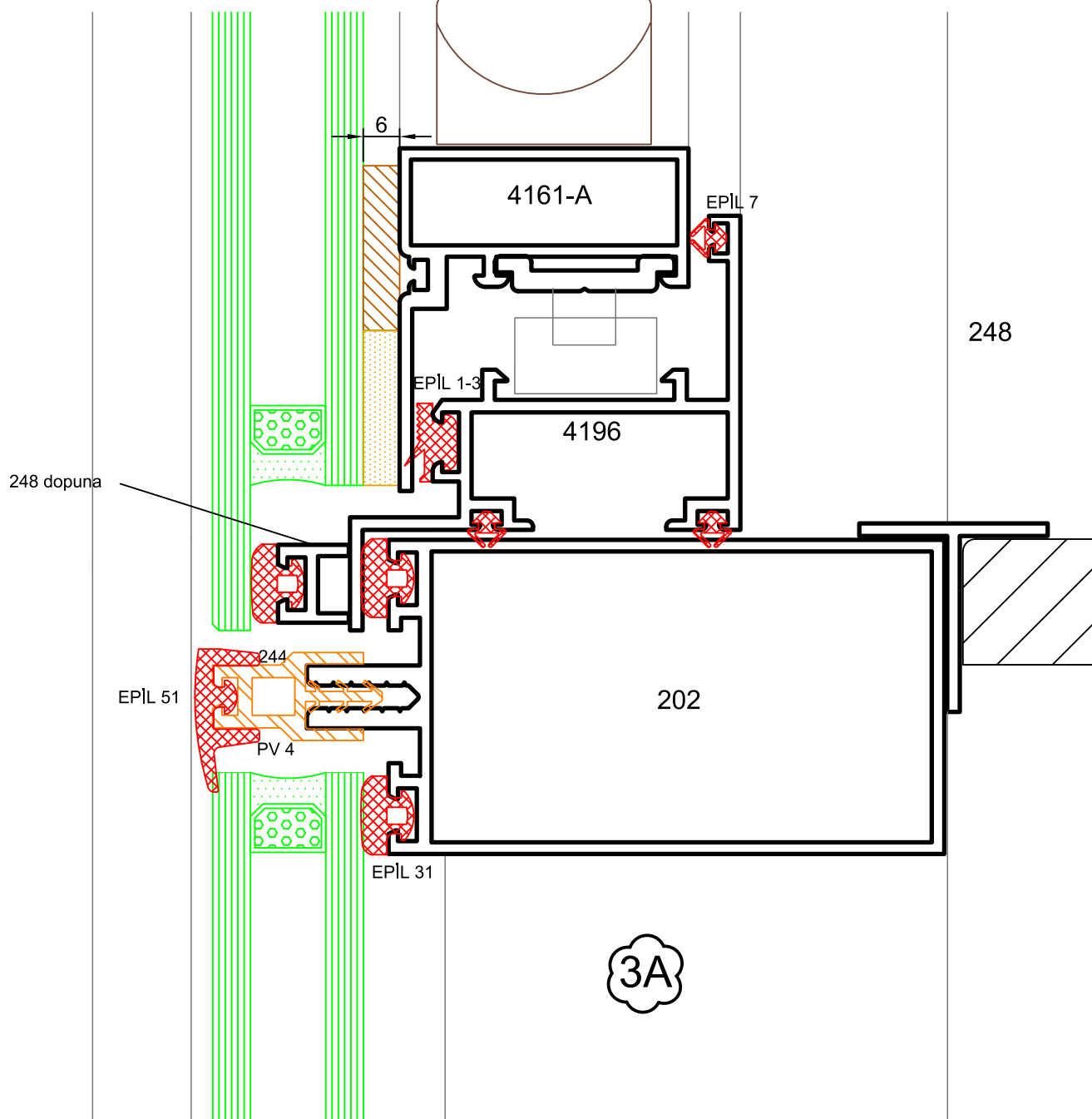
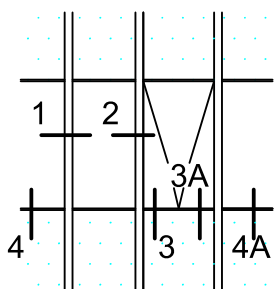

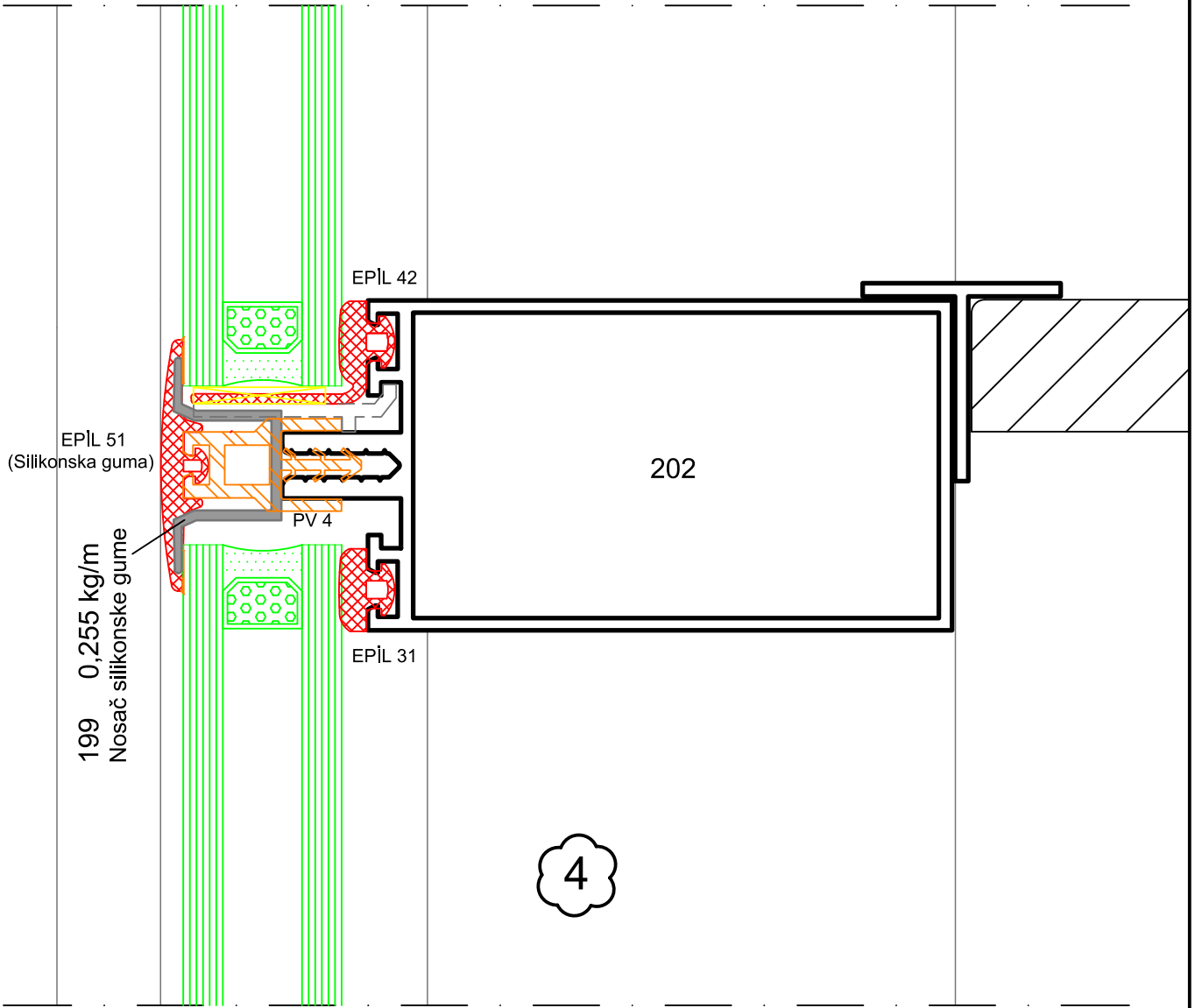
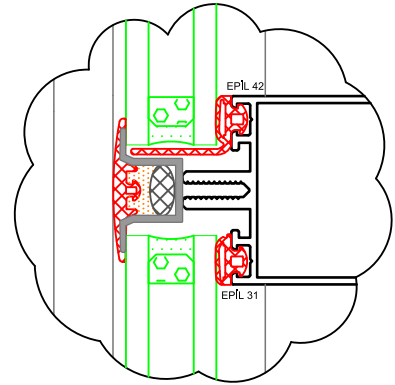
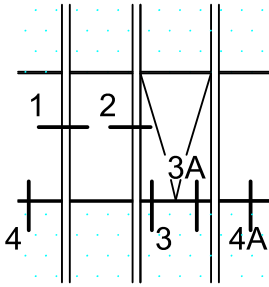



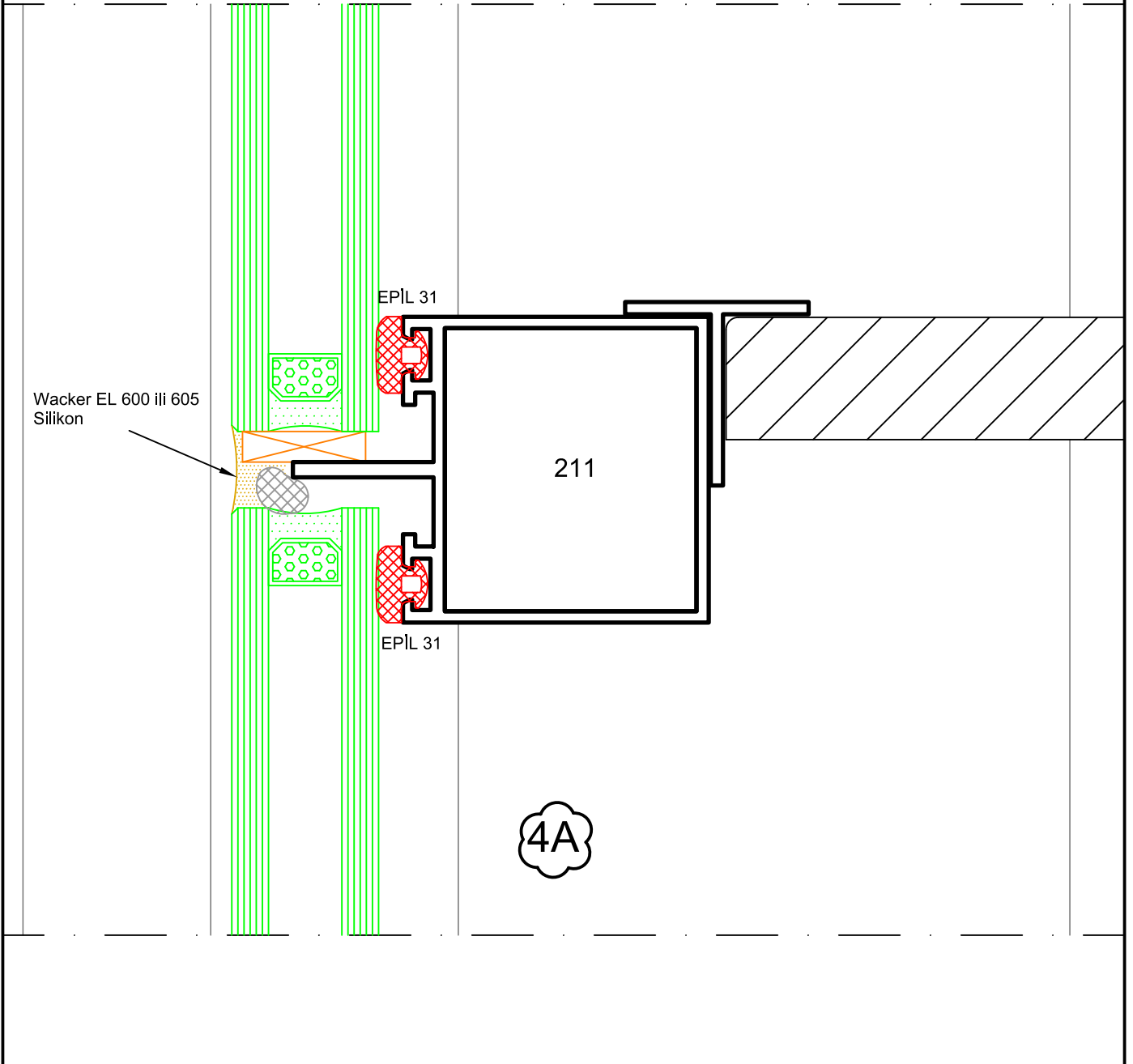
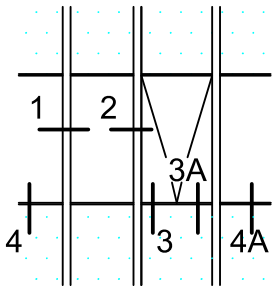

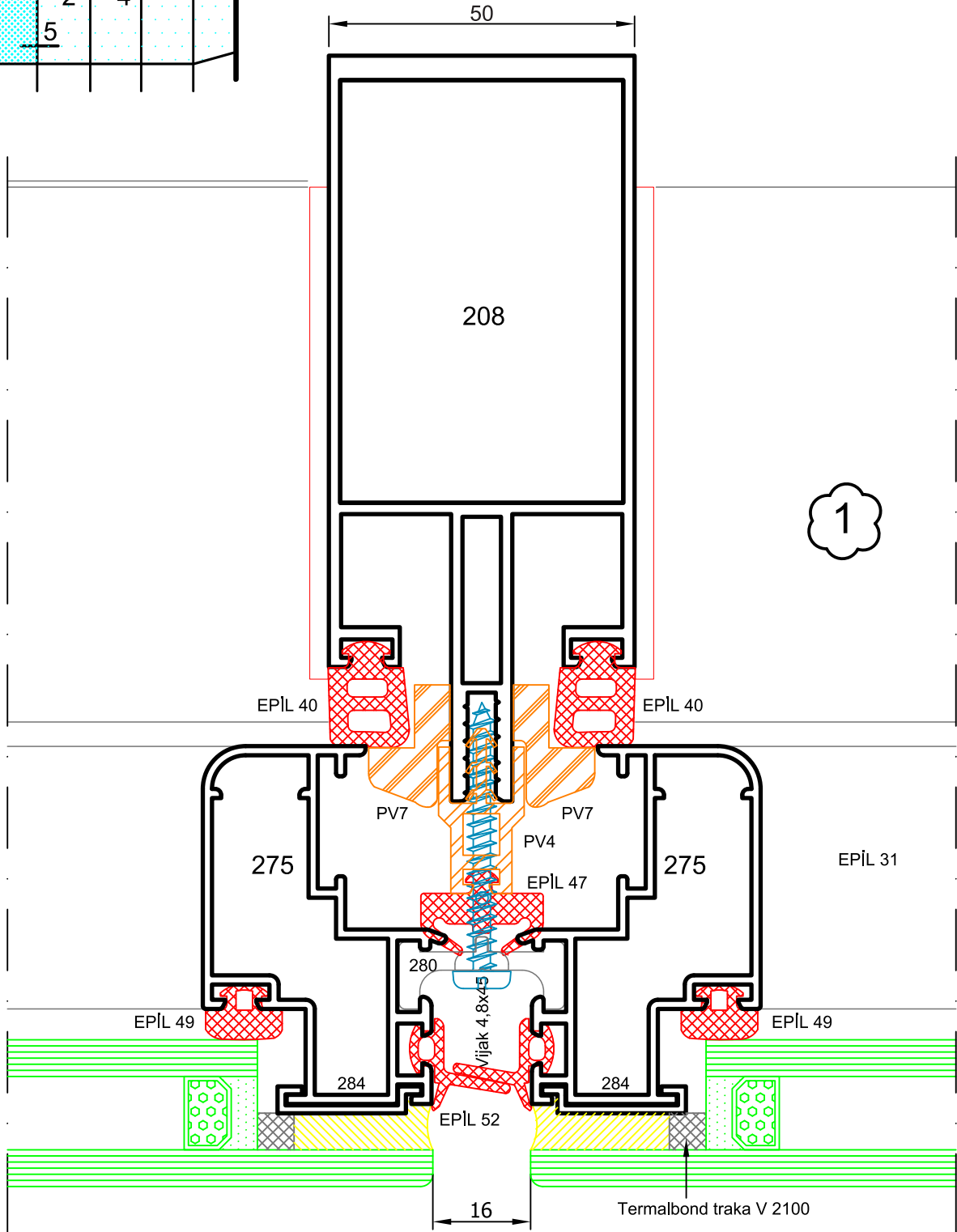
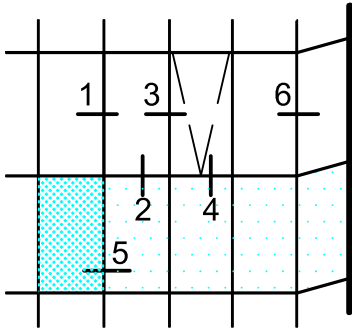

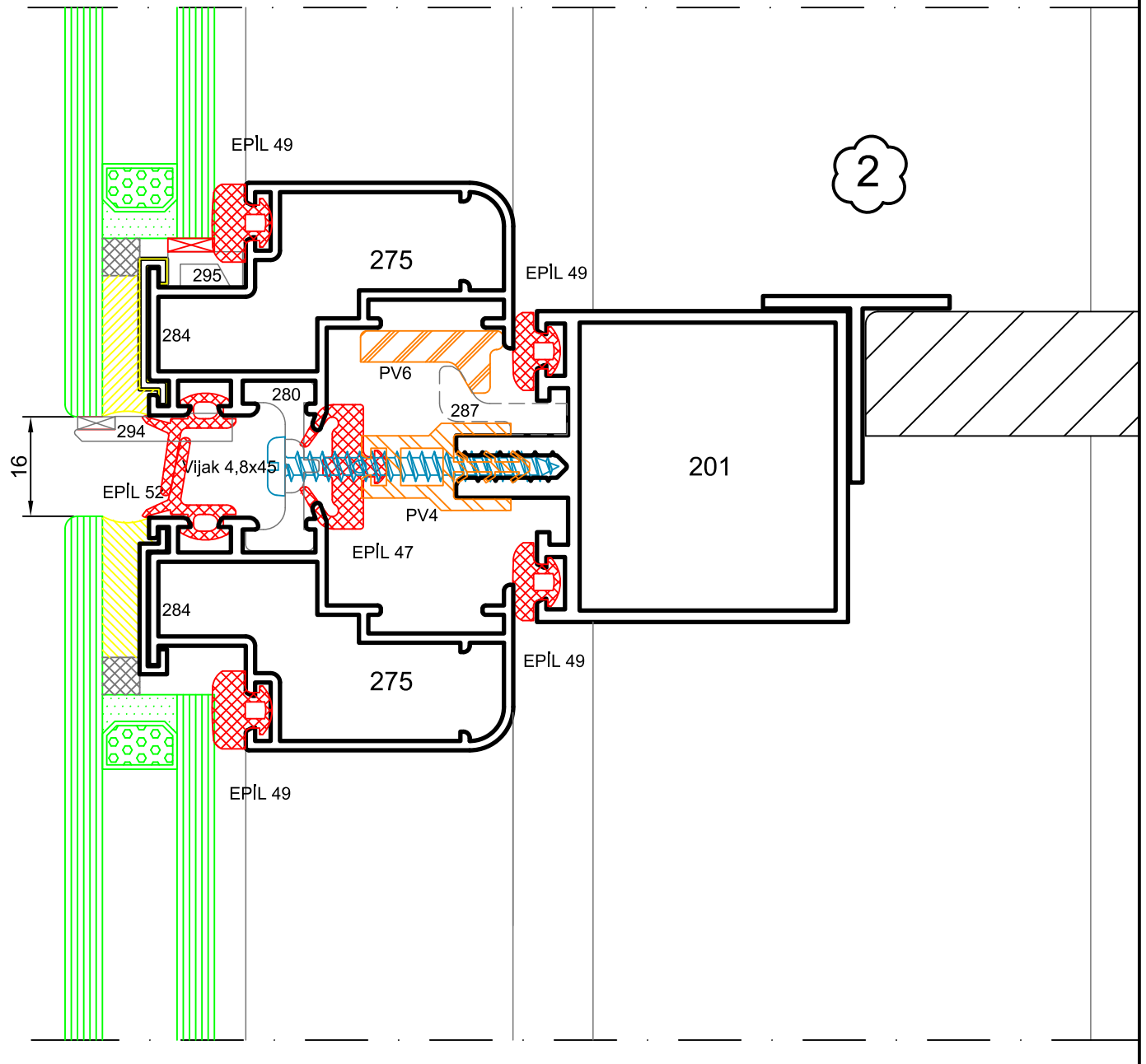
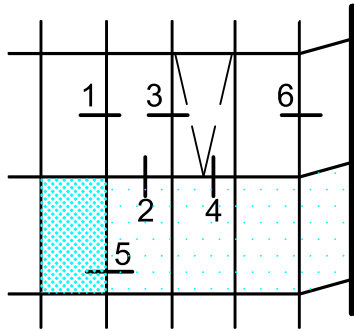

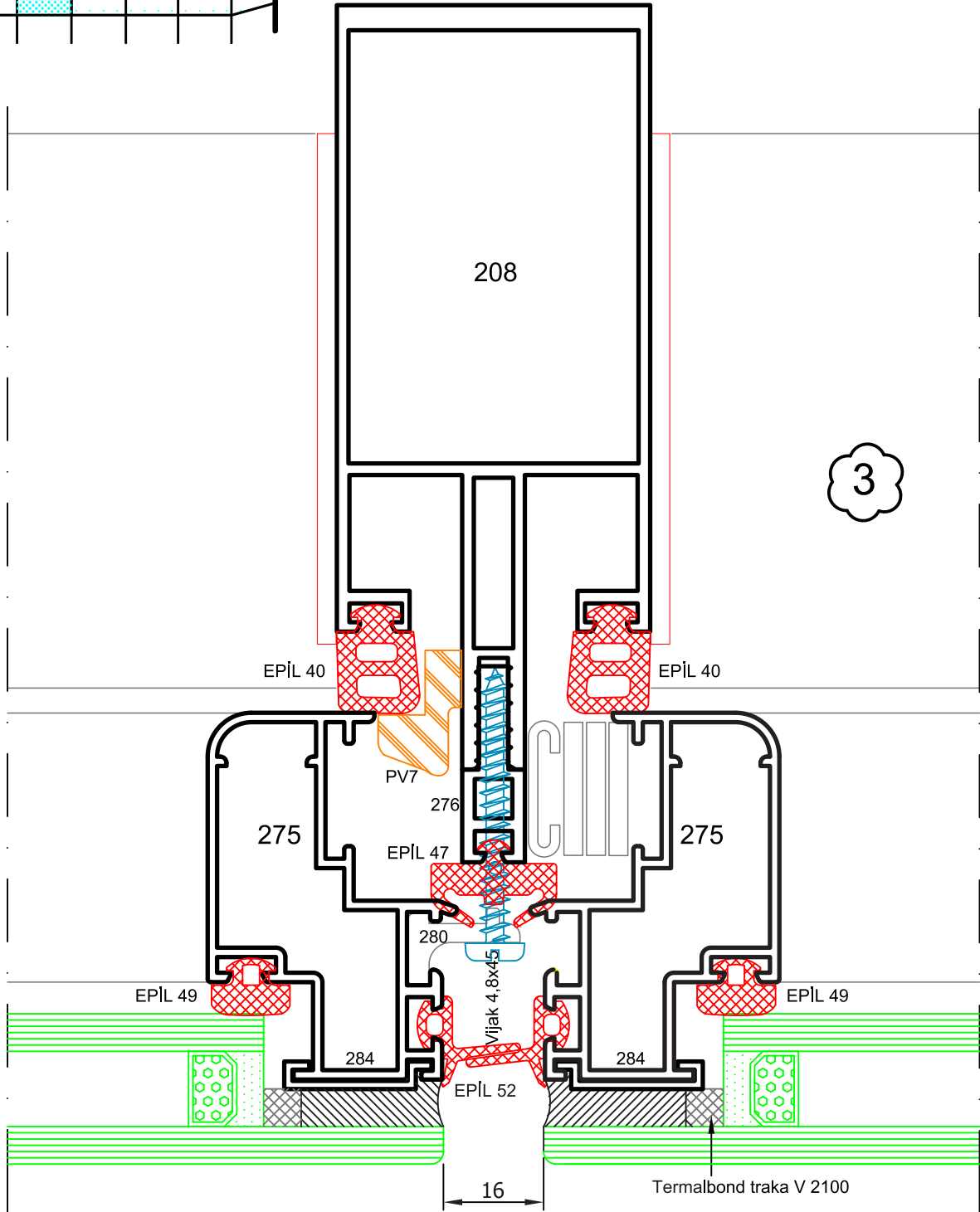
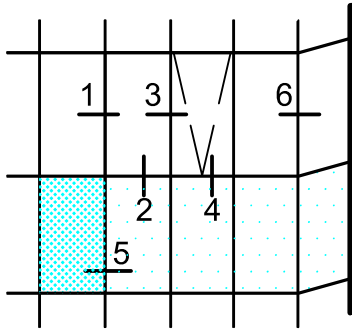

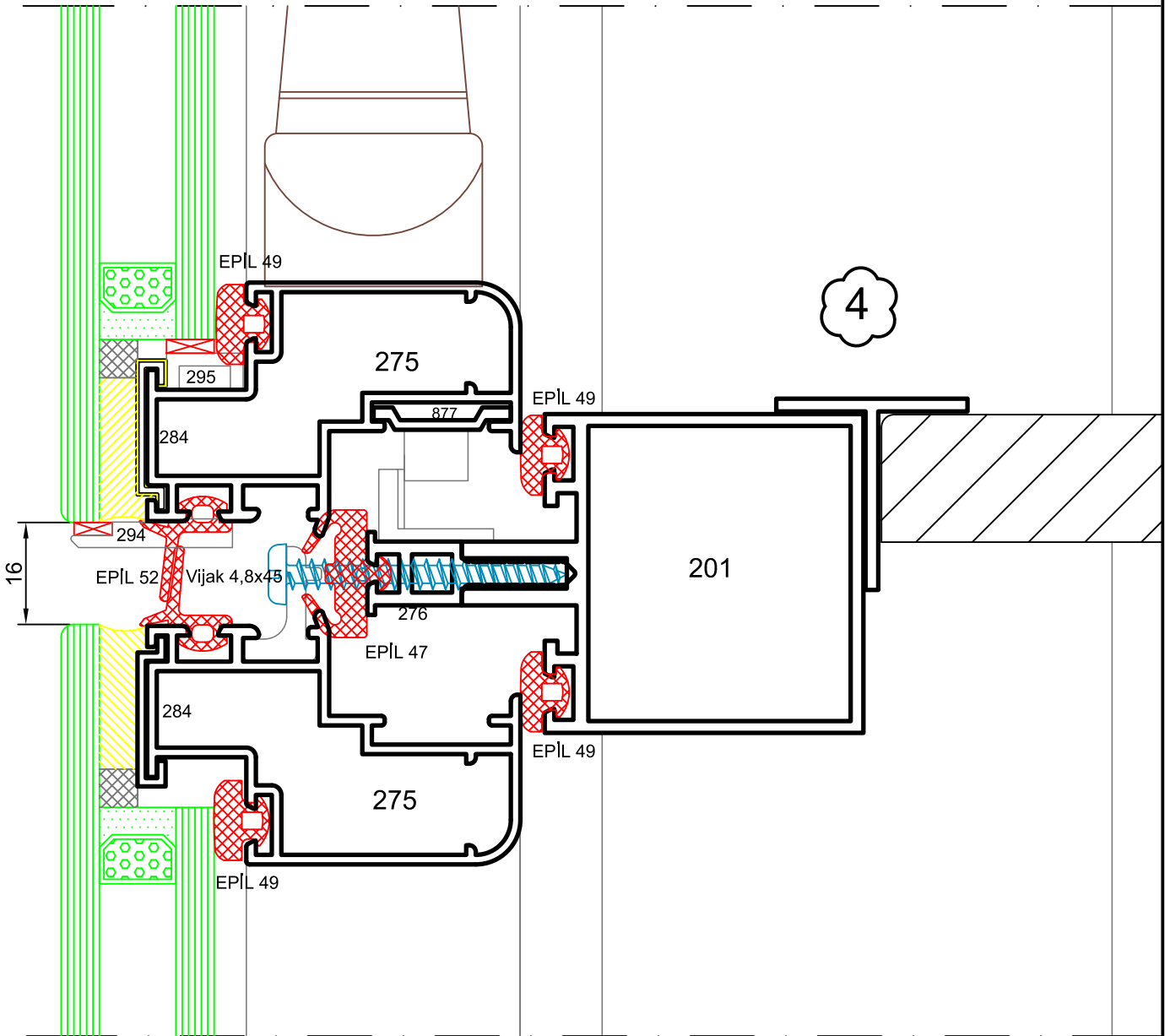
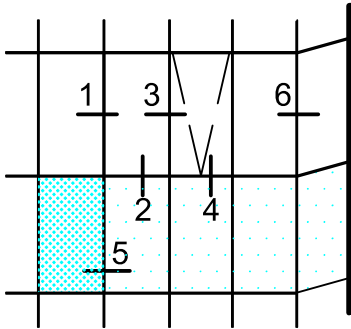

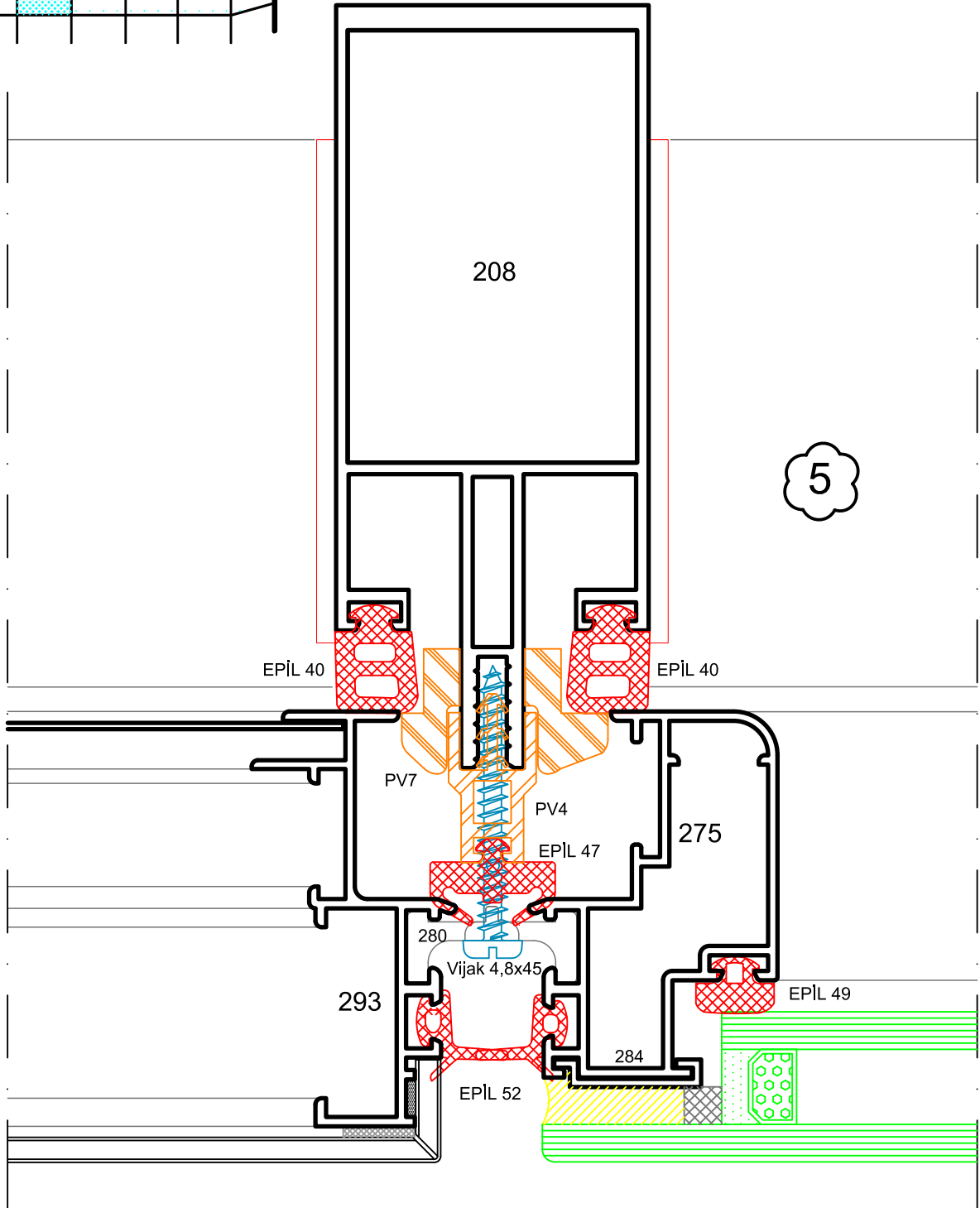
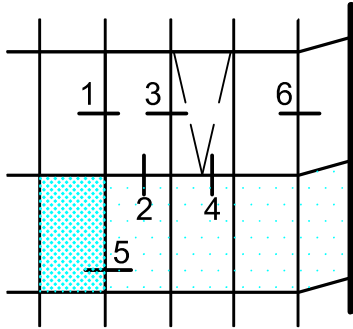

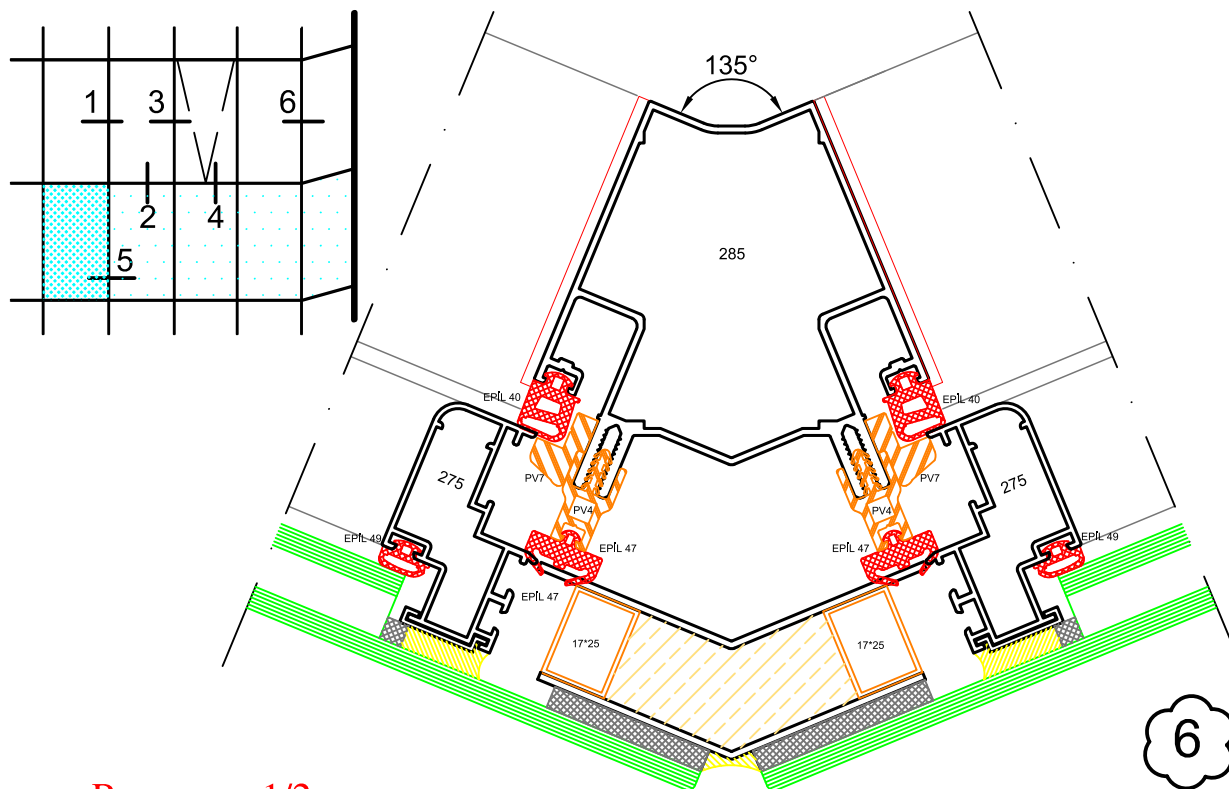

Razmera : 1/2

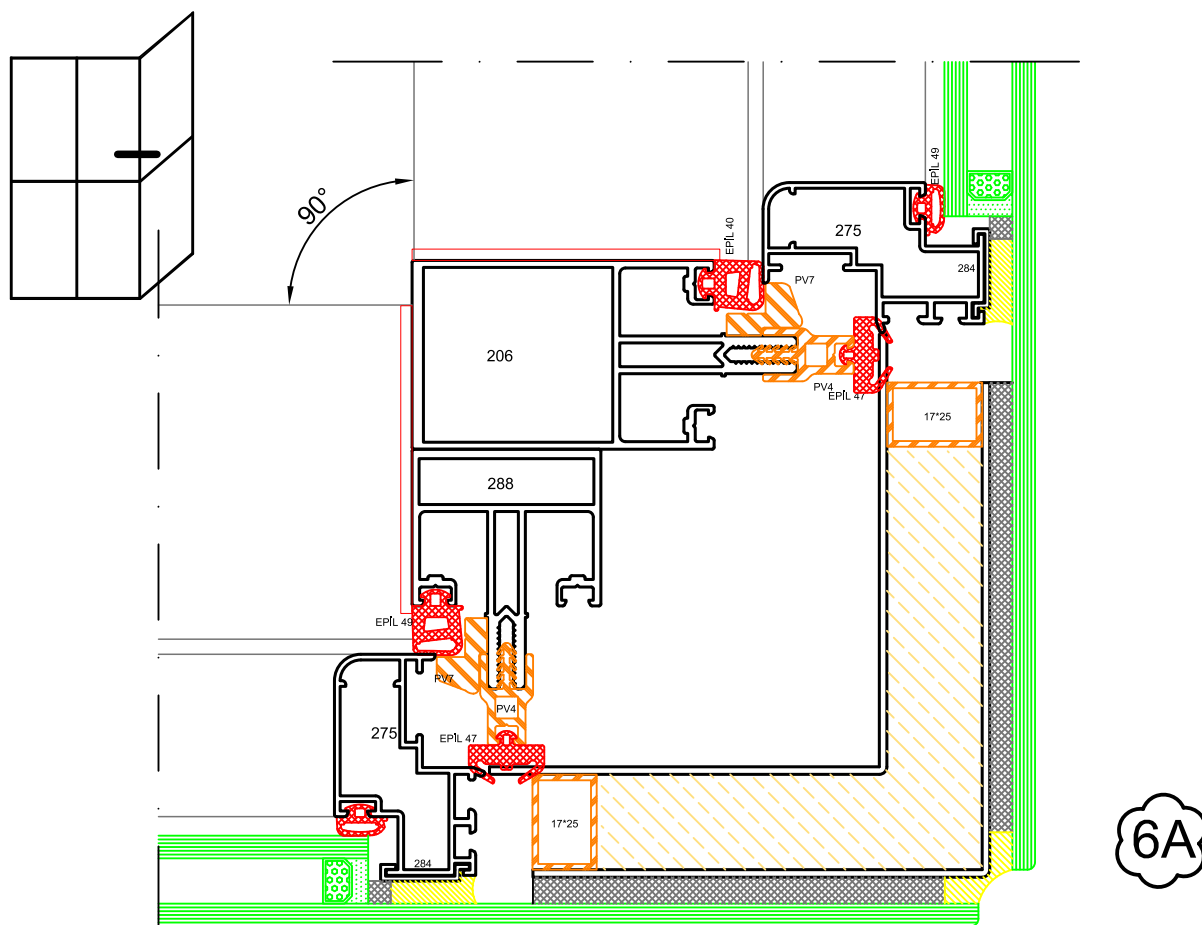

Razmera : 1/2

Proizvodne mere

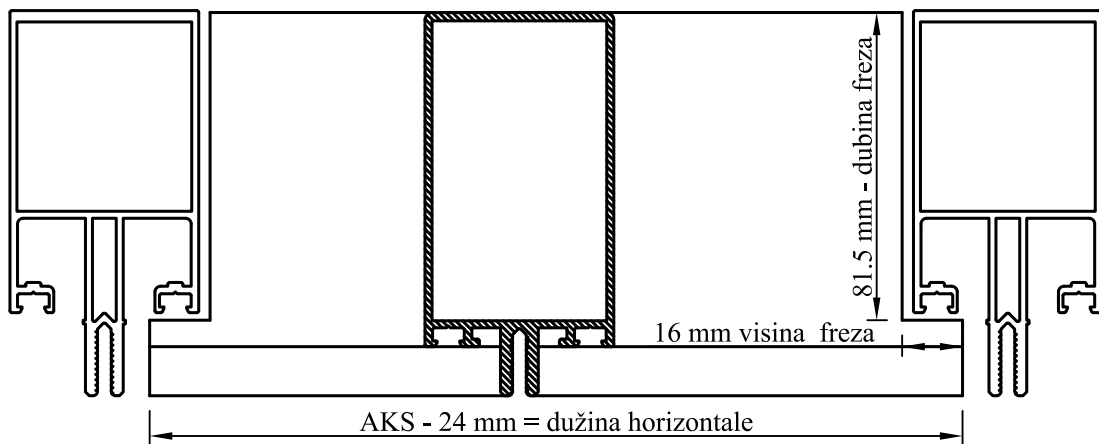
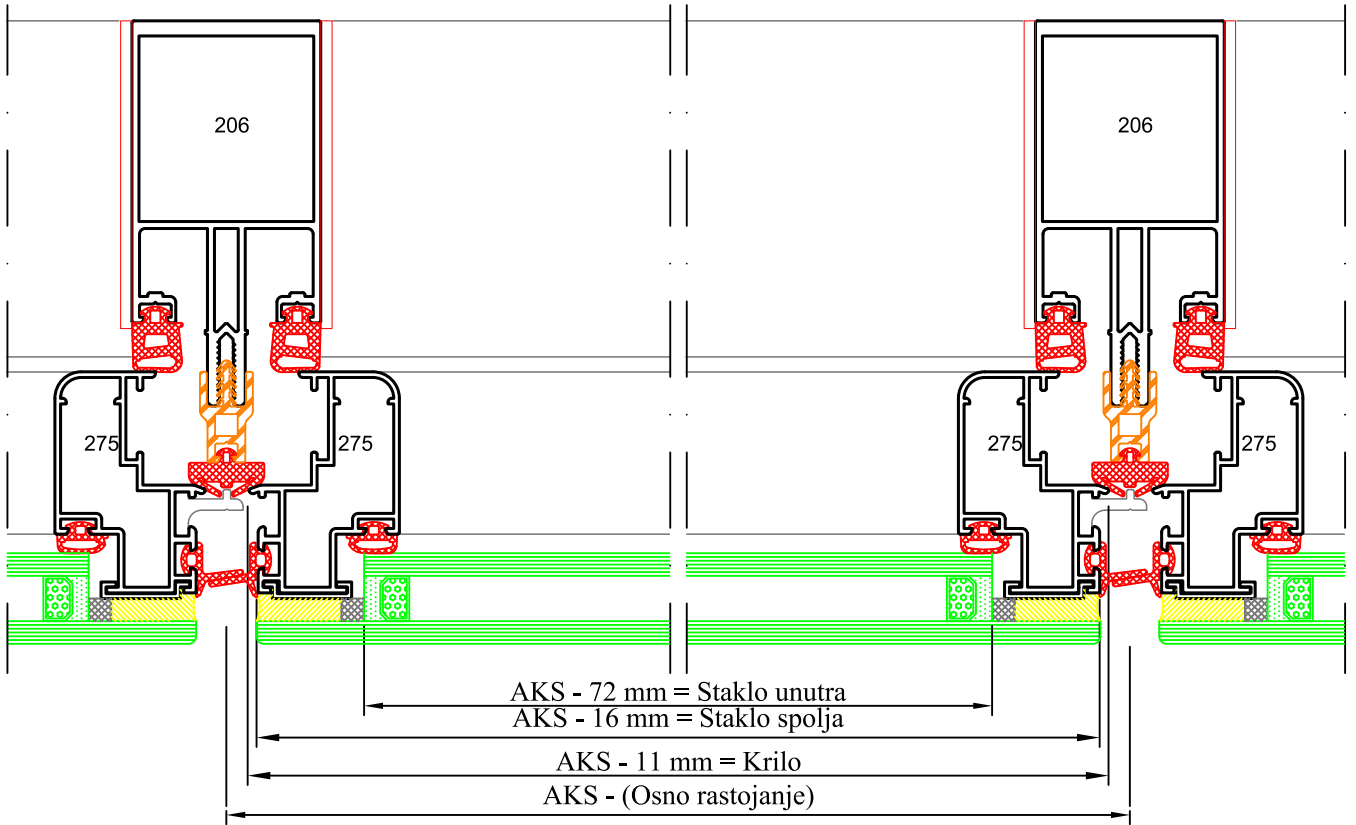



Sistem strukturalnih stakala

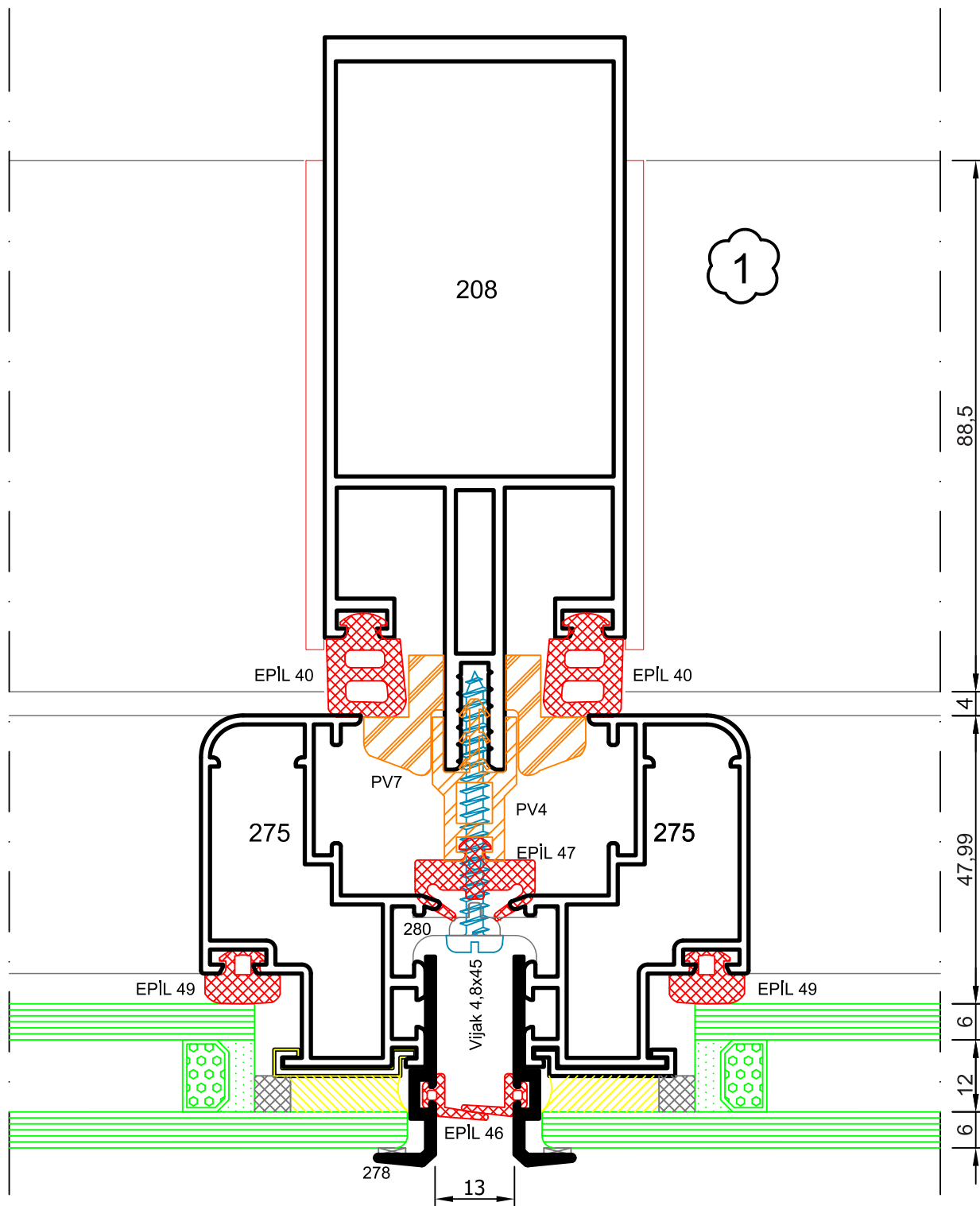
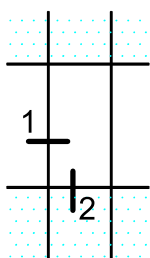

Sistem strukturalnih stakala

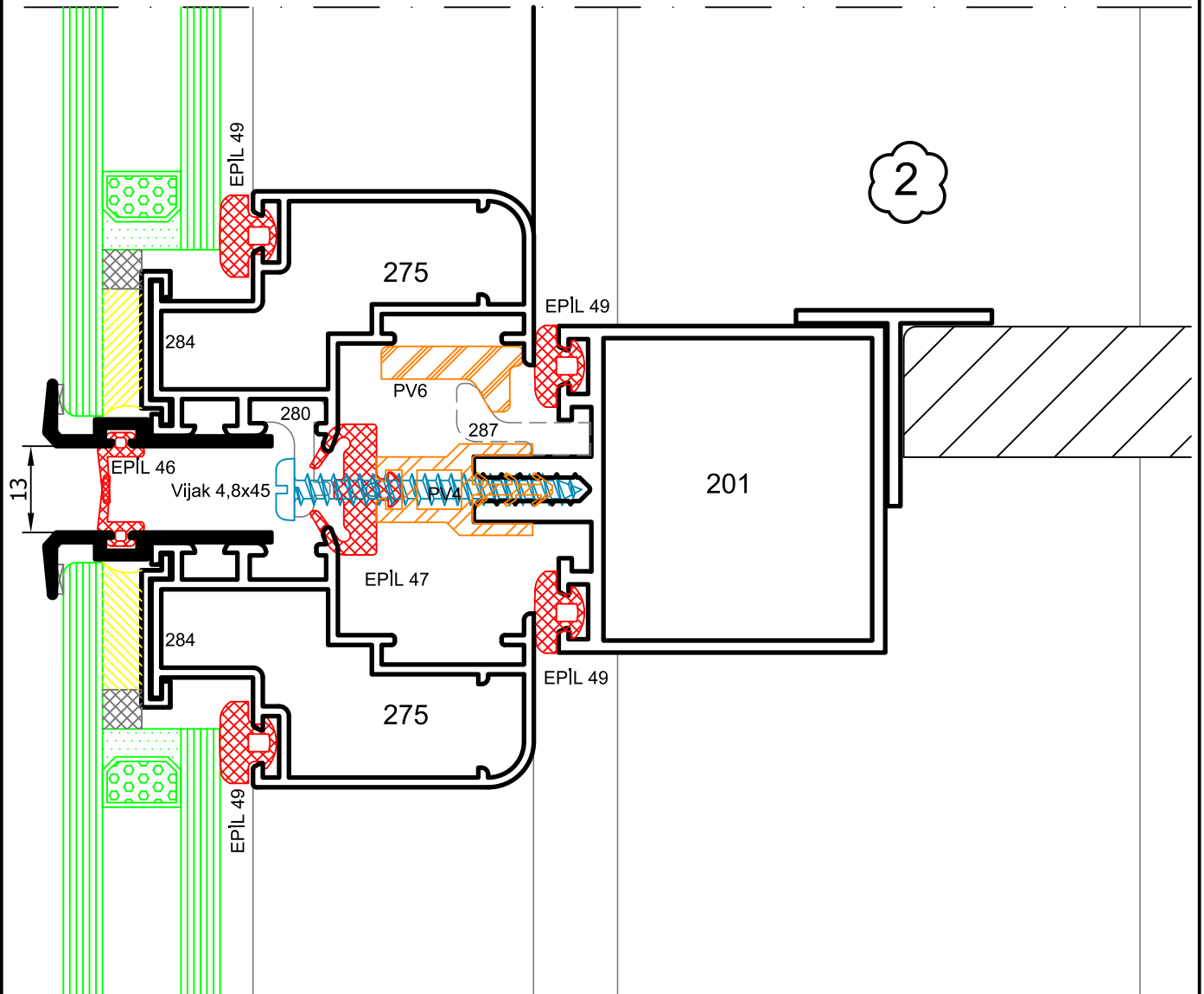
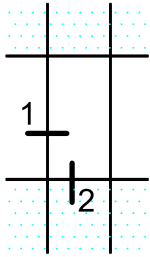

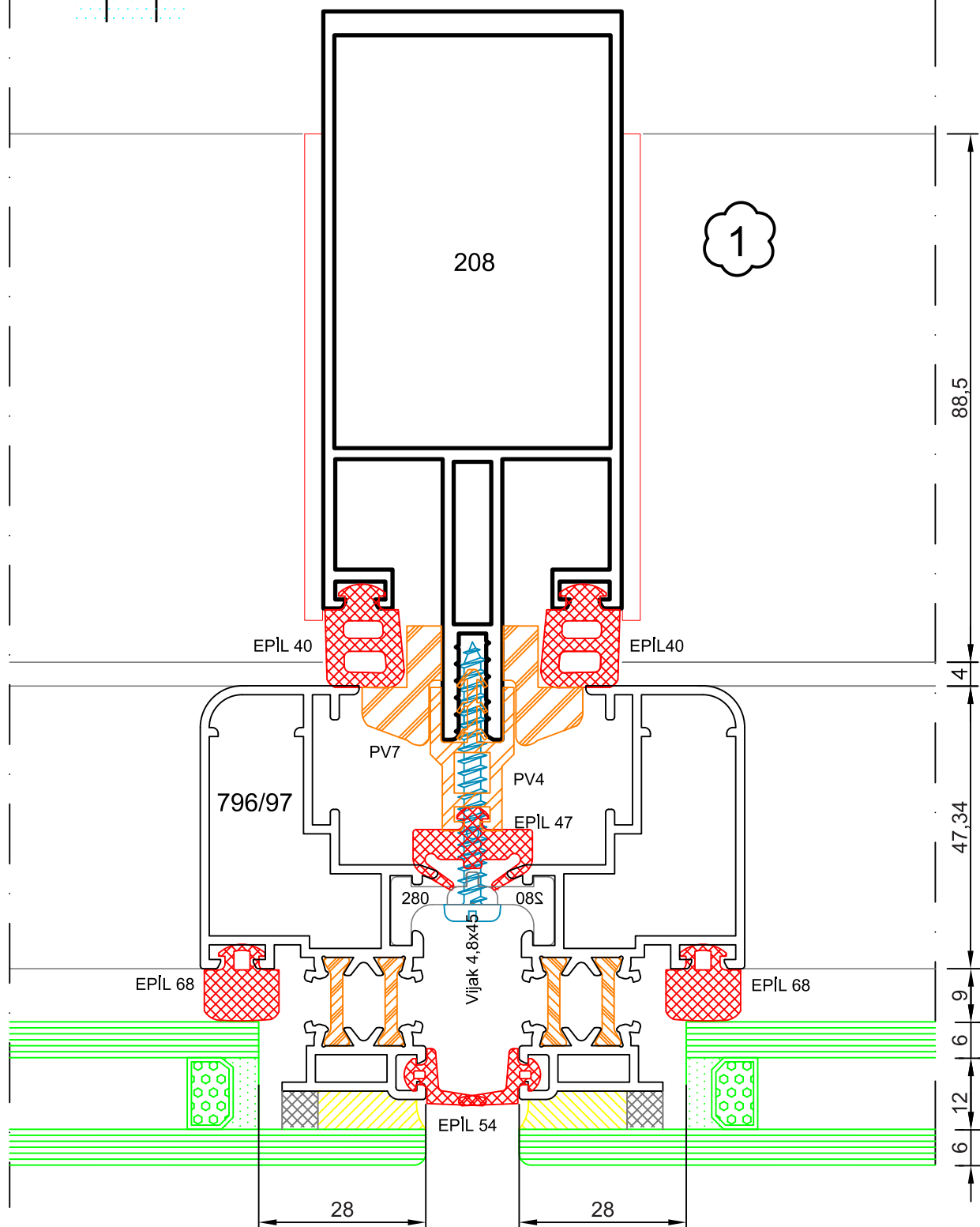
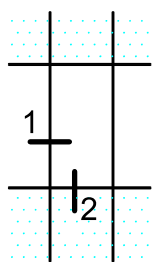

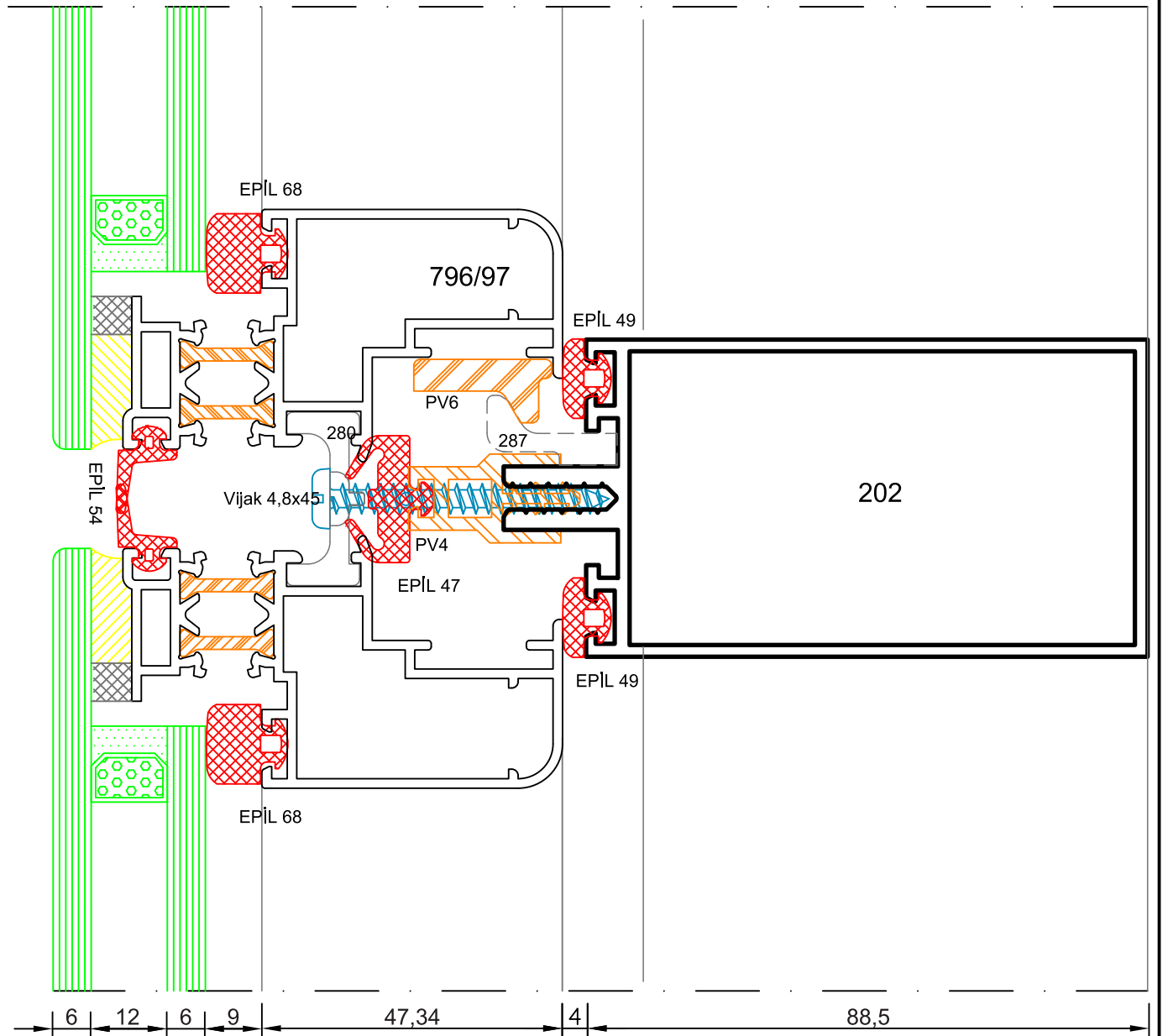
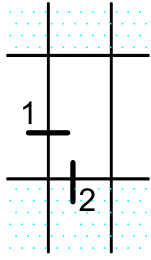

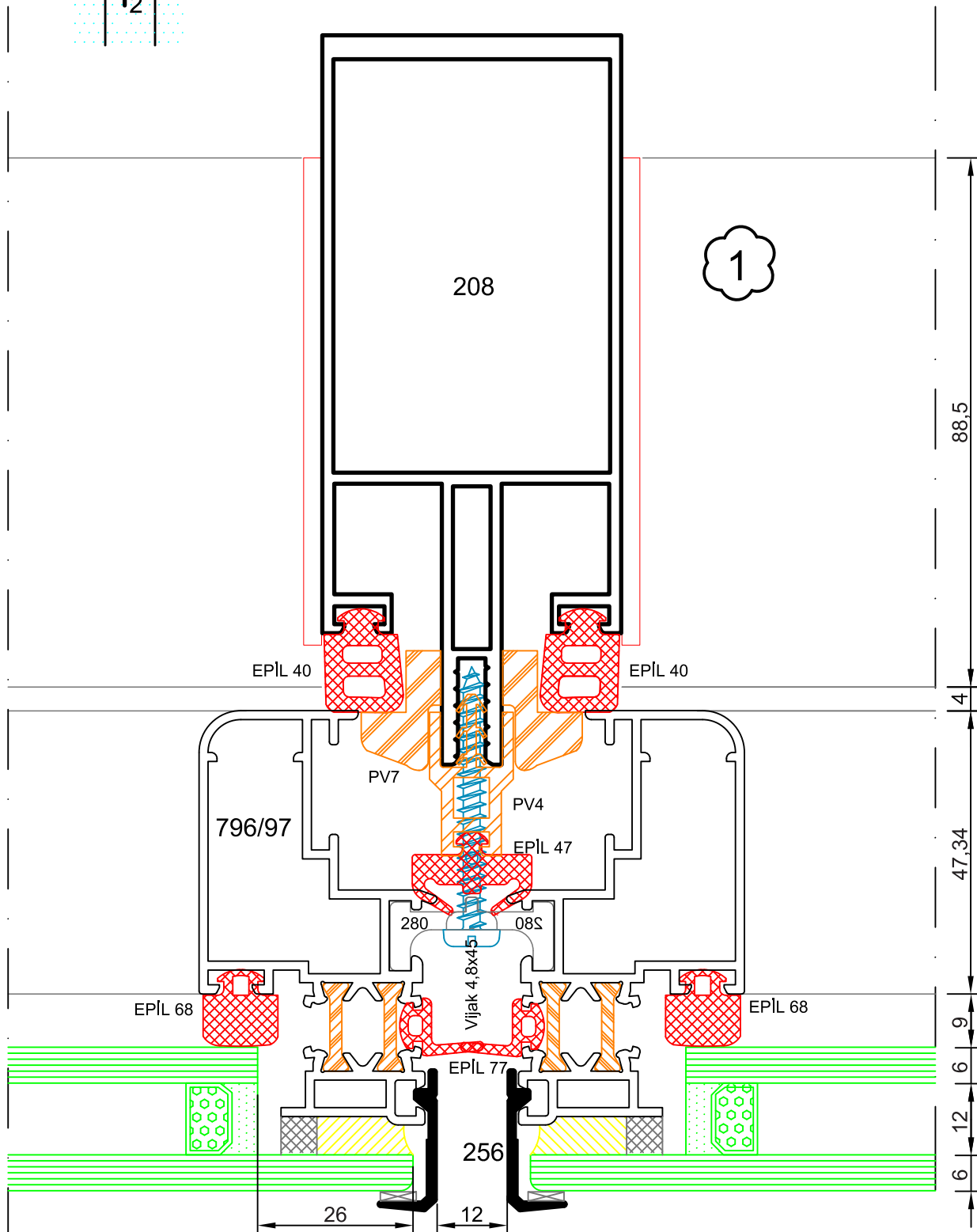
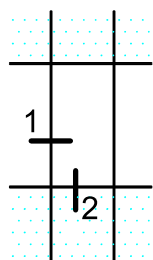



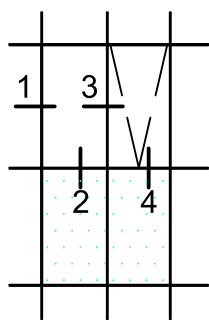

Ekonomik sistem strukturalnih stakala

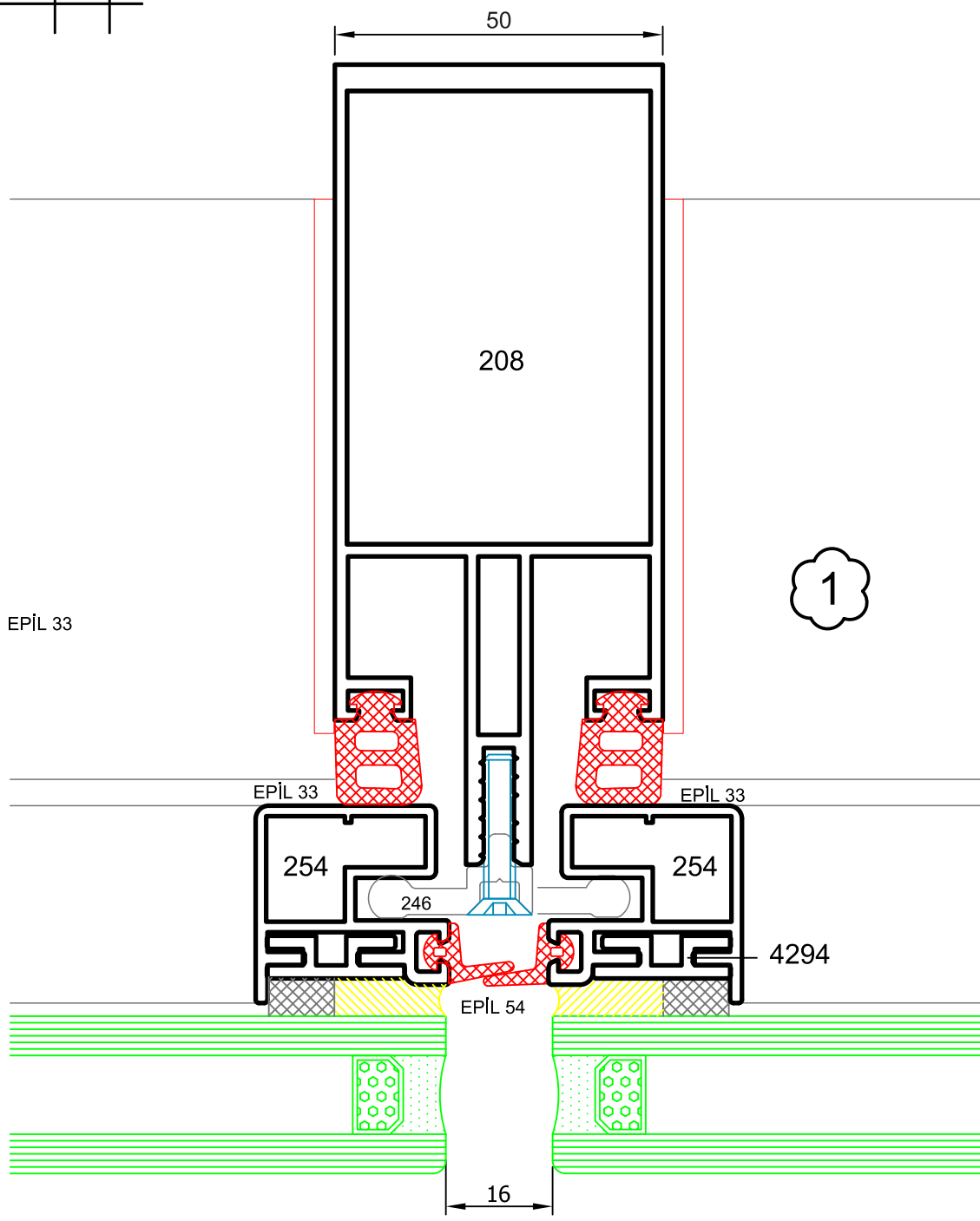

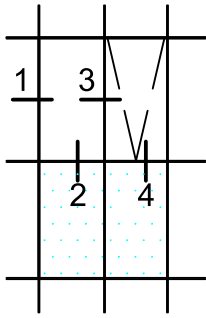

Ekonomik sistem strukturalnih stakala

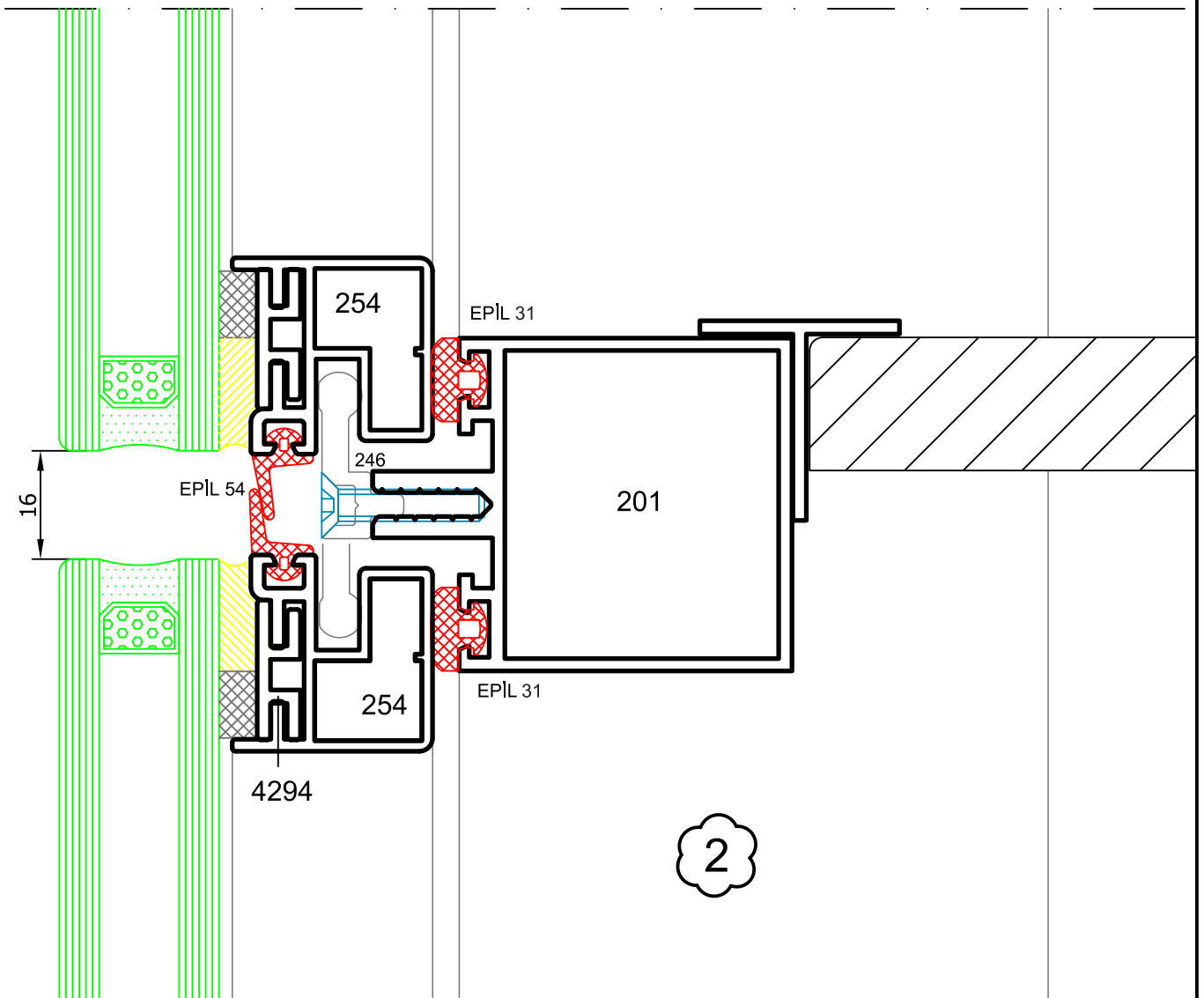



Ekonomik sistem strukturalnih stakala

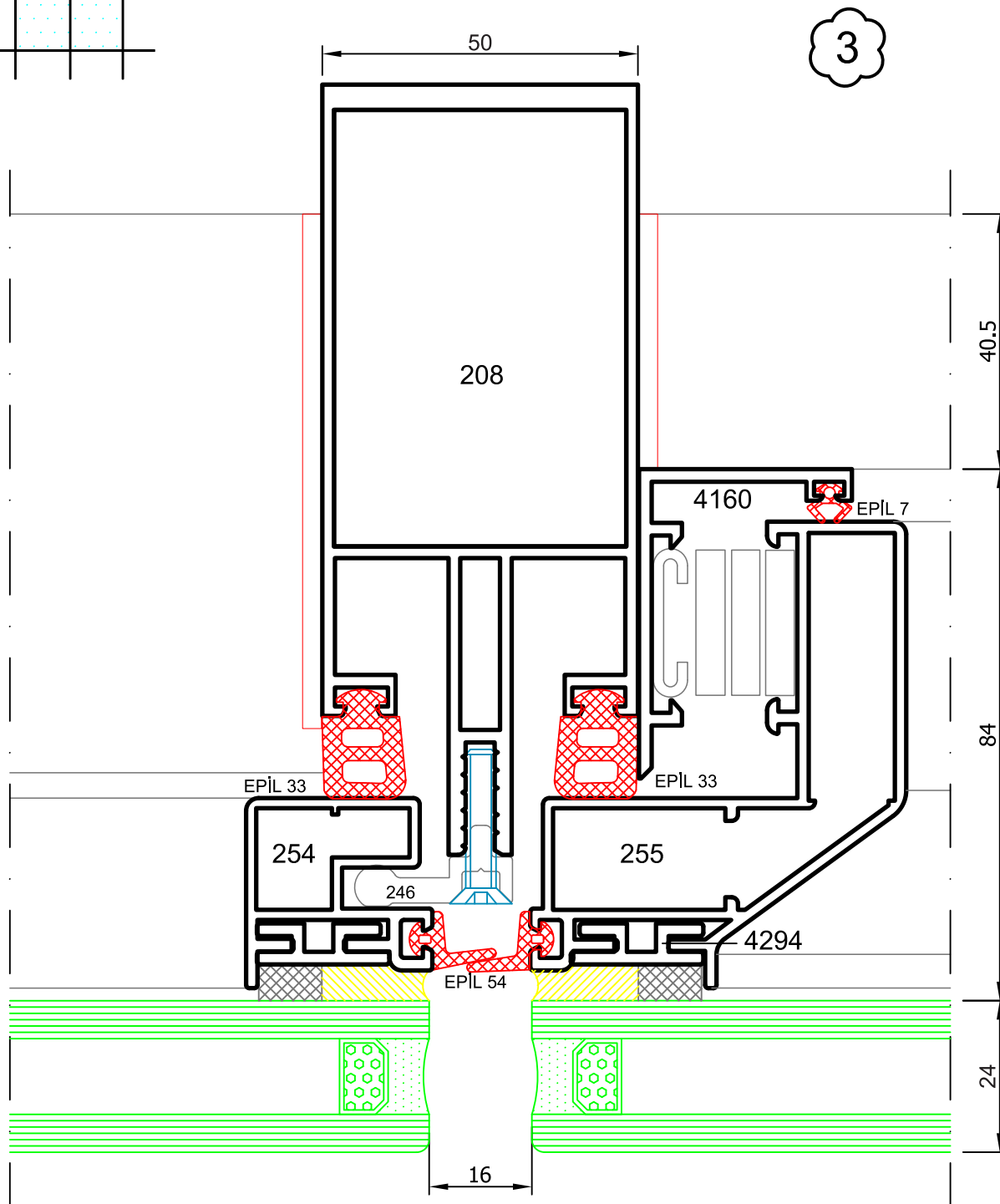
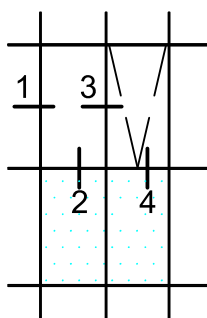

**Ekonomik sistem strukturalnih stakala**

4

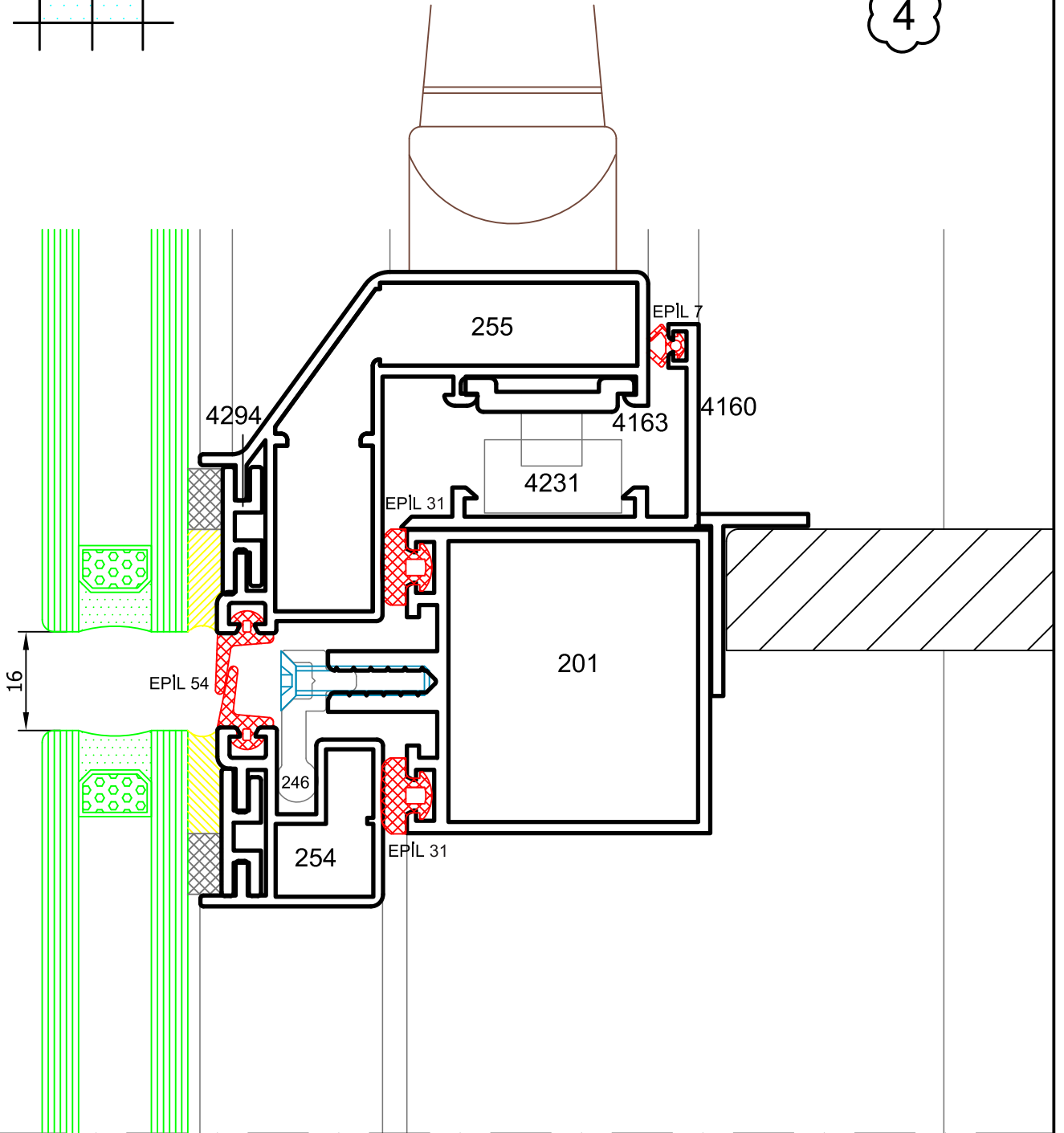
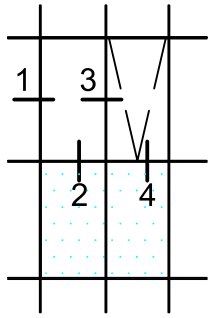

Ekonomik sistem strukturalnih stakala

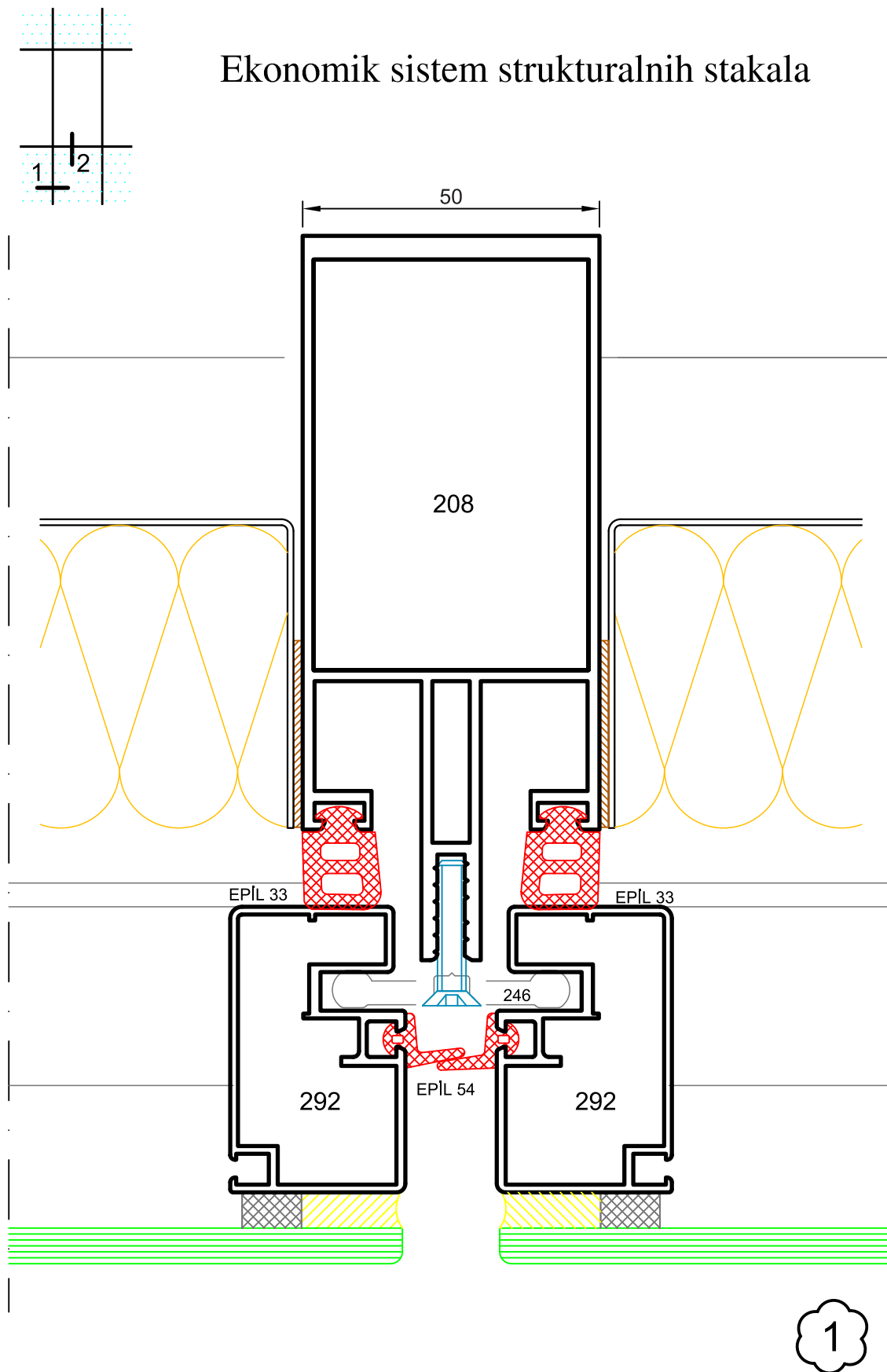

Ekonomik sistem strukturalnih stakala

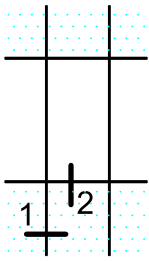

2

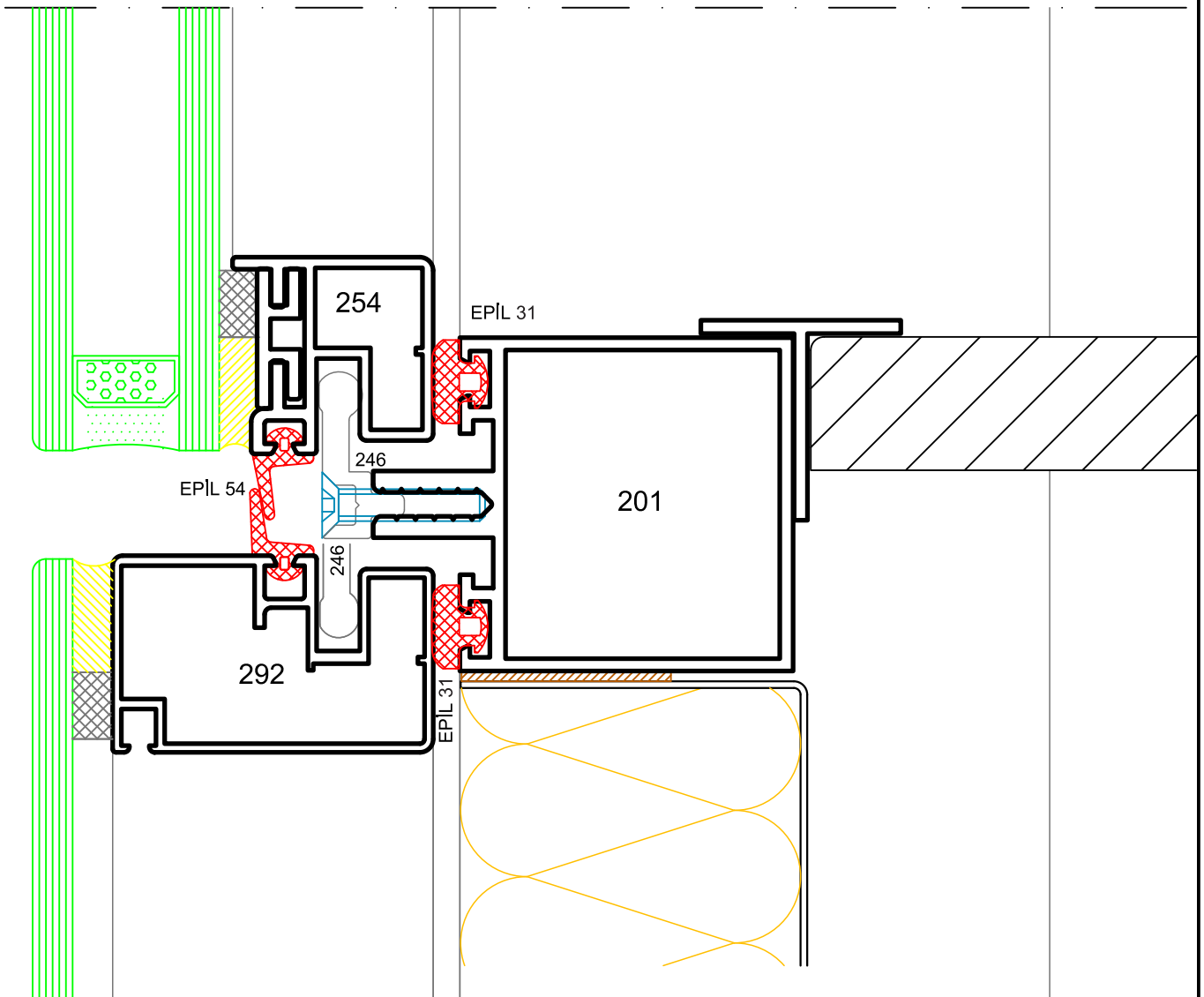



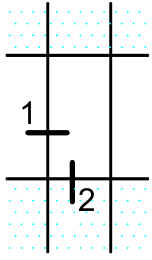

Ekonomik sistem silikoniranih stakala

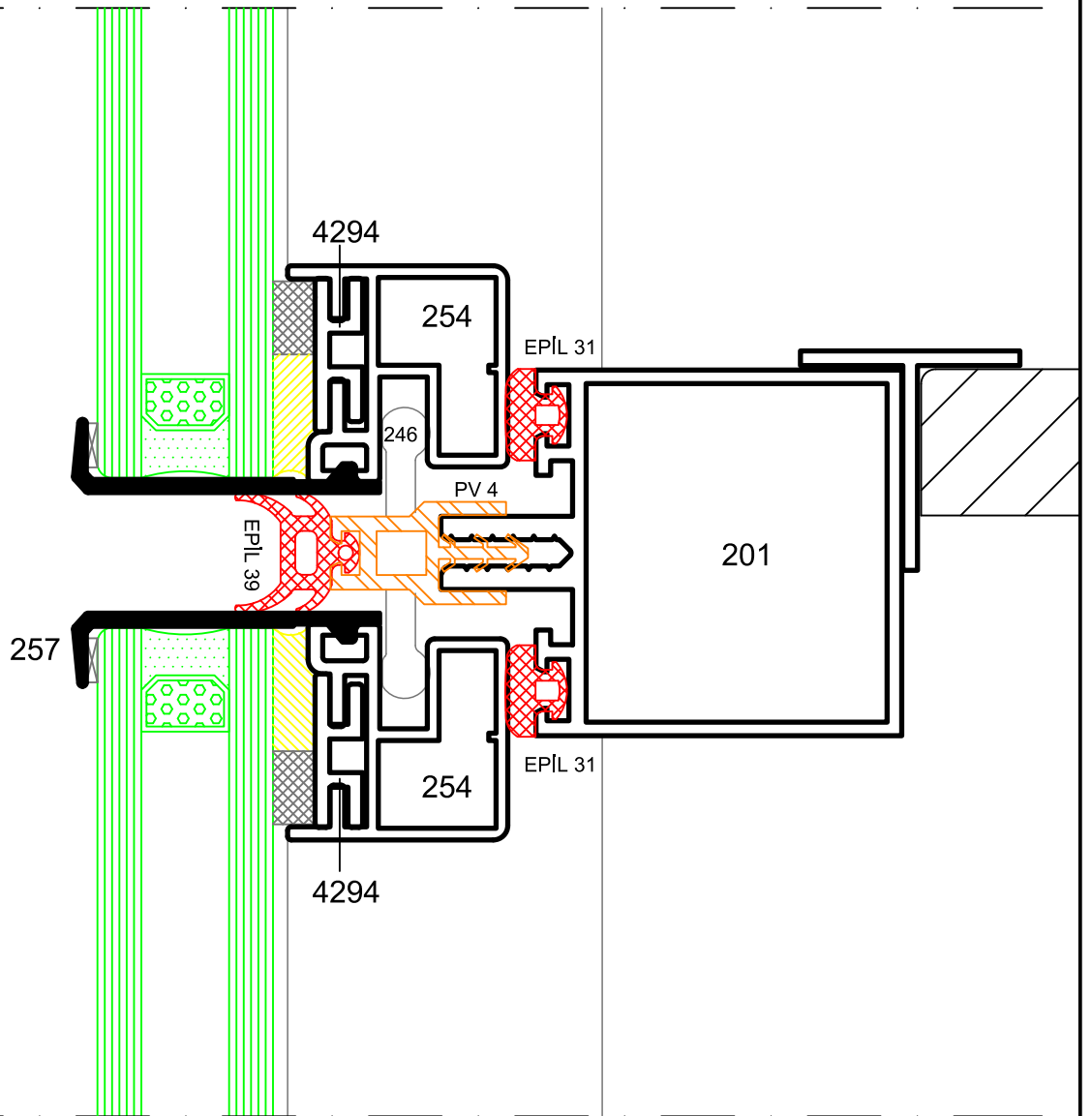

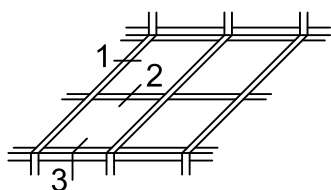

1

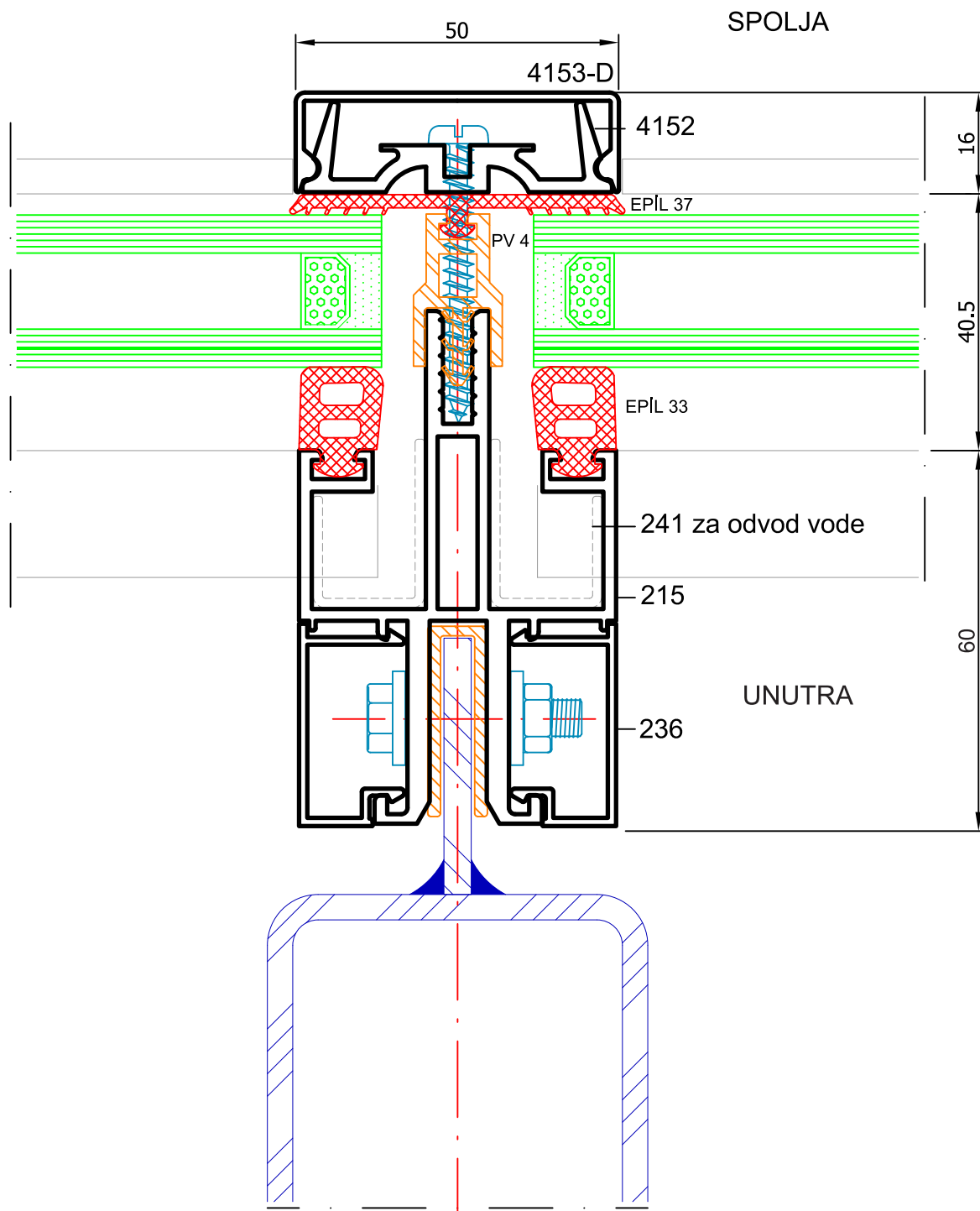

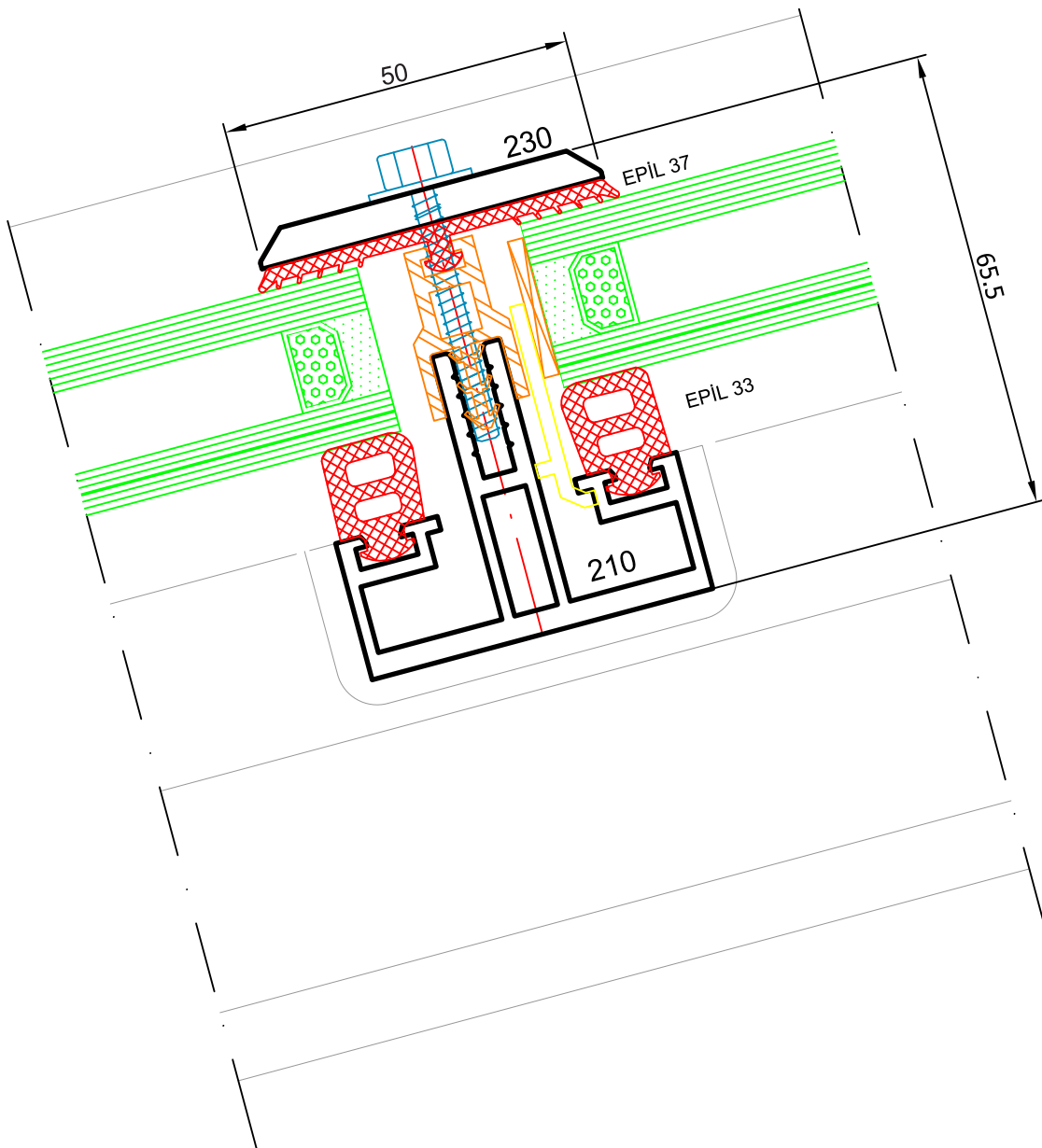
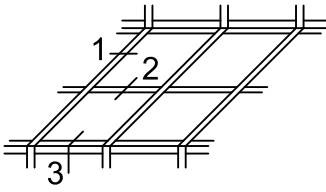



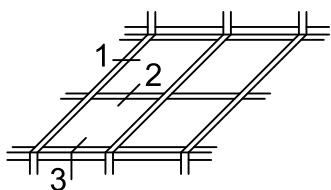

3

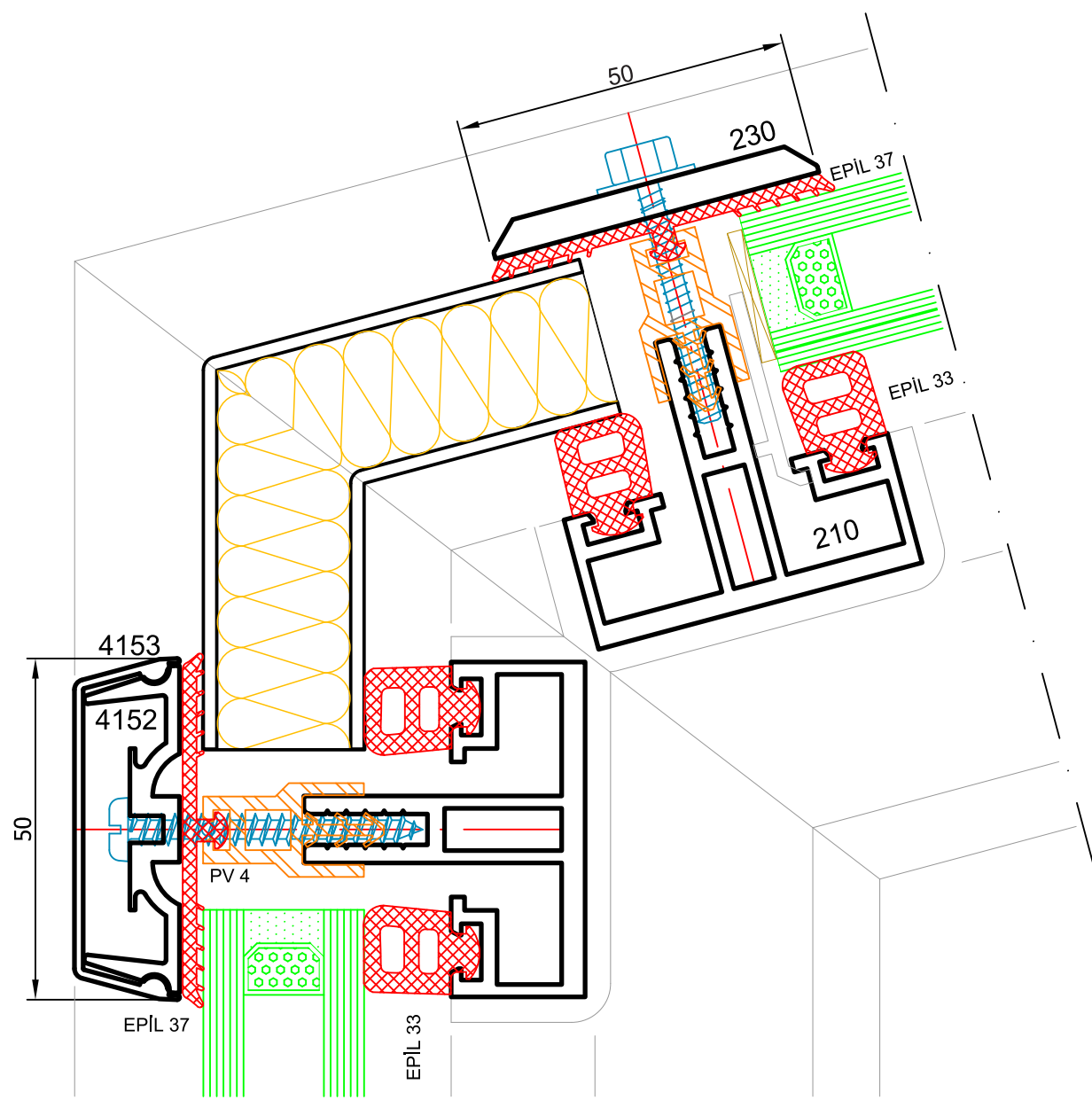

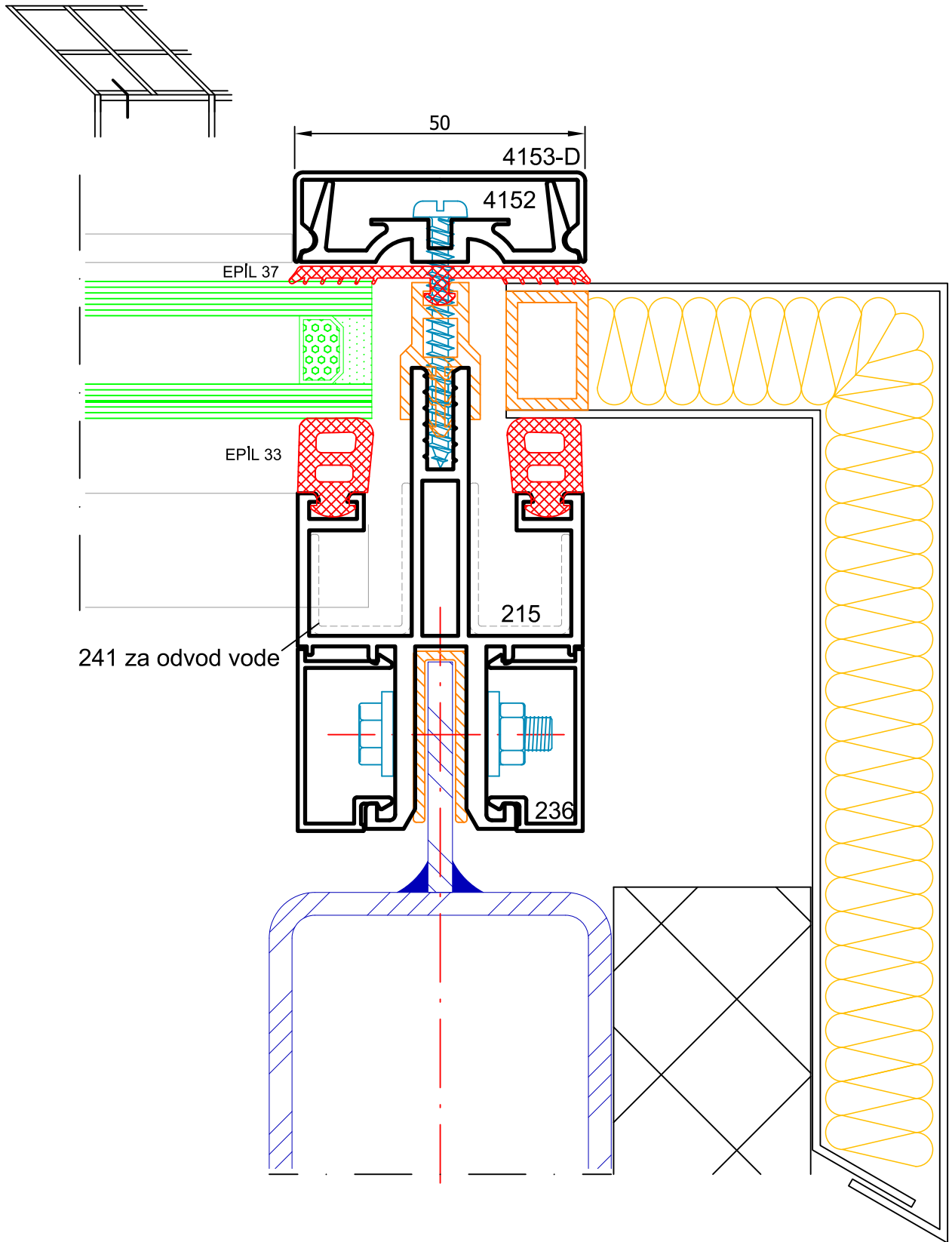

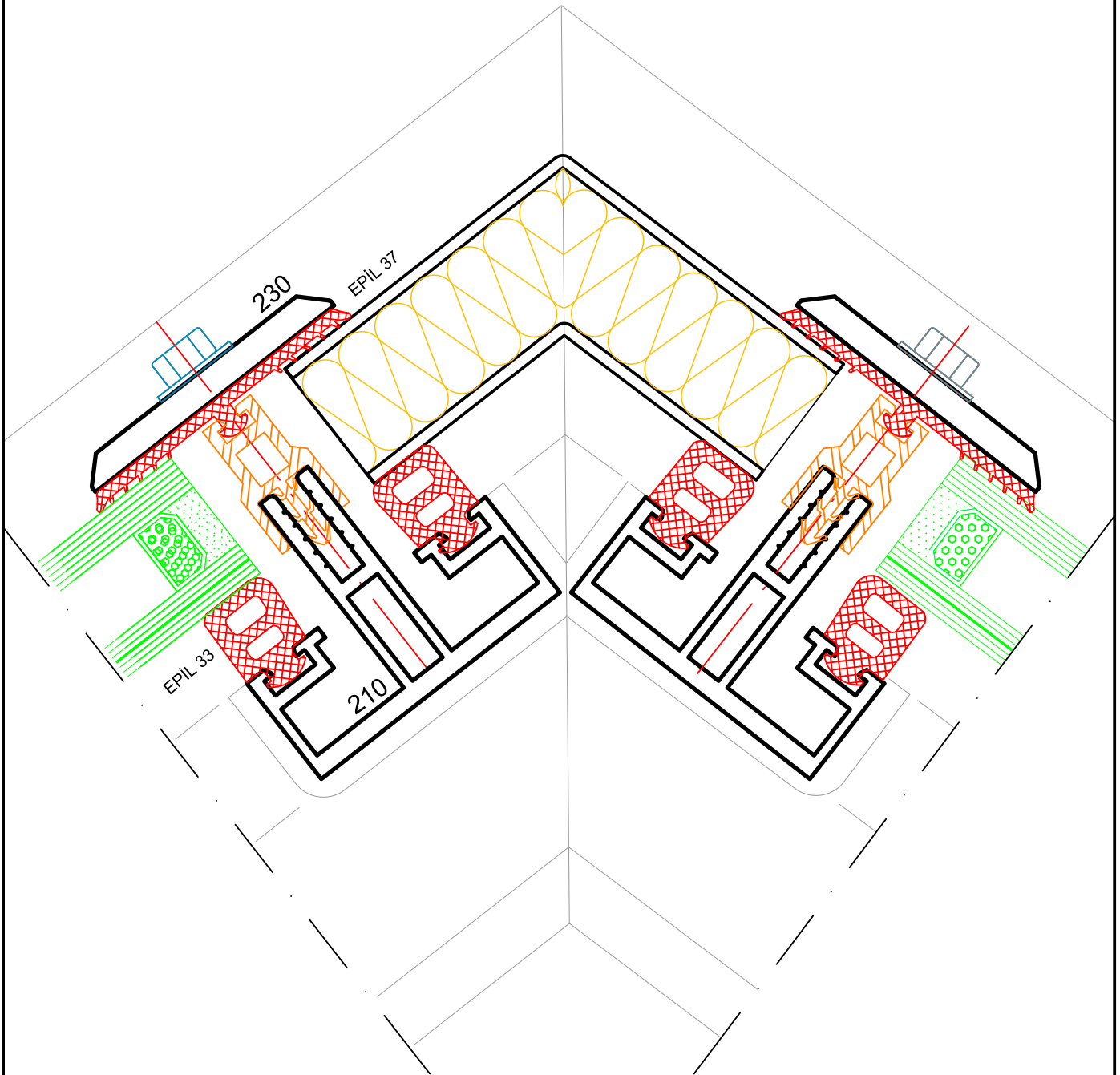
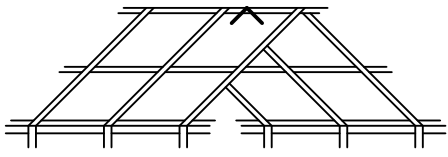

*Sistem nalivenih stakala*

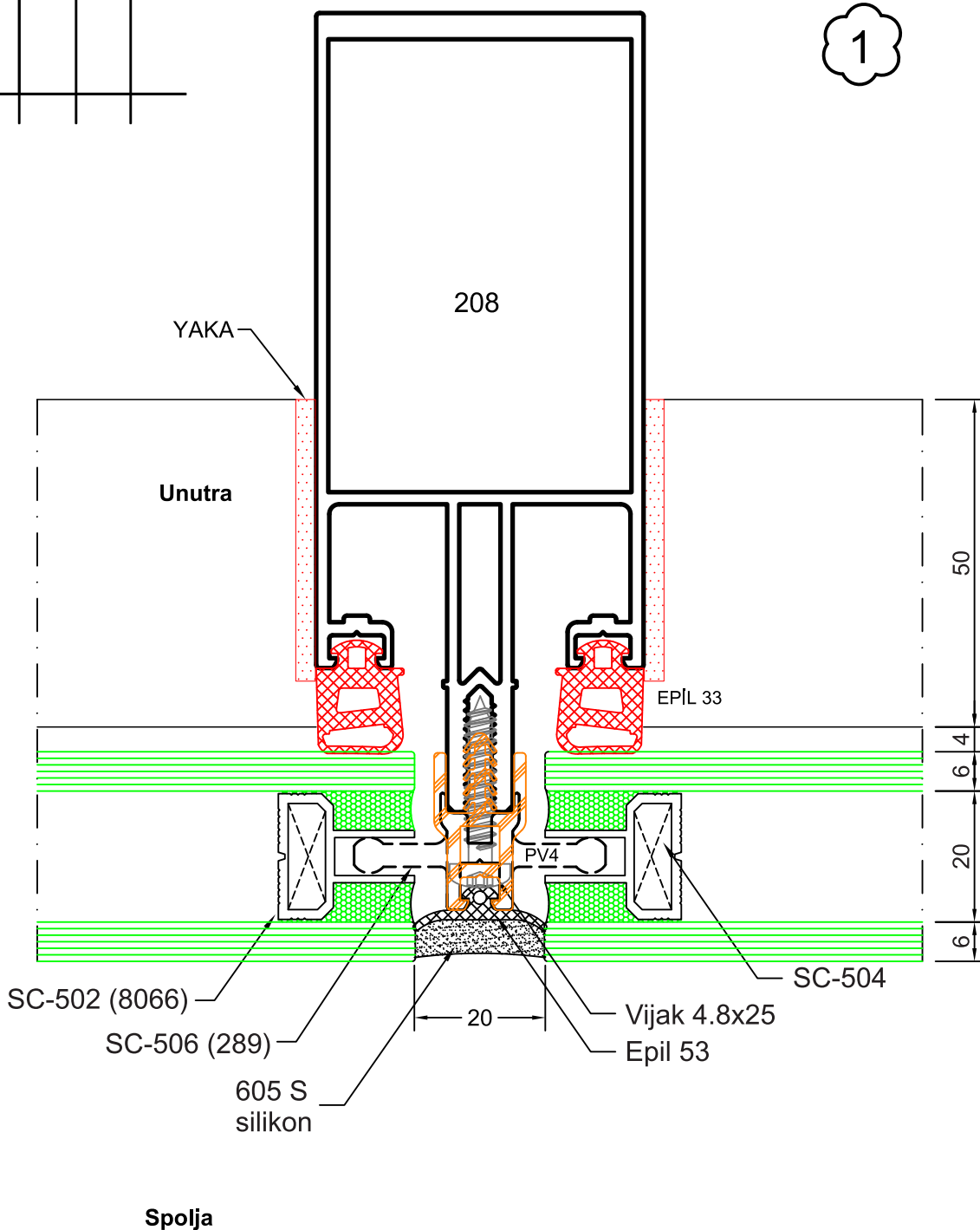

**NAPOMENA:**

- *Koristiti na zgradama maksimalne visine do 10m.*
- *Silikonirana stakla veća od 1 m osigurati pokrivnim kapama.*

Sistem nalivenih stakala

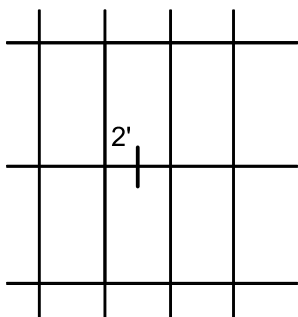

2

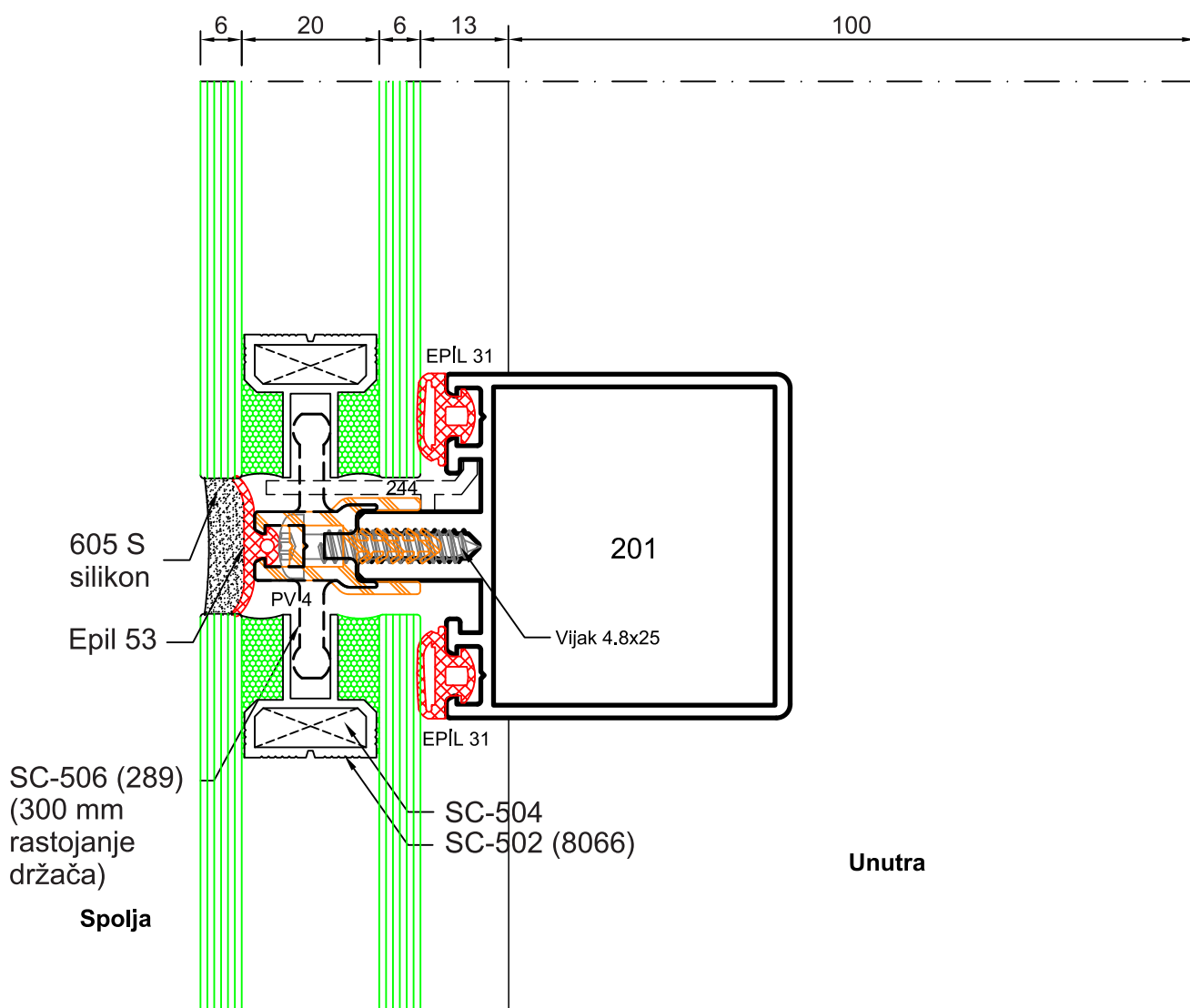

**NAPOMENA:**

- Koristiti na zgradama maksimalne visine do 10m.
- Silikonirana stakla veća od 1 m osigurati pokrivnim kapama.

**Detalj ankerisanja i izrade dilatacionog spoja**

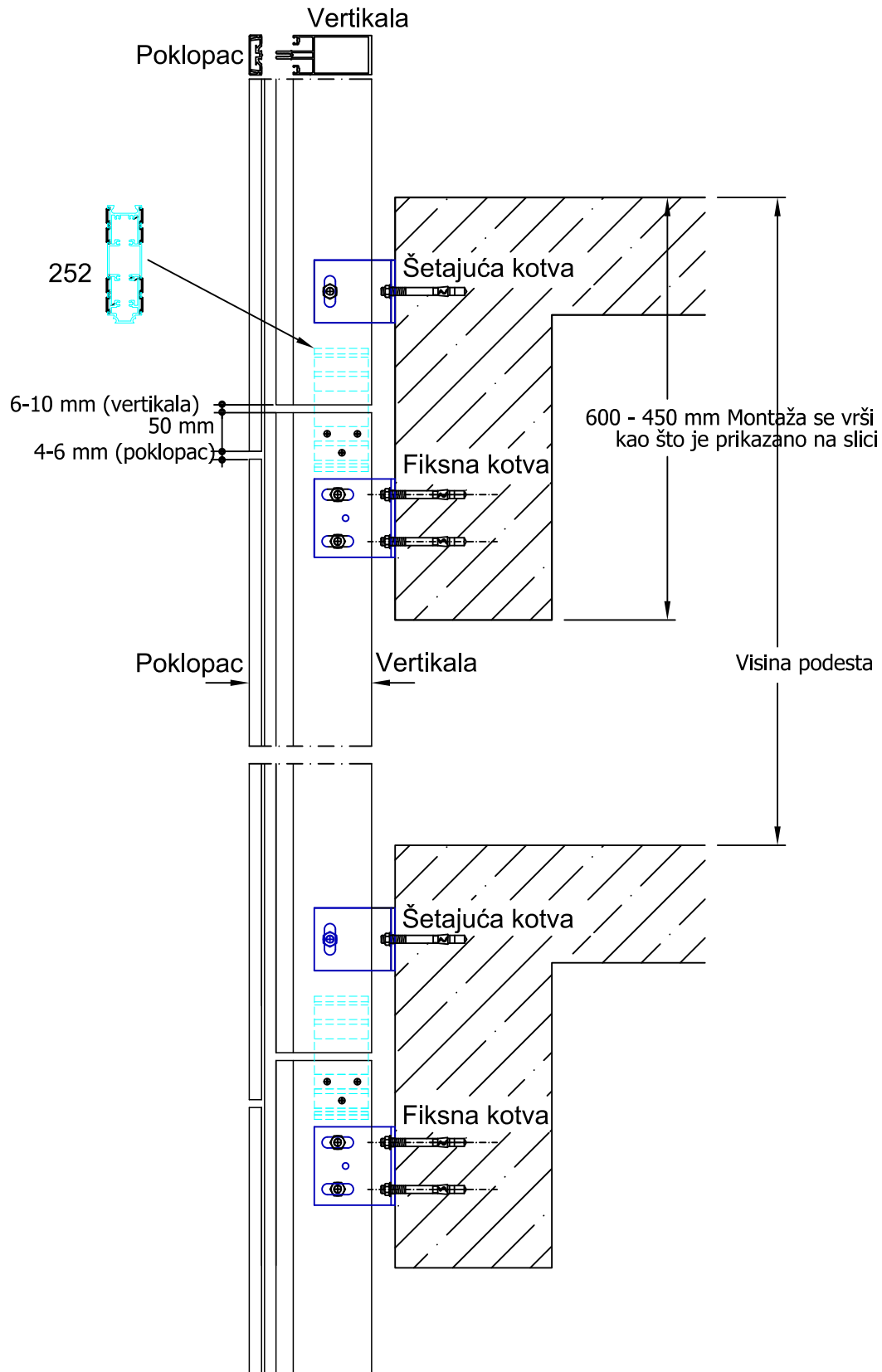

### Detalj dilatacionog profila

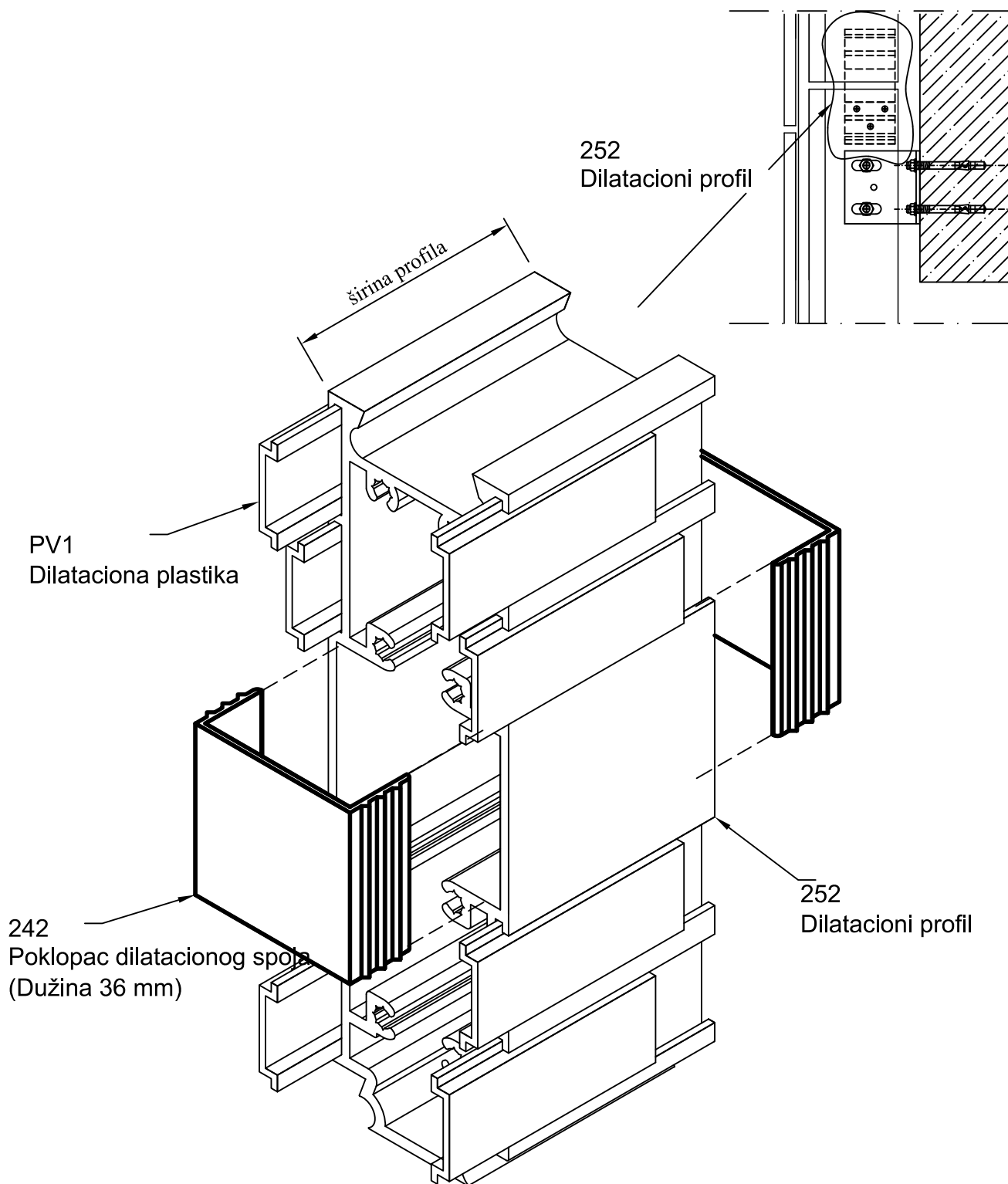

**Detalj dilatacije**

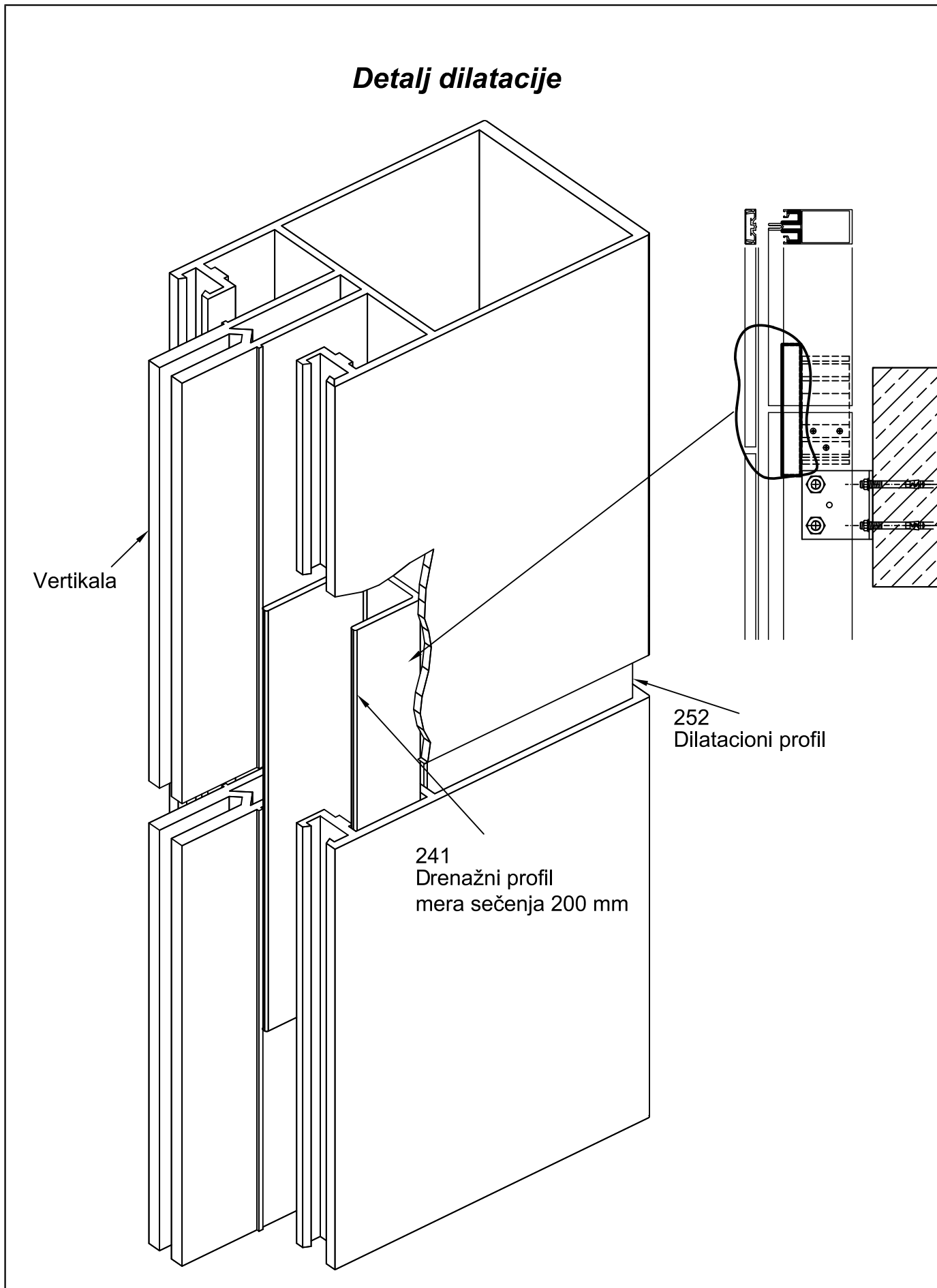



**Veza horizontale**

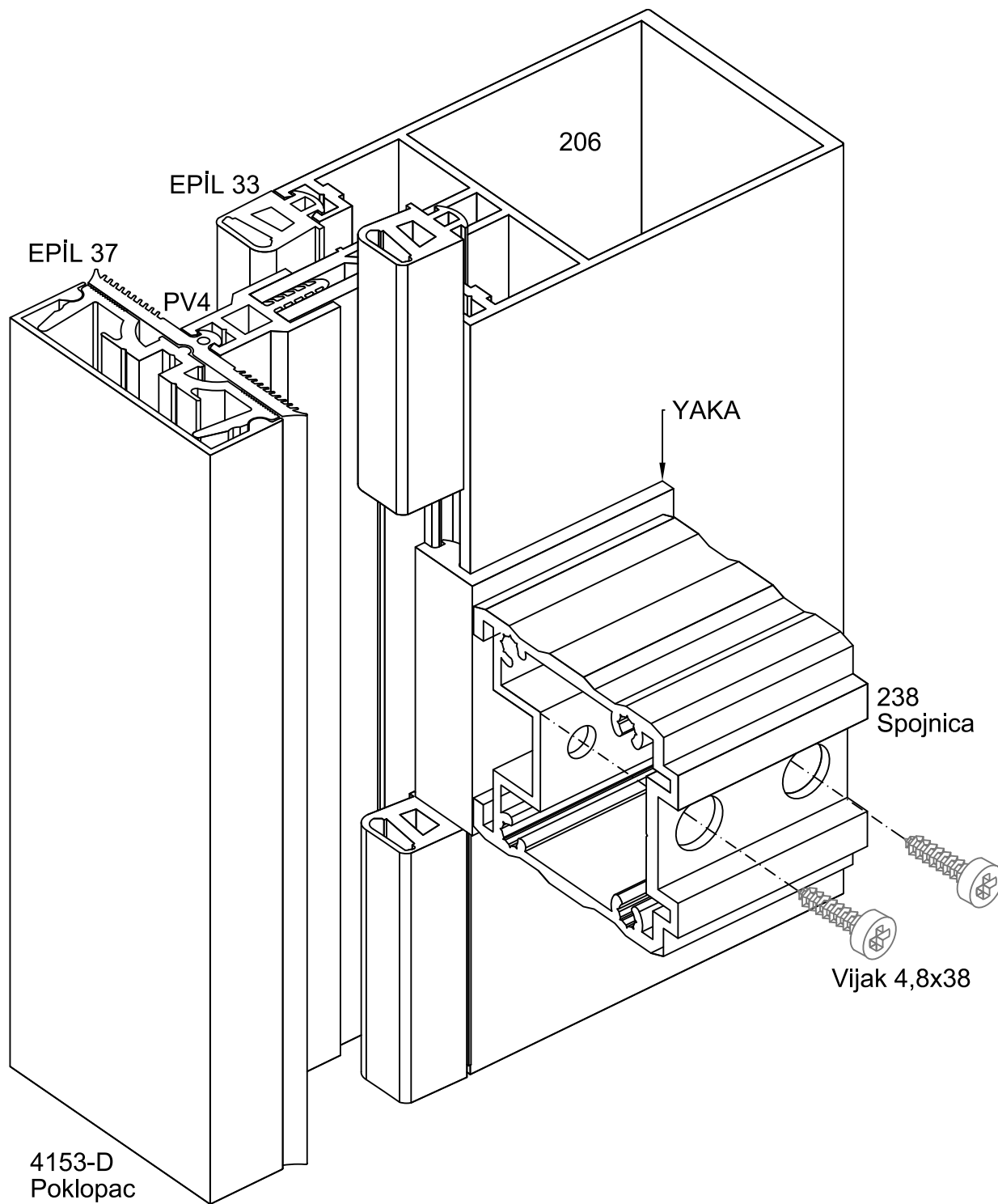

**Veza horizontale**

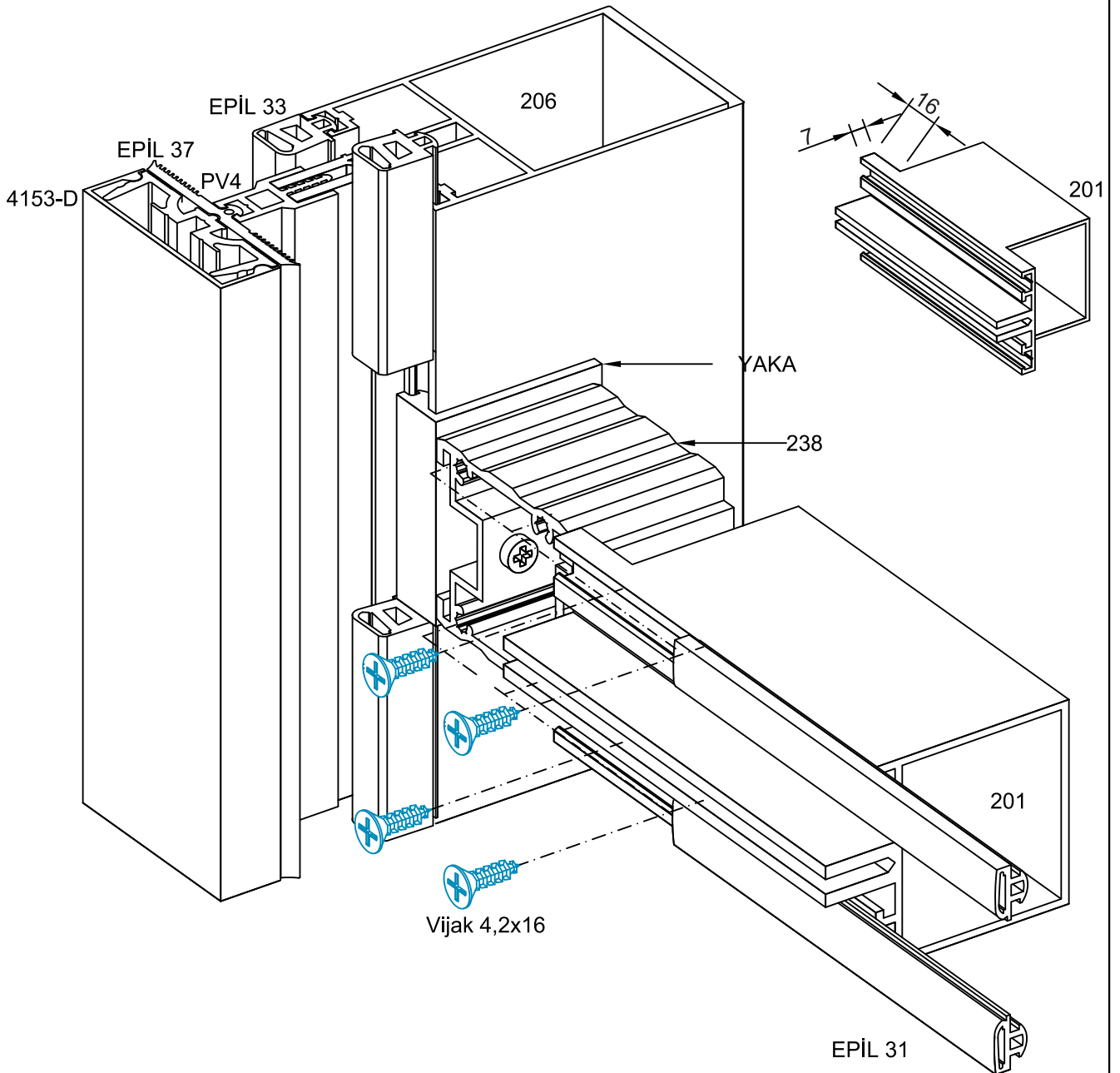
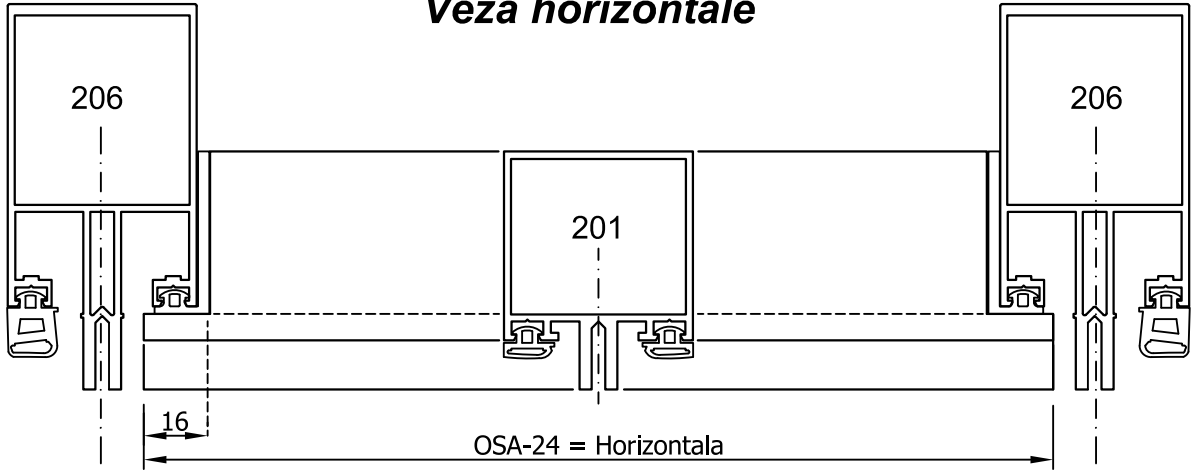

**Veza horizontale**

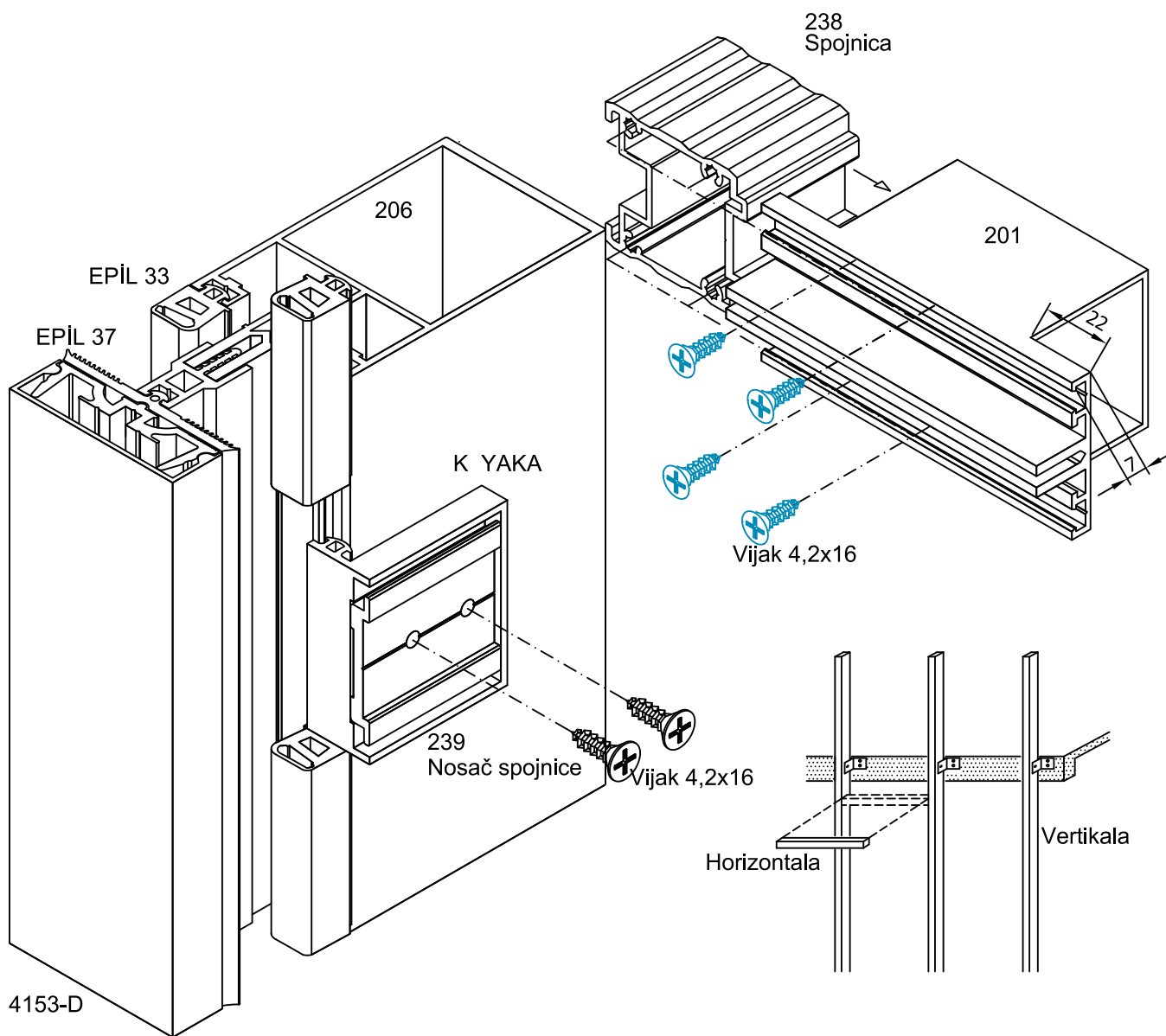
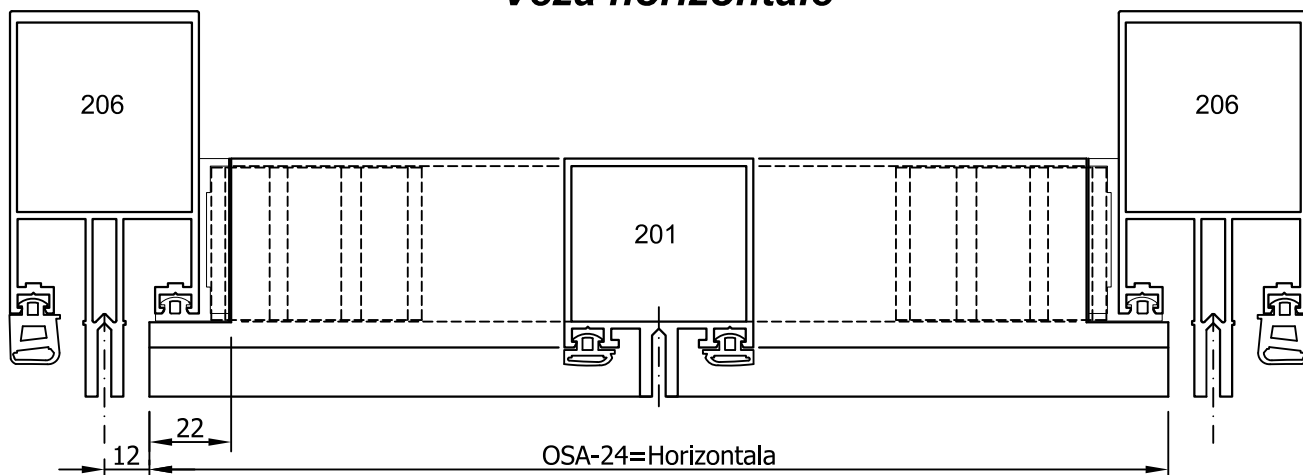

**Veza horizontale**

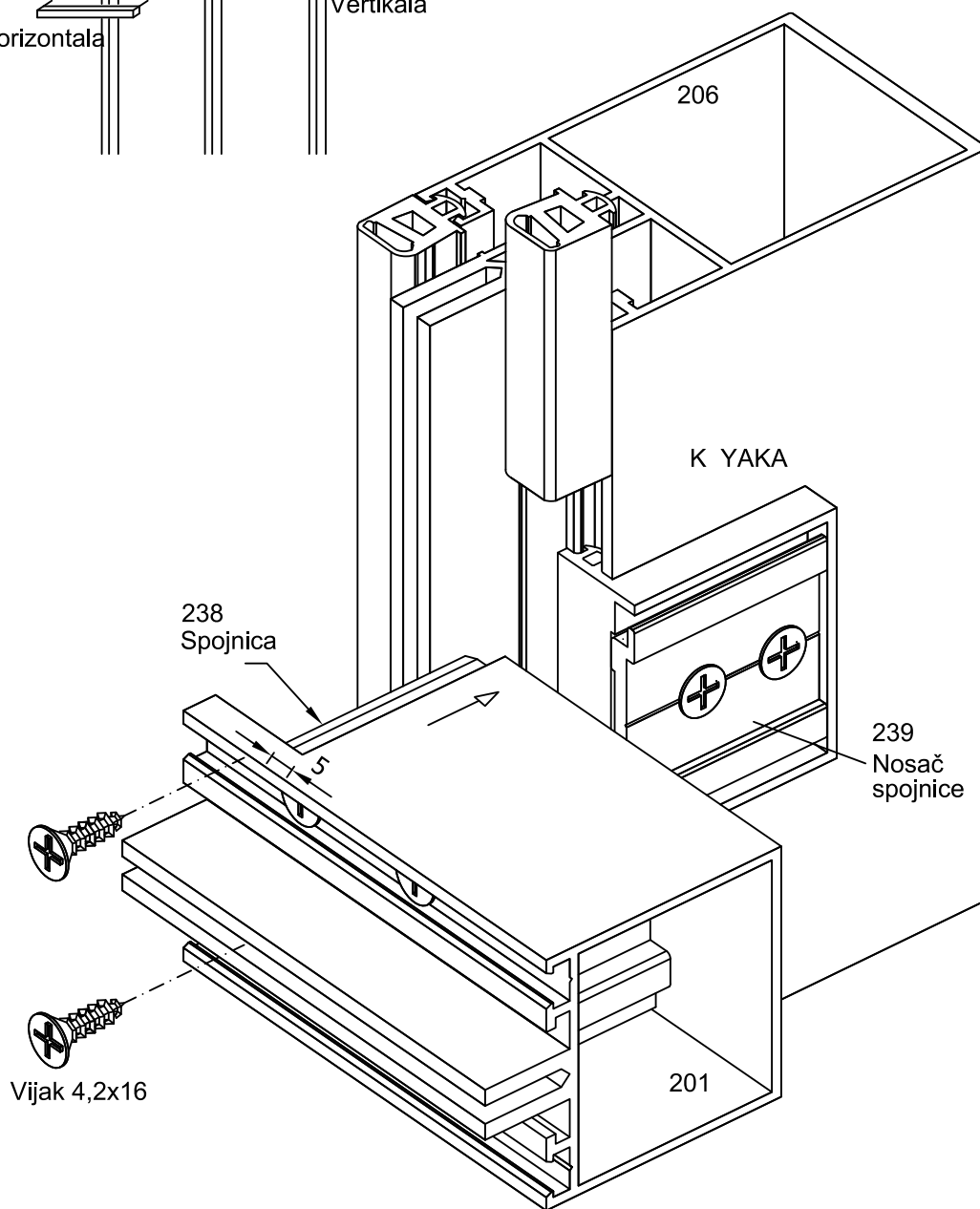
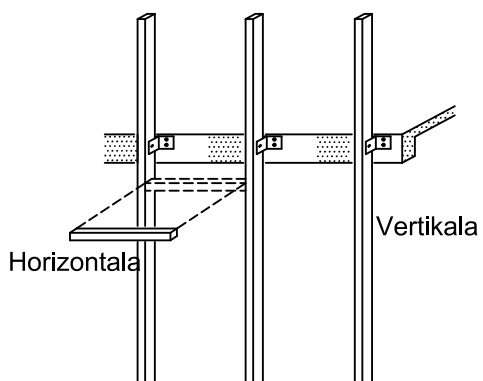

Montaža gumenih profila

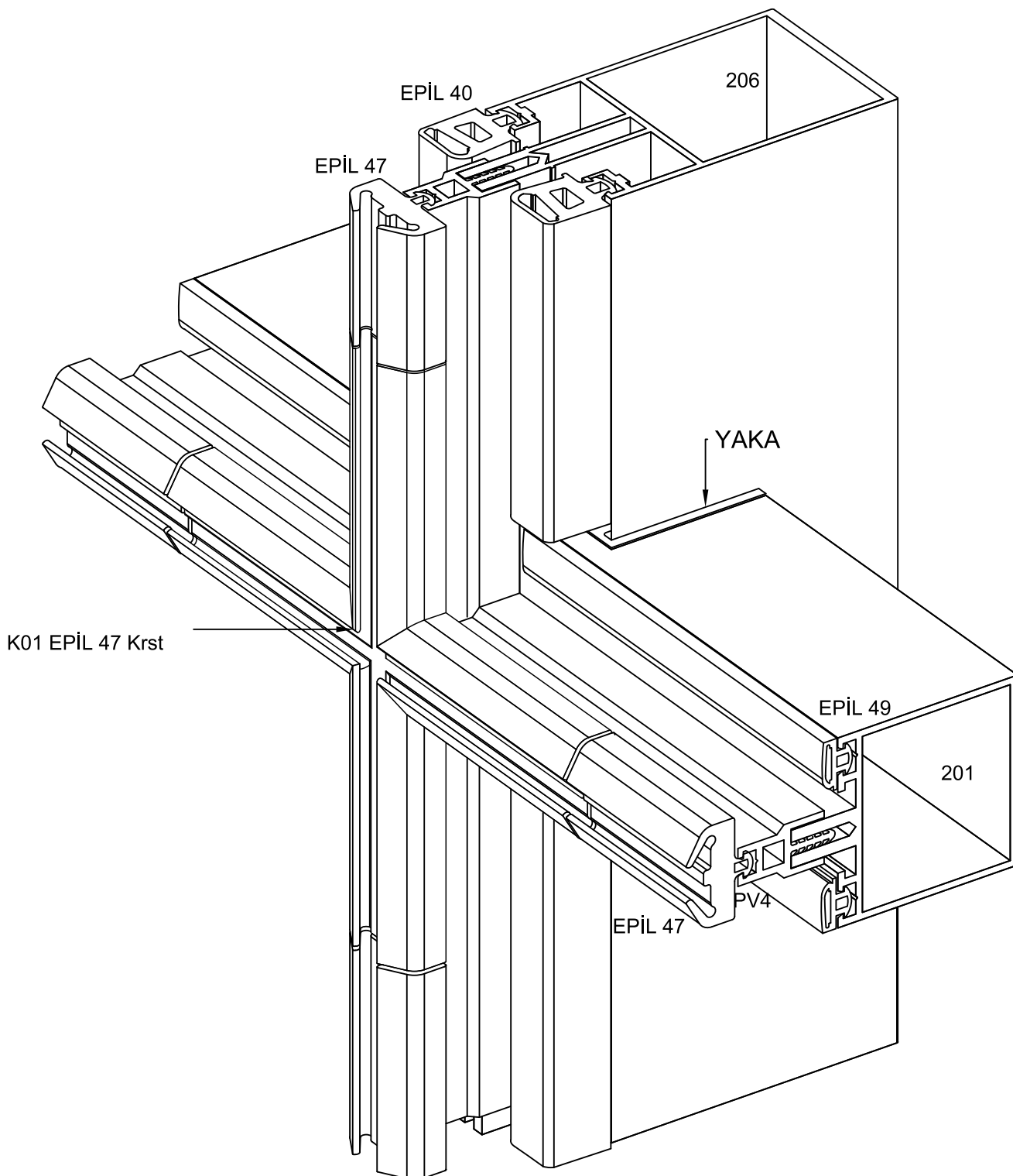

www.proal.rs



• Profili

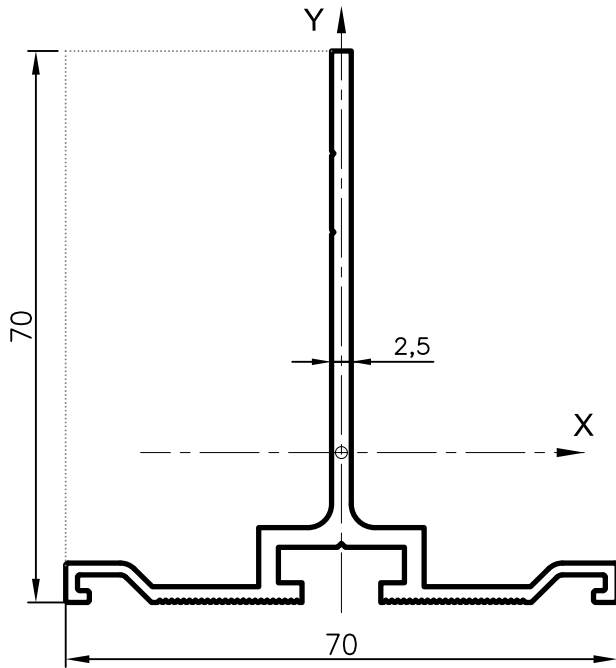

**No : 8598**  $J_x=16.00 \text{ cm}^4$   
 0,910 kg/m  $J_y= 7.01 \text{ cm}^4$

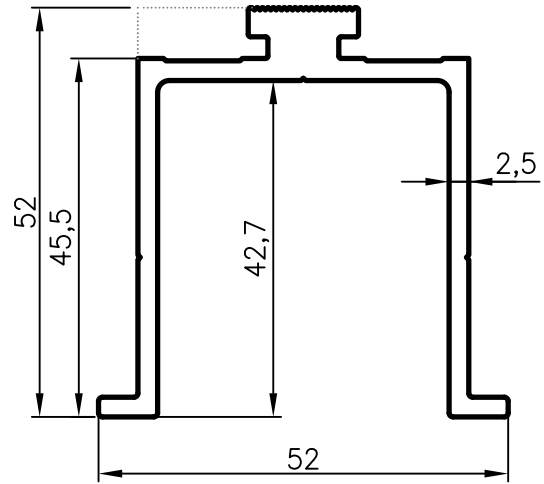

**No : 8599**  
 1,160 kg/m

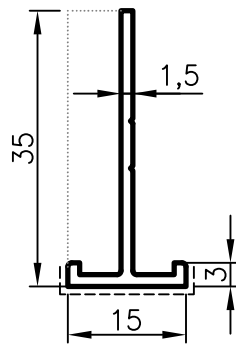

**No : 8707**  
 0,215 kg/m

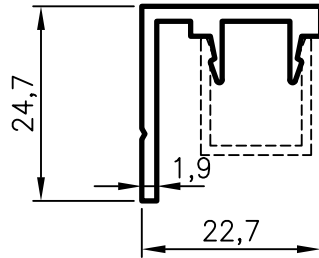

**No : 10332**  
 0,315 kg/m

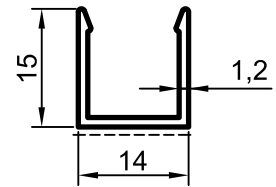

**No : 10333**  
 0,135 kg/m

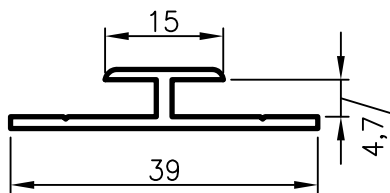

**No : 3452**  
 H Profil  
 0.245 kg/m

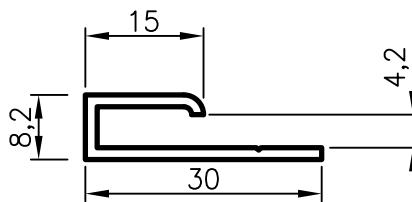

**No : 3454**  
 Završni Profil  
 0.205 kg/m

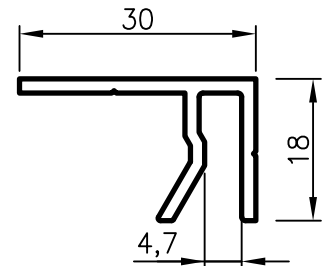

**No : 3958**  
 F Profil  
 0.320 kg/m

Profili

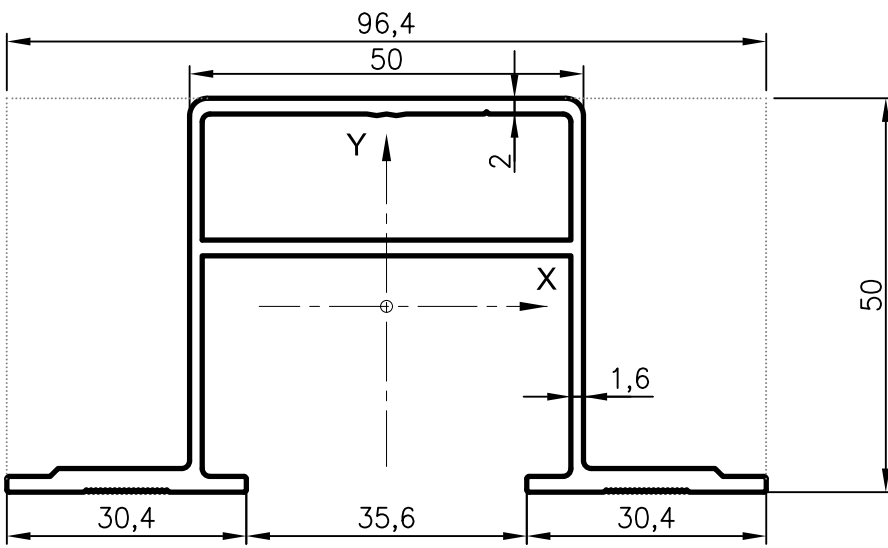

No : 10234  
1,335 kg/m

$J_x=17.09 \text{ cm}^4$   
 $J_y=30.12 \text{ cm}^4$

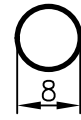

No : 504  
0,140 kg/m

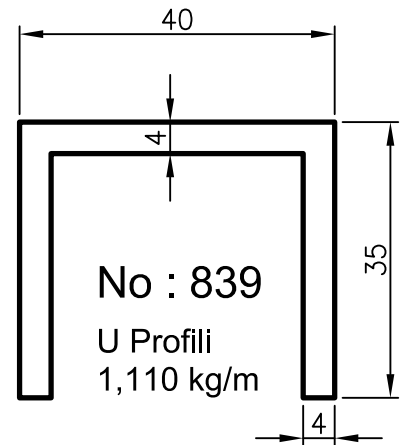

No : 839  
U Profili  
1,110 kg/m

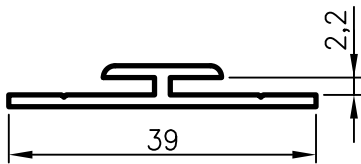

No : 3453  
0.230 kg/m

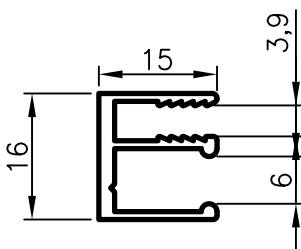

No : 4986

0.220 kg/m

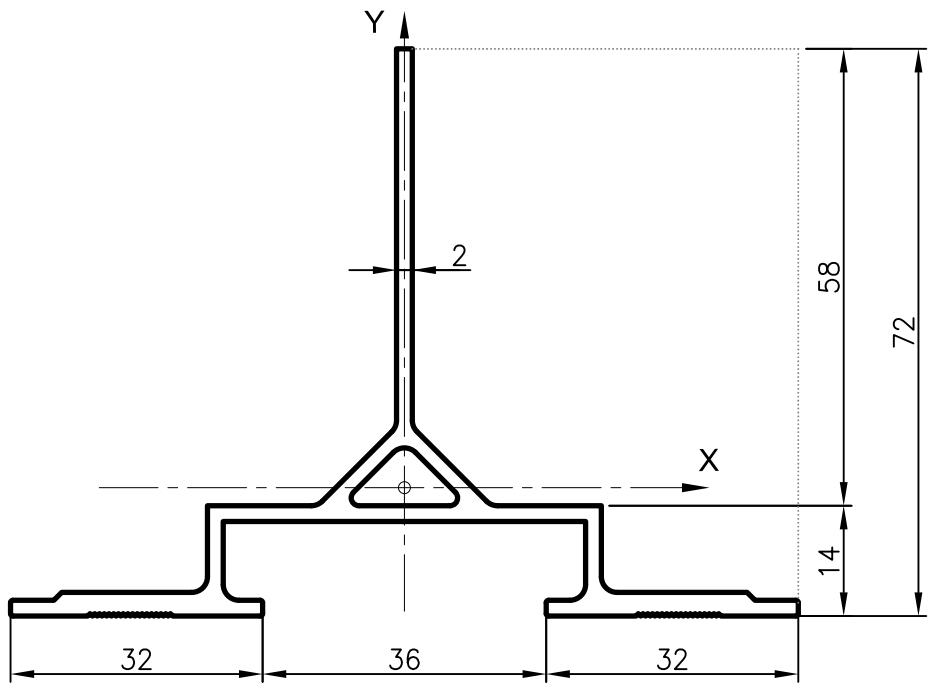

No : 10293  
1,245 kg/m

$J_x= 15.75 \text{ cm}^4$   
 $J_y= 24.88 \text{ cm}^4$

• Profili

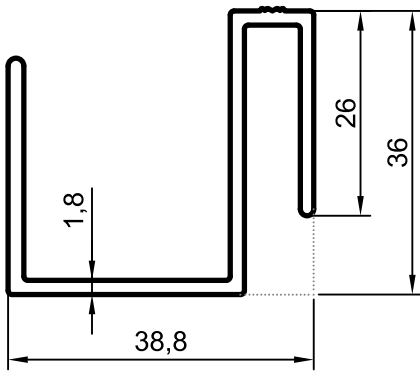

No : 10235  
0,625 kg/m

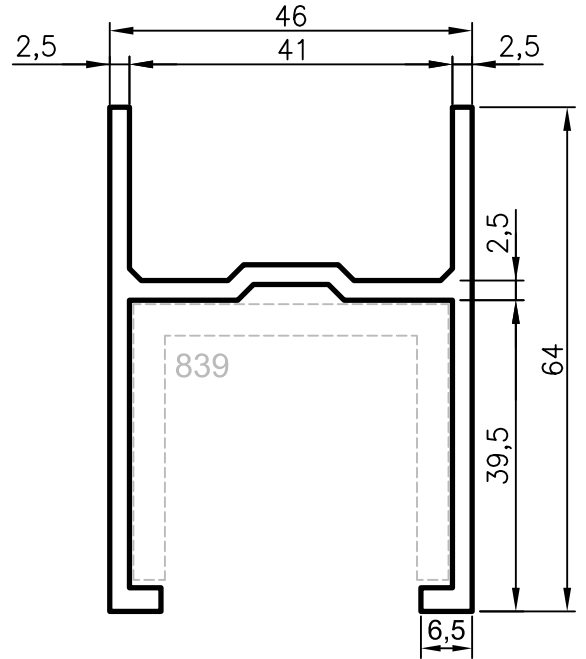

No : 5182  
1,230 kg/m

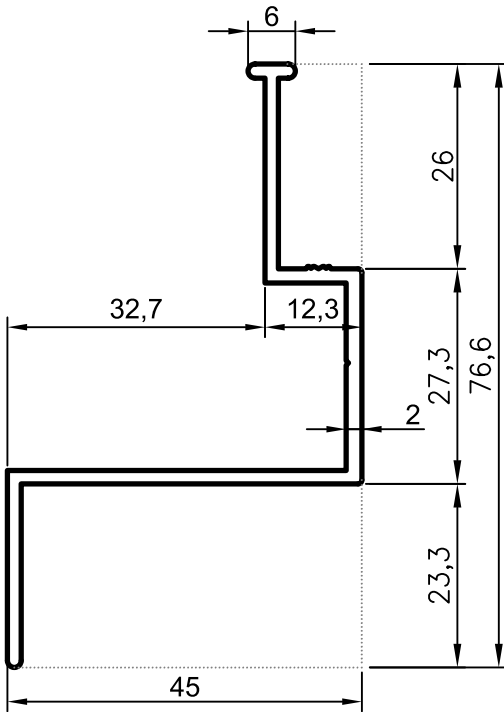

No : 10236  
0,655 kg/m

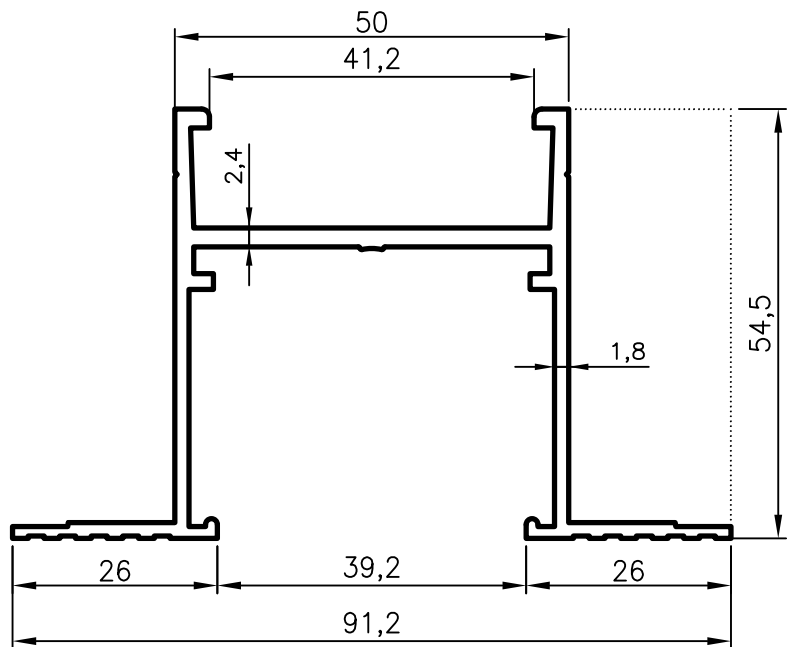

No : 7168  
1,170 kg/m

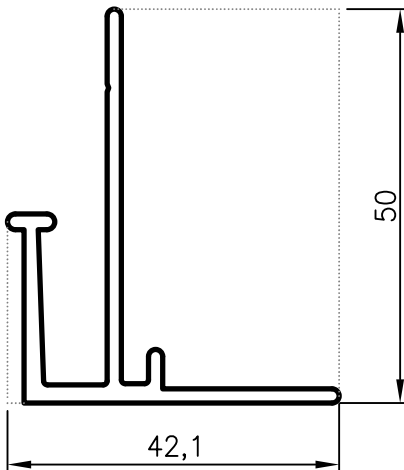

No : 10237  
0,620 kg/m

Napomena: težine profila su teoretske; mere se u trenutku isporuke.



- Anker kotve

L KOTVE

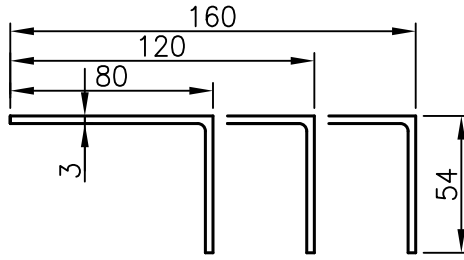

No : 4747  
54X80 L  
1,075 kg/m

No : 4748  
54X120 L  
1,400 kg/m

No : 4749  
54X160 L  
1,725 kg/m

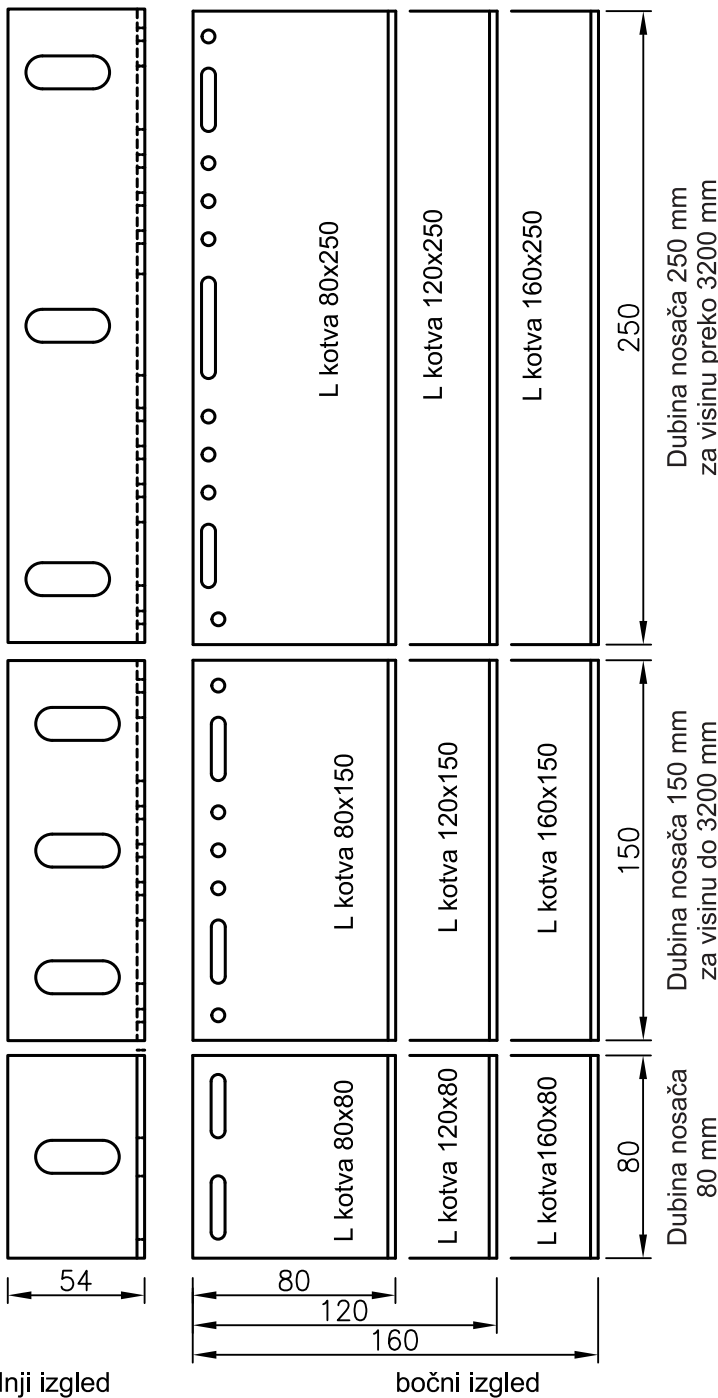

prednji izgled

bočni izgled

Nije u razmeri

Napomena: težine profila su teoretske; mere se u trenutku isporuke.

• Anker kotve

www.proal.rs

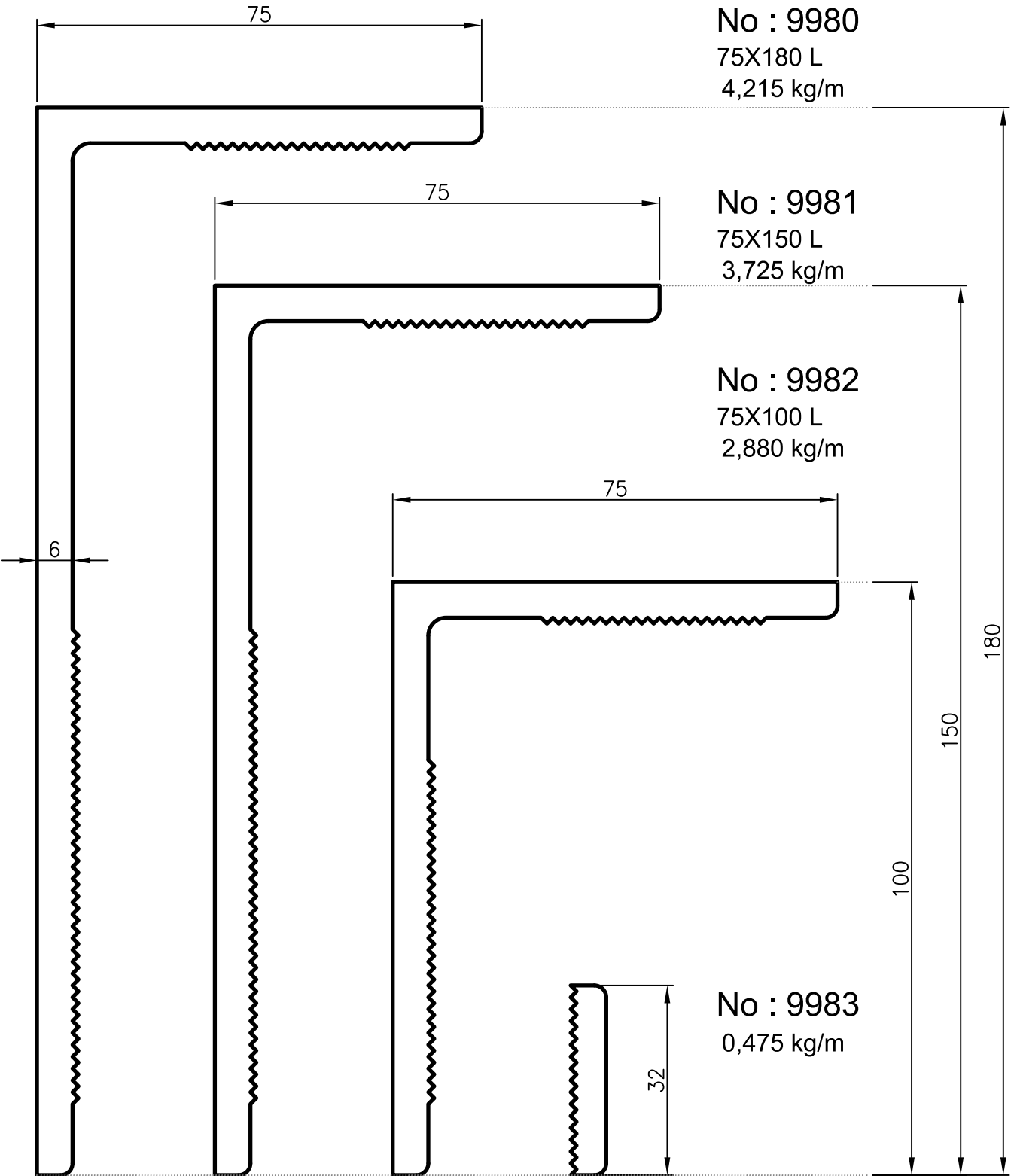

Napomena: težine profila su teoretske; mere se u trenutku isporuke.



• Detalji

Sistem kompozitnih panela

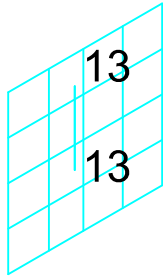

SARAYBOND Kompozitni Panel

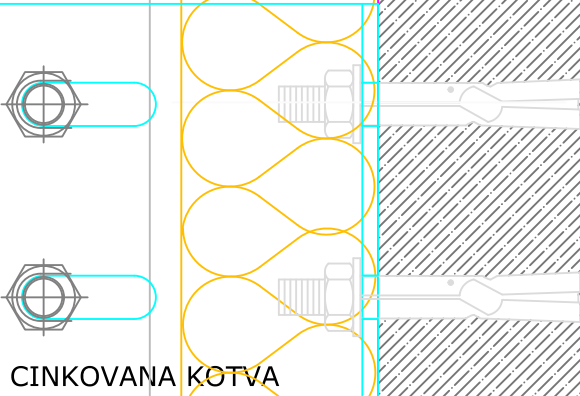
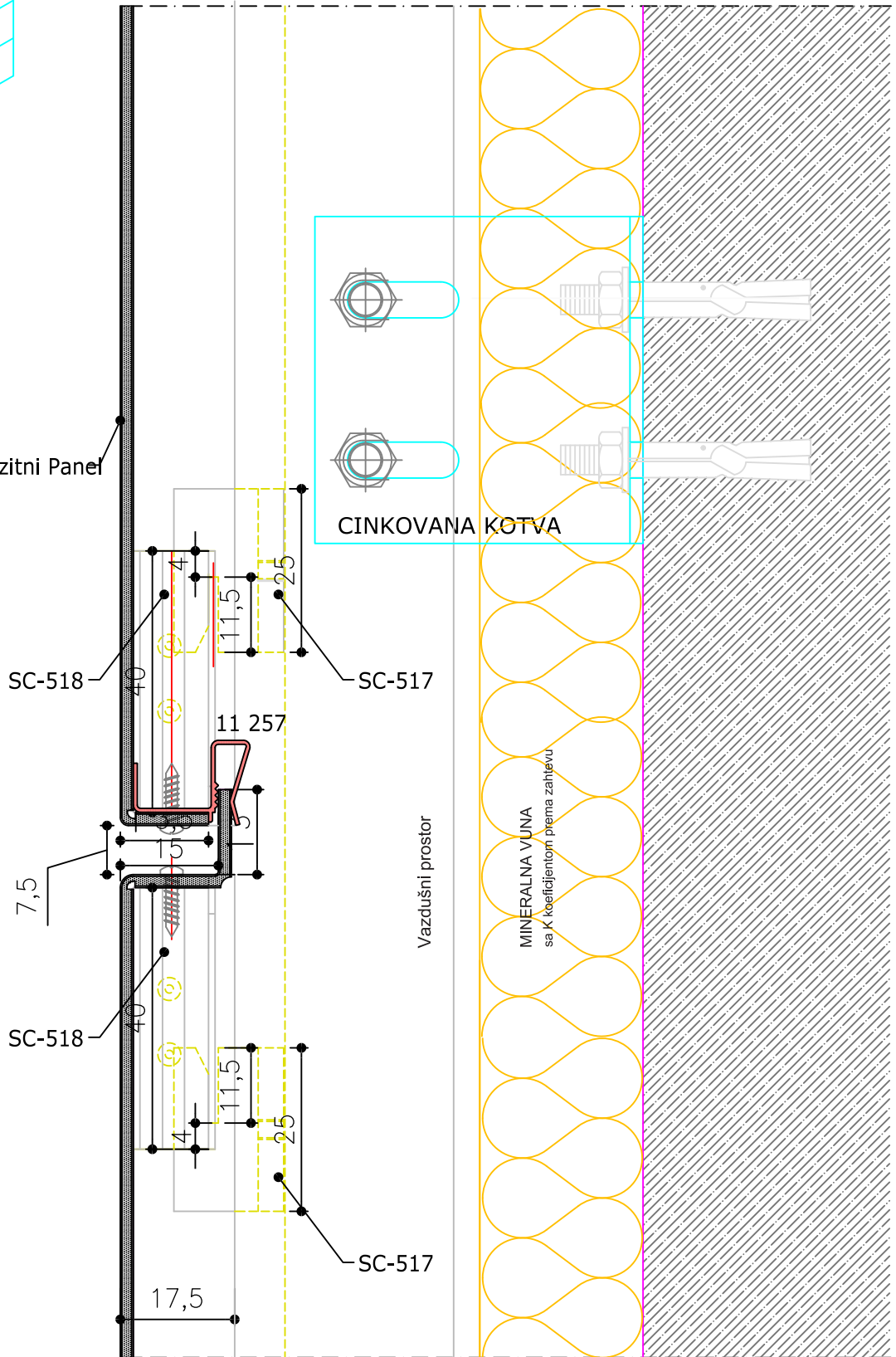

MINERALNA VUNA  
sa K koeficijentom priema zahlevu

Vazdušni prostor

Razmera: 1 / 2

Detalj13

• Detalji

Sistem kompozitnih panela

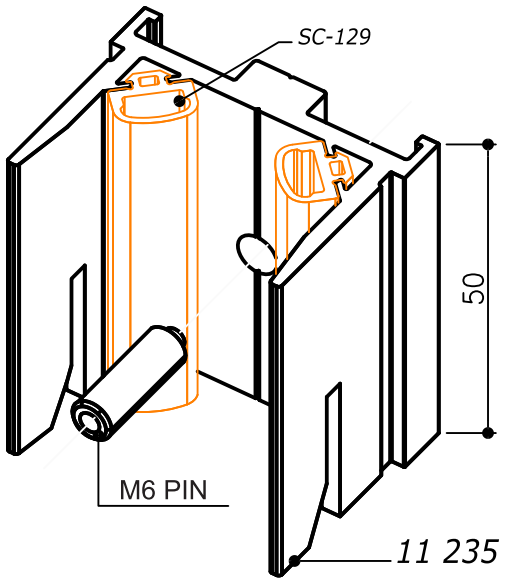

SC-517

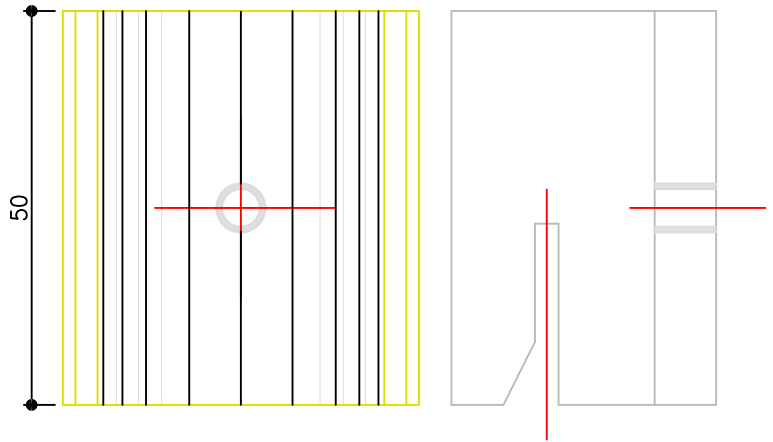

**SC-518**  
Pr. No: 11 236  
Prodaje se na meru od 80 mm.

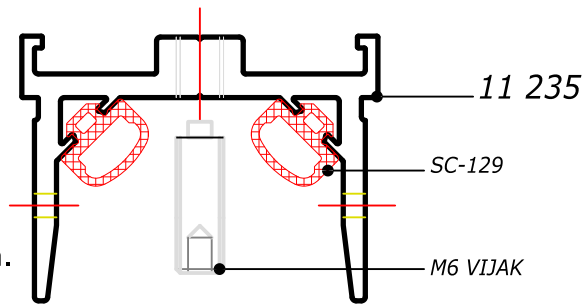

**SC-519**  
Pr. No: 11 236  
Seći na 72mm.  
Prodaje se kao profil

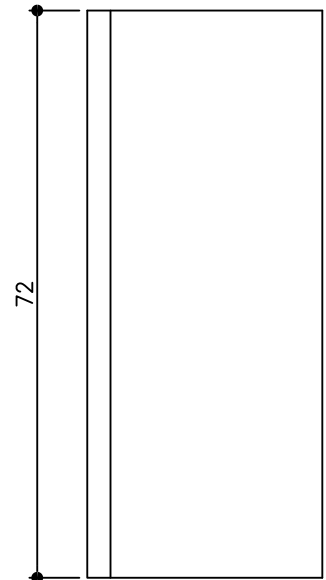
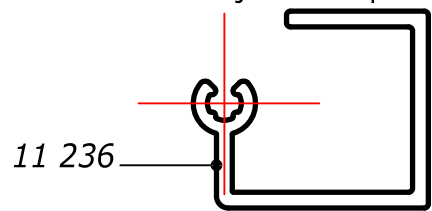
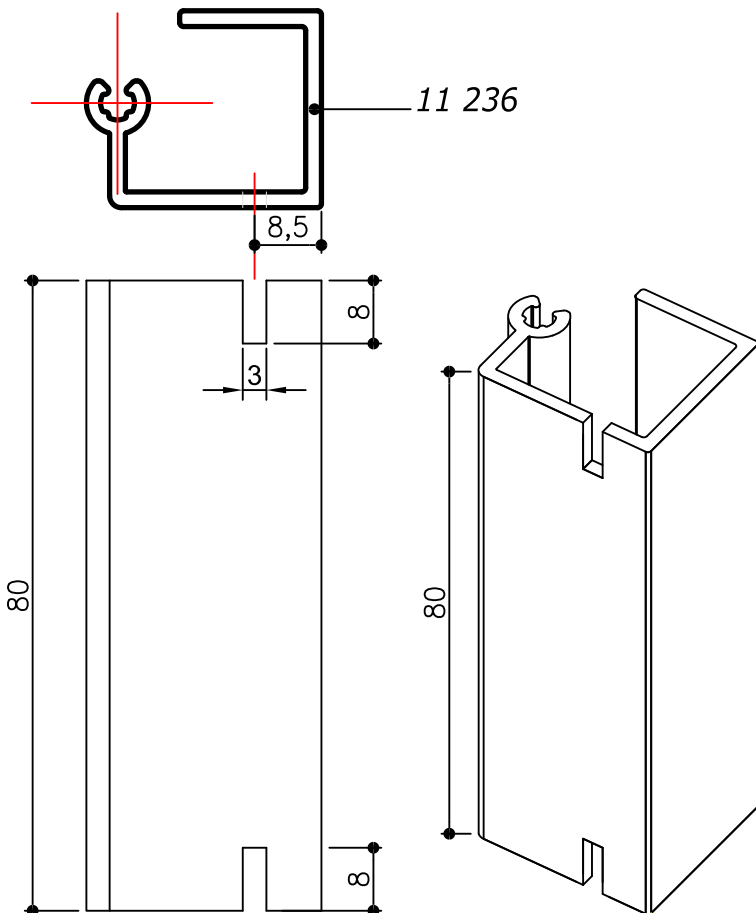

• Detalji

Sistem kompozitnih panela

Primer izrade kasete

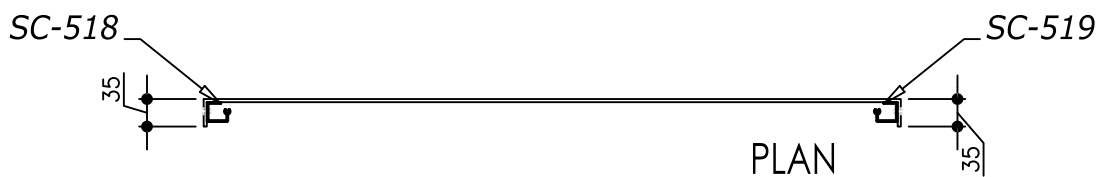
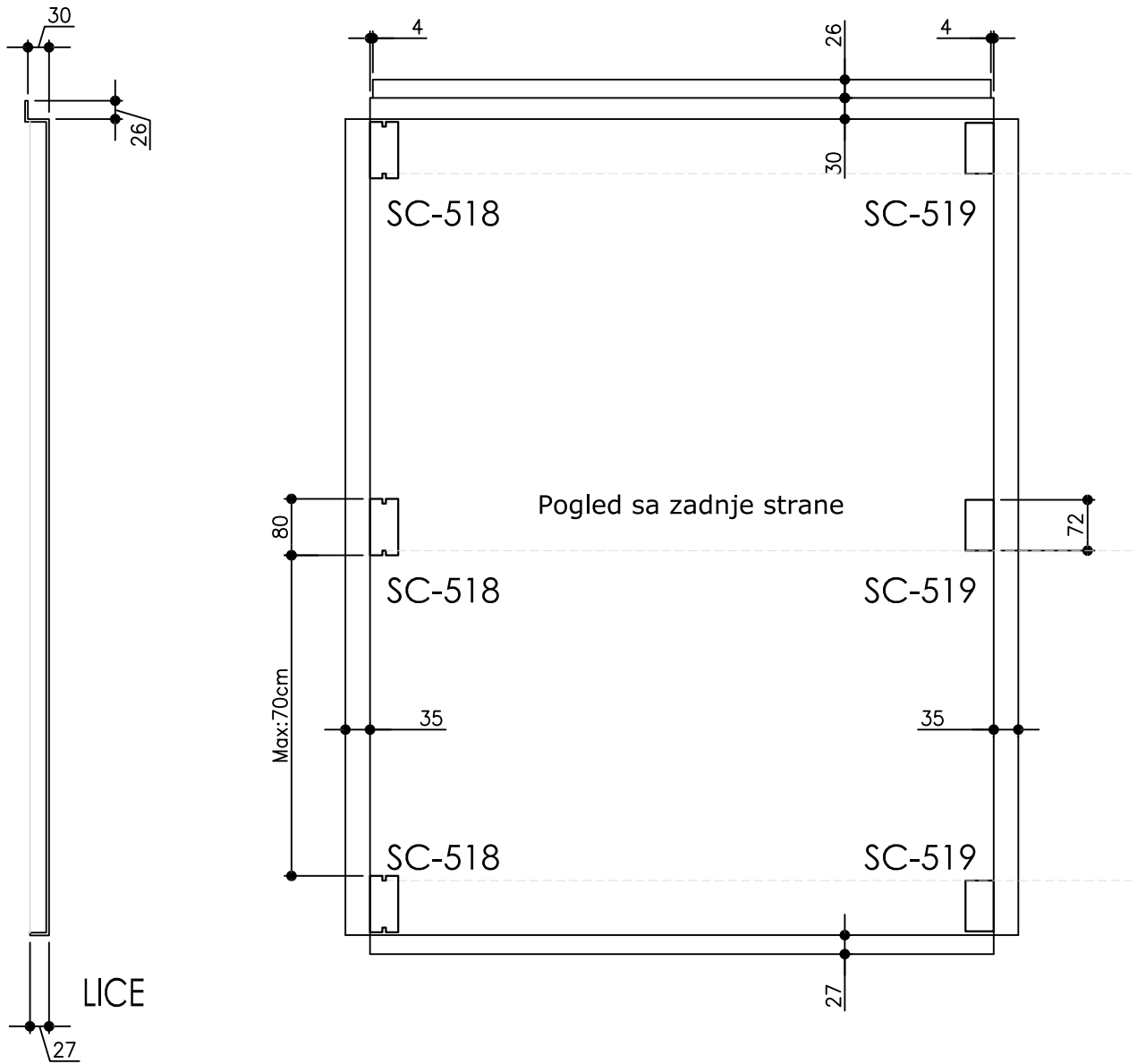

**Upozorenje:**

Debljina kompozitnih ploča i detalji za montažu moraju biti odabrani tako da zadovoljavaju statičke vrednosti visine zgrade i opterećenosti vetrom.

- Detalji

Sistem kompozitnih panela

## Primer ugradnje kasete

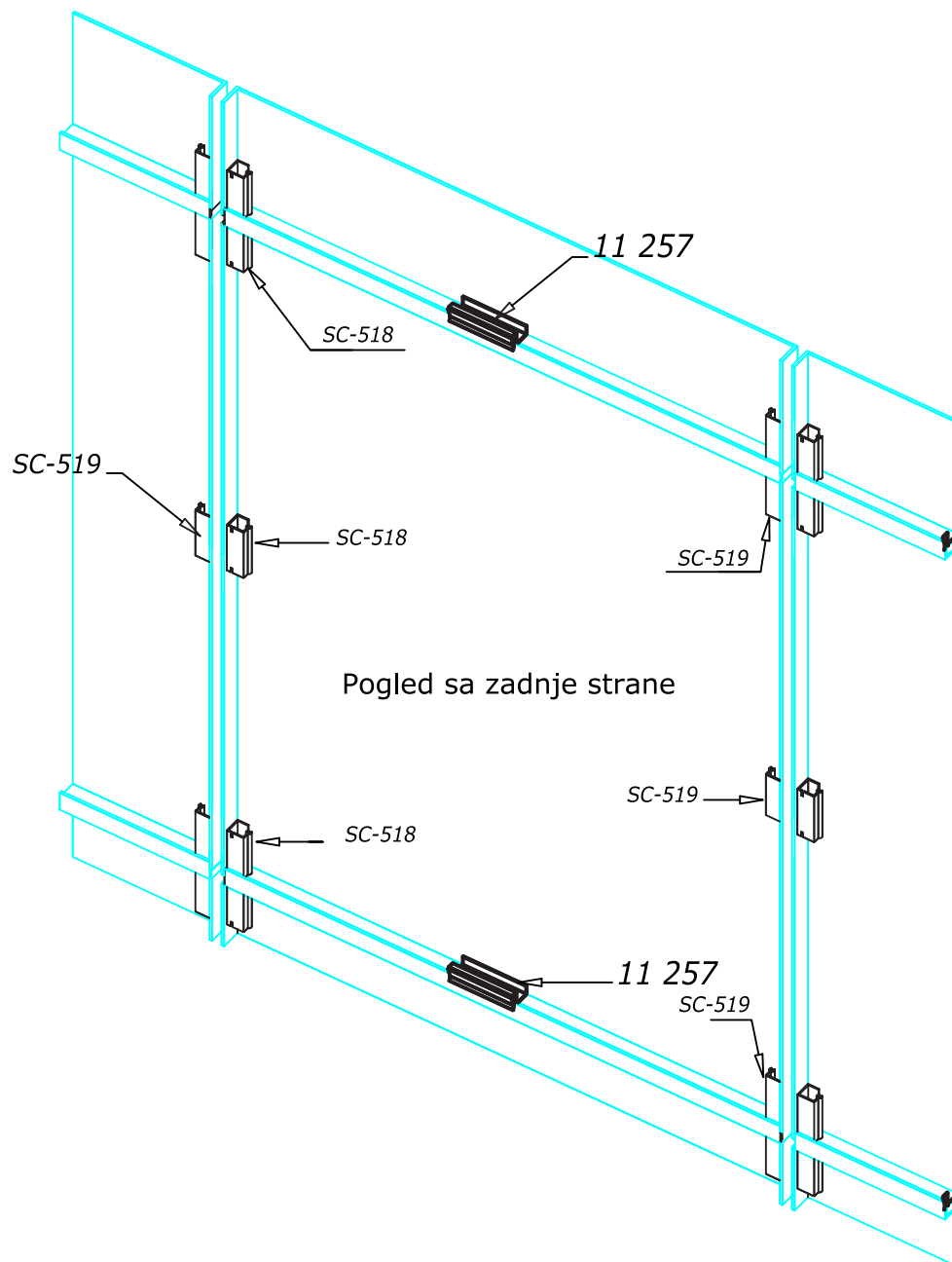

## Upozorenje:

Debljina kompozitnih ploča i detalji za montažu moraju biti odabrani tako da zadovoljavaju statičke vrednosti visine zgrade i opterećenosti vetrom.

Primer ugradnje kasete

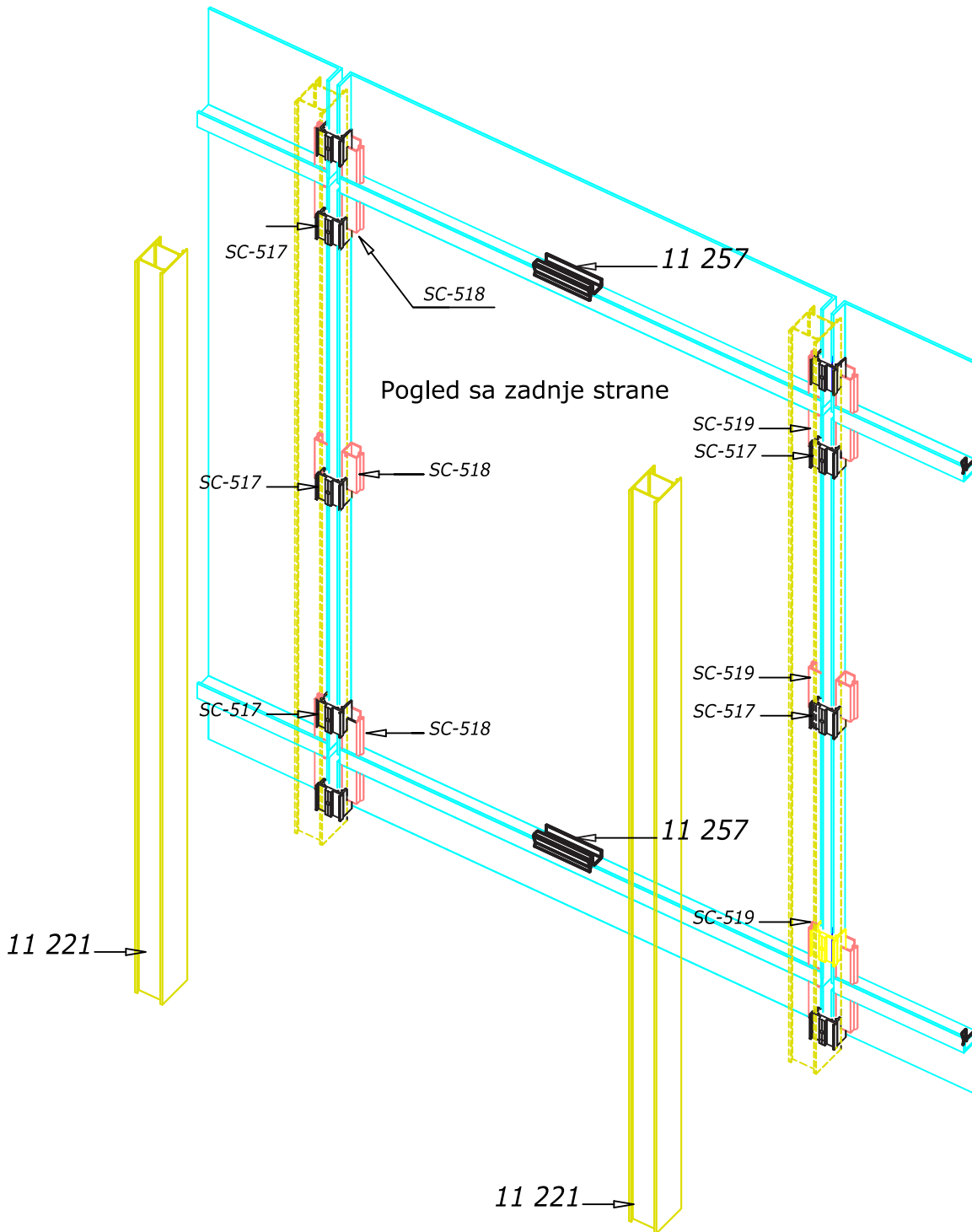

**Upozorenje:**

Debljina kompozitnih ploča i detalji za montažu moraju biti odabrani tako da zadovoljavaju statičke vrednosti visine zgrade i opterećenosti vetrom.



• Detalji

Sistem kompozitnih panela

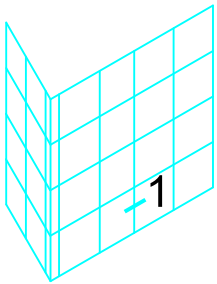

Detalj 1

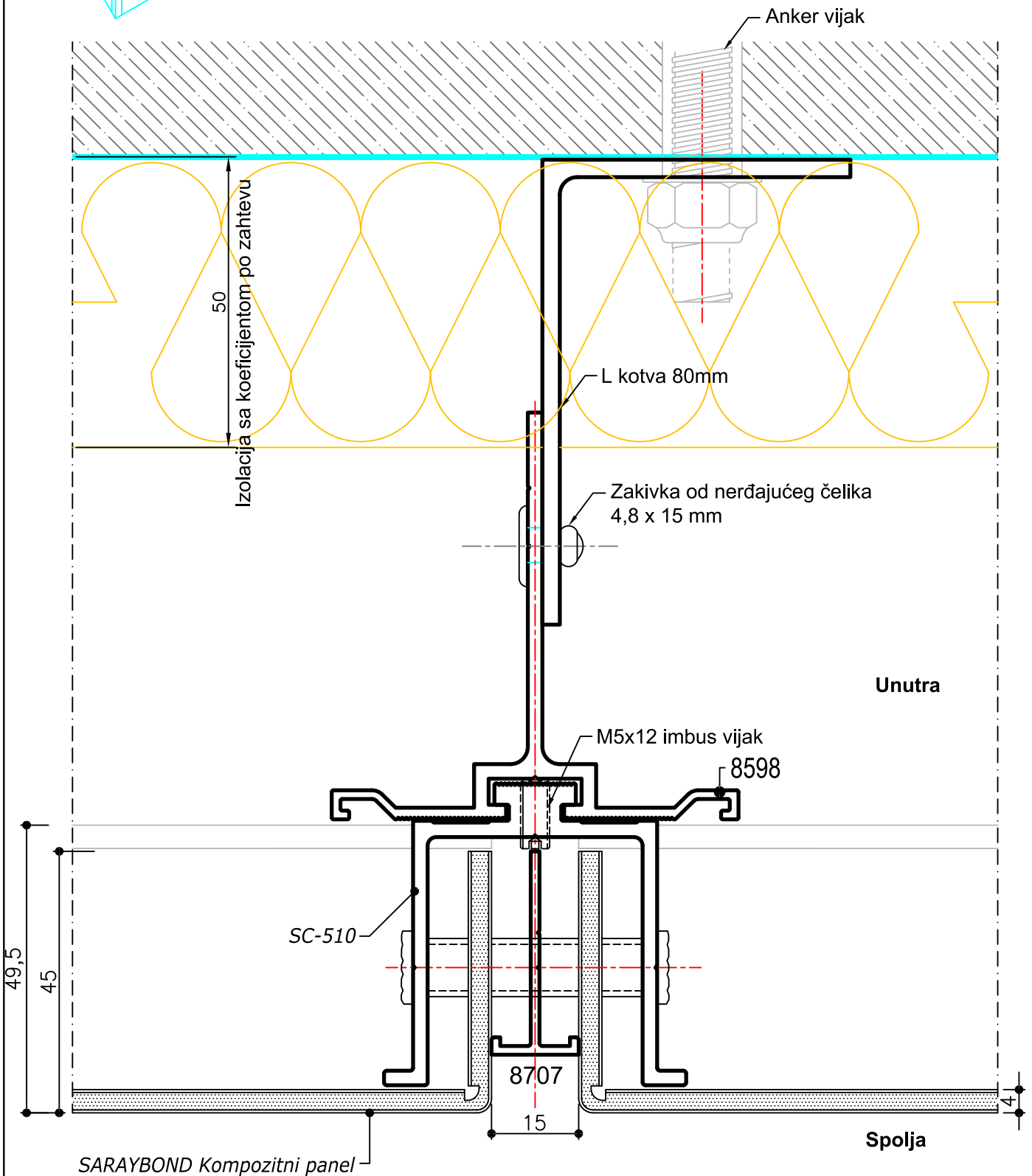

• Detalji

Sistem kompozitnih panela

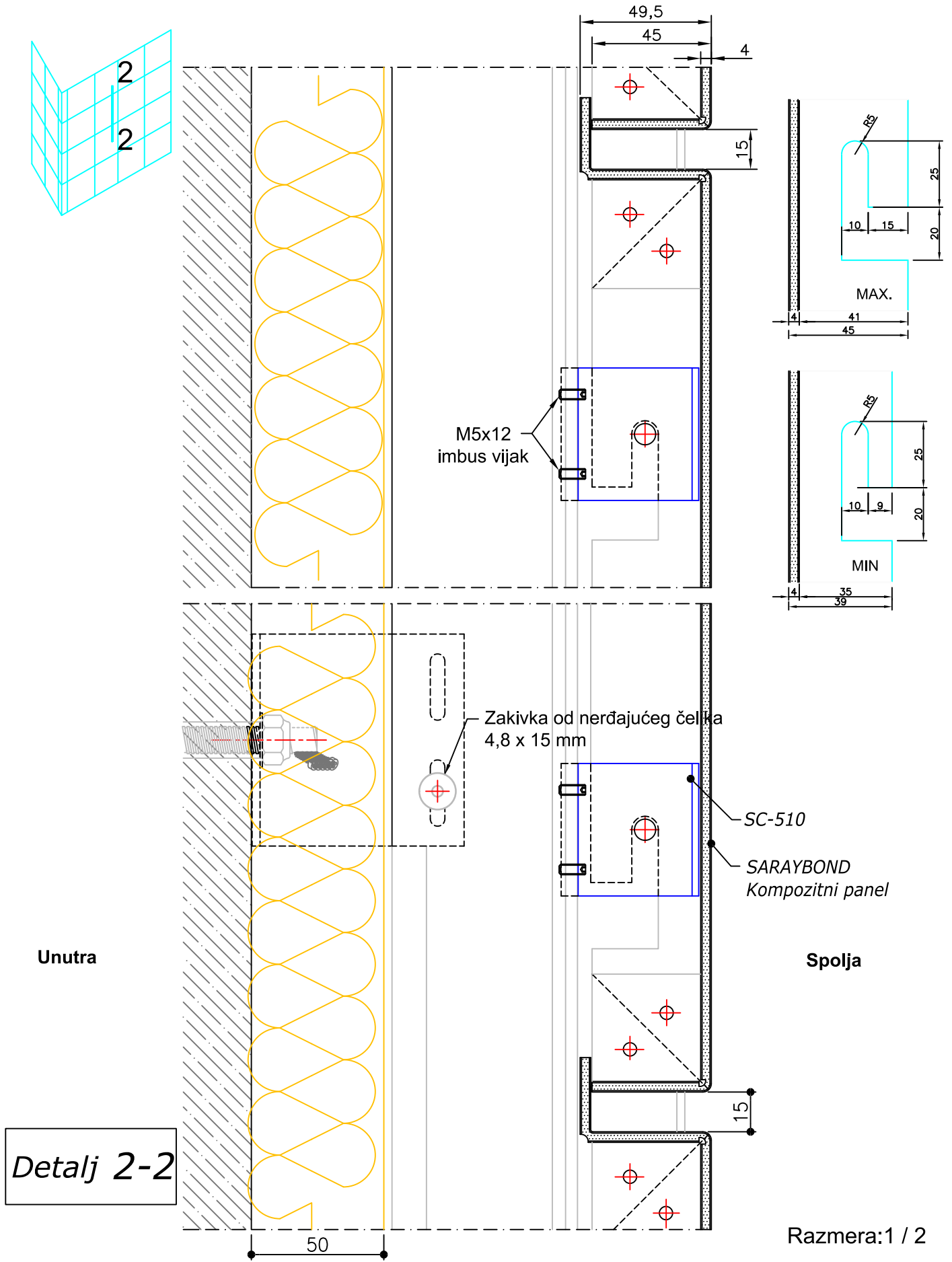

• Detalji

Sistem kompozitnih panela

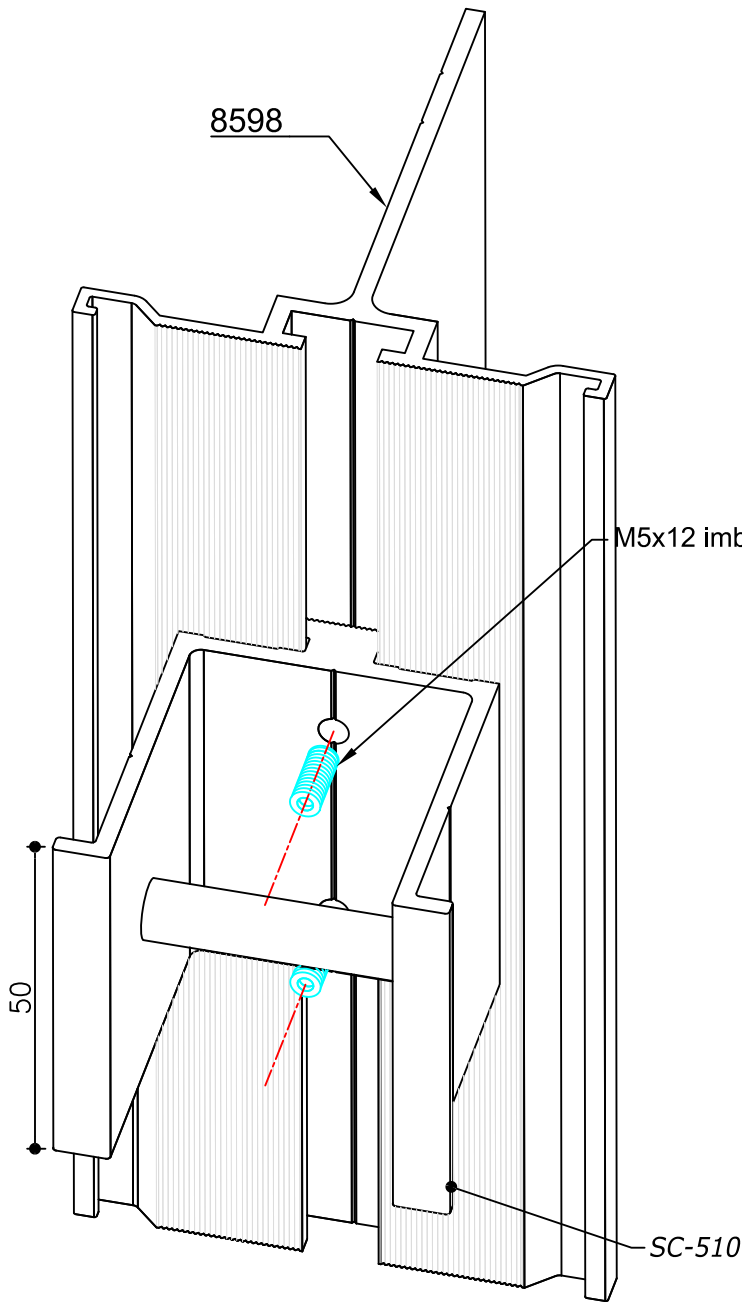

PERSPEKTIVA

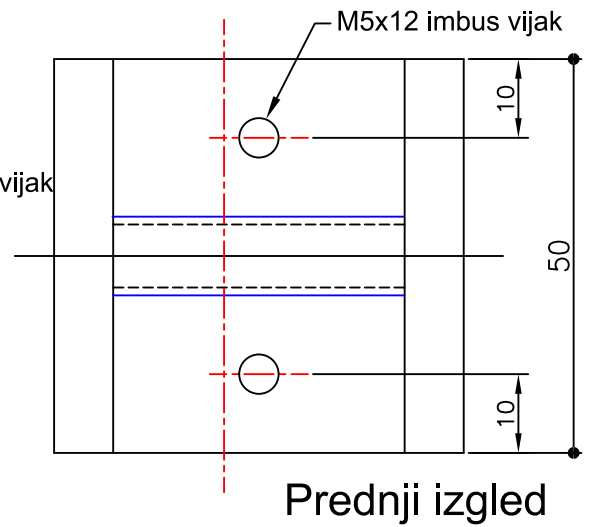

Prednji izgled

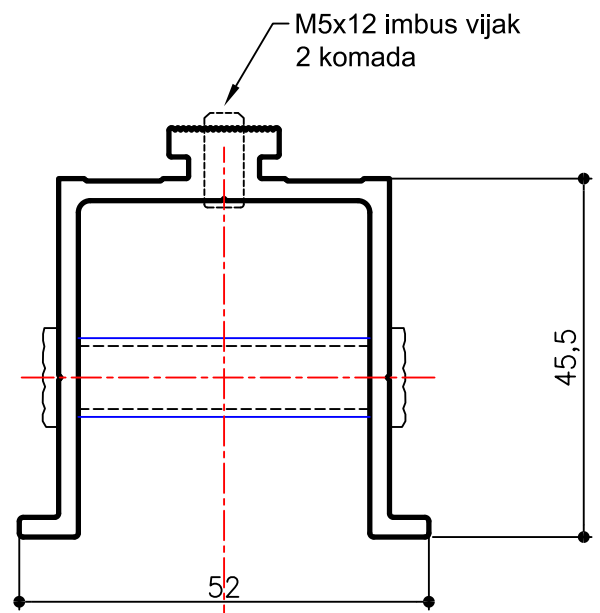

SC-510 (50 kom/pak)

Upozorenje:

Debljina kompozitnih ploča i detalji za montažu moraju biti odabrani tako da zadovoljavaju statičke vrednosti visine zgrade i opterećenosti vetrom.

• Detalji

Otvori za klin

A DETALJ

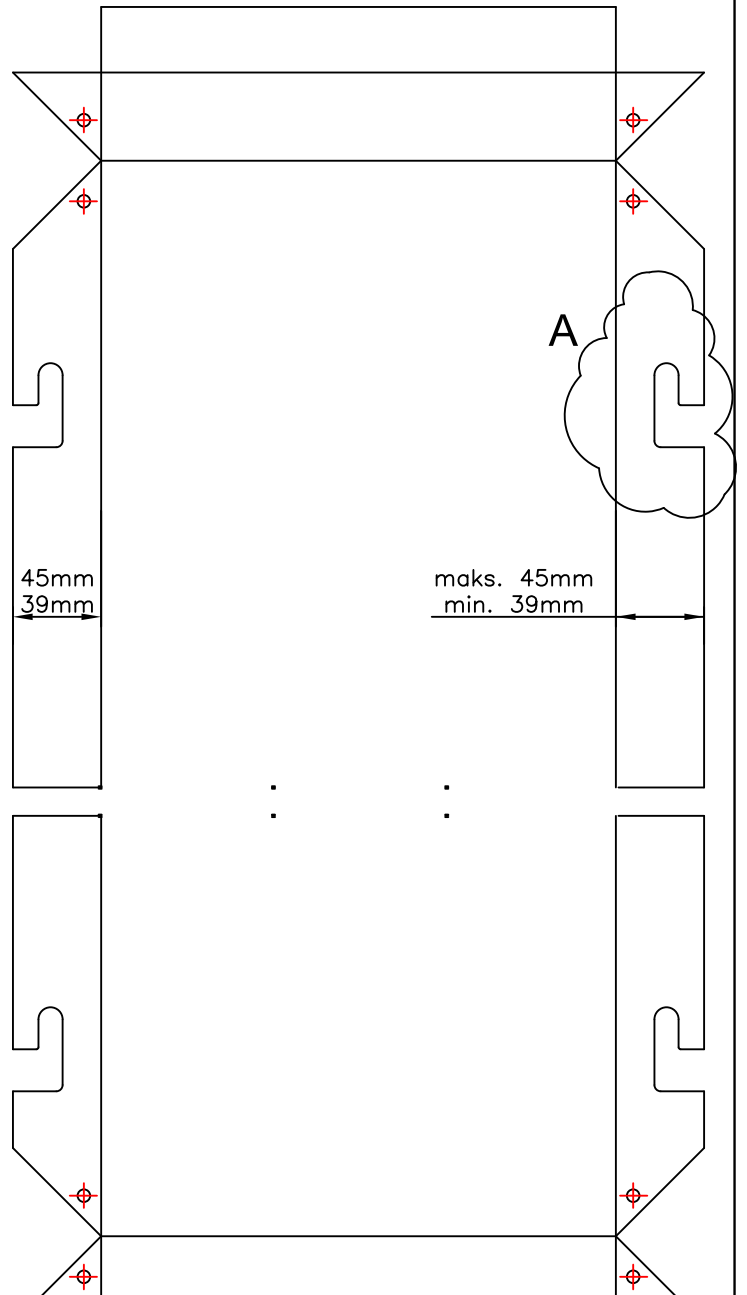
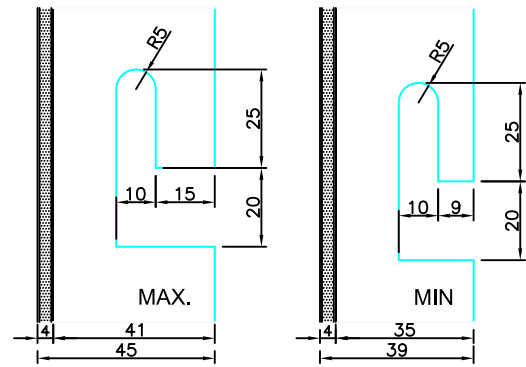
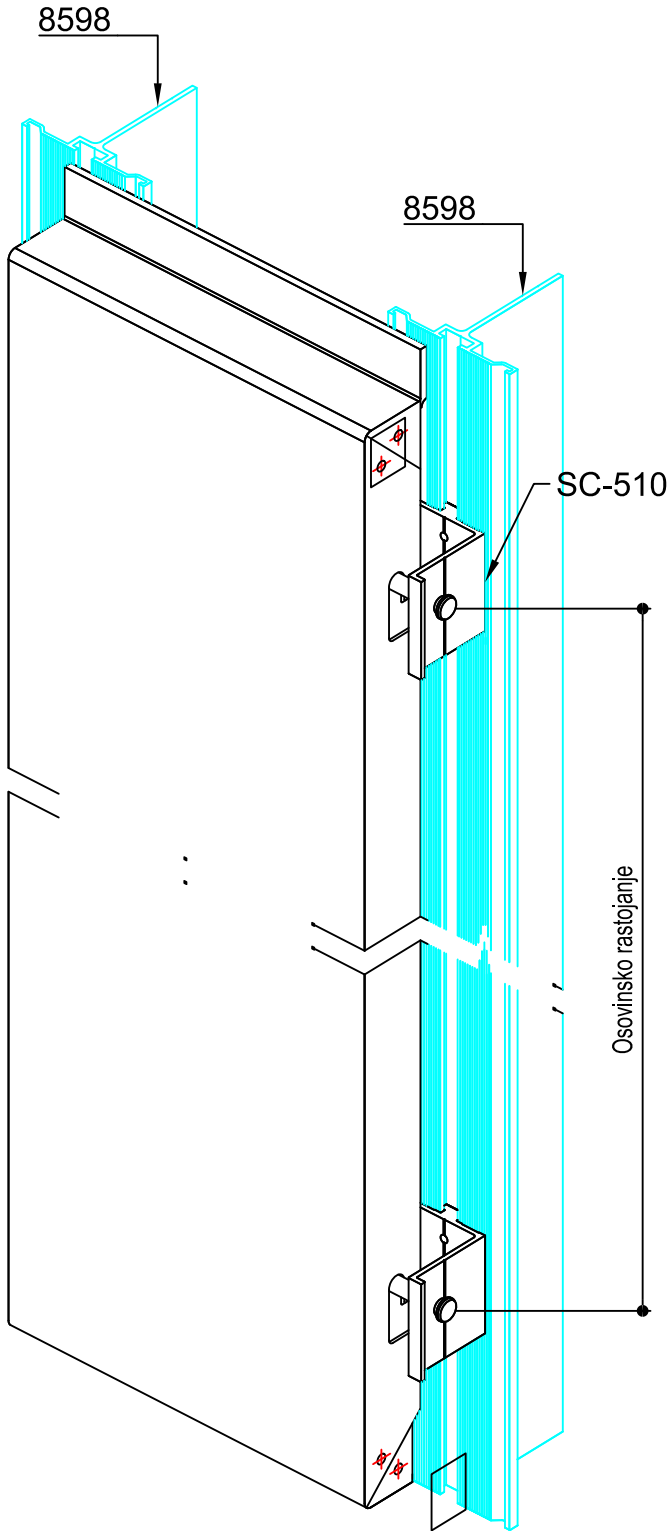

**Upozorenje:**

Debljina kompozitnih ploča i detalji za montažu moraju biti odabrani tako da zadovoljavaju statičke vrednosti visine zgrade i opterećenosti vetrom.

**PERSPEKTIVA**

• Detalji

Sistem kompozitnih panela

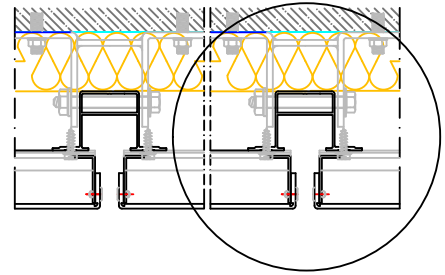
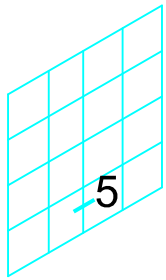

Detalj 5

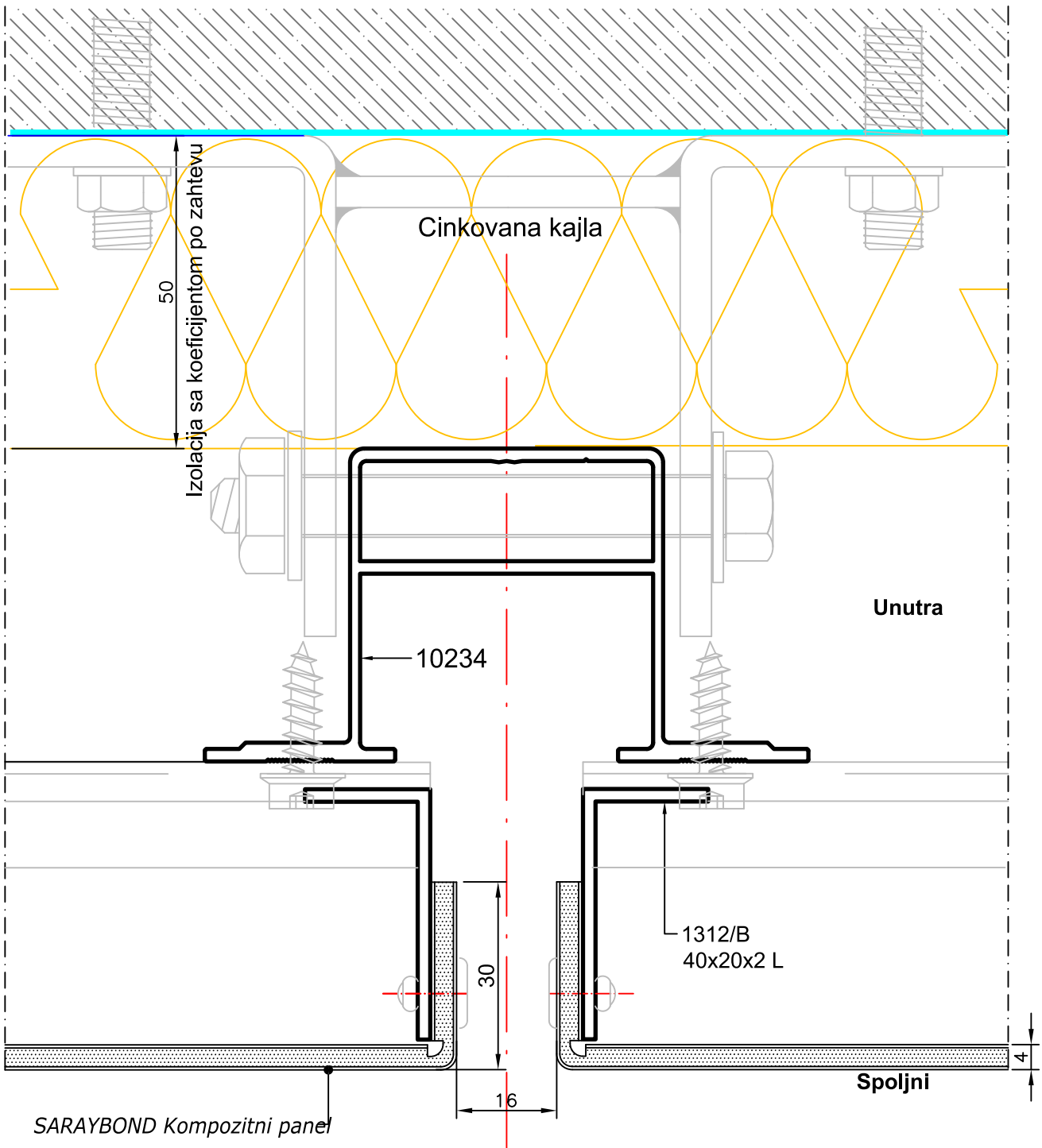

• Detalji

Sistem kompozitnih panela

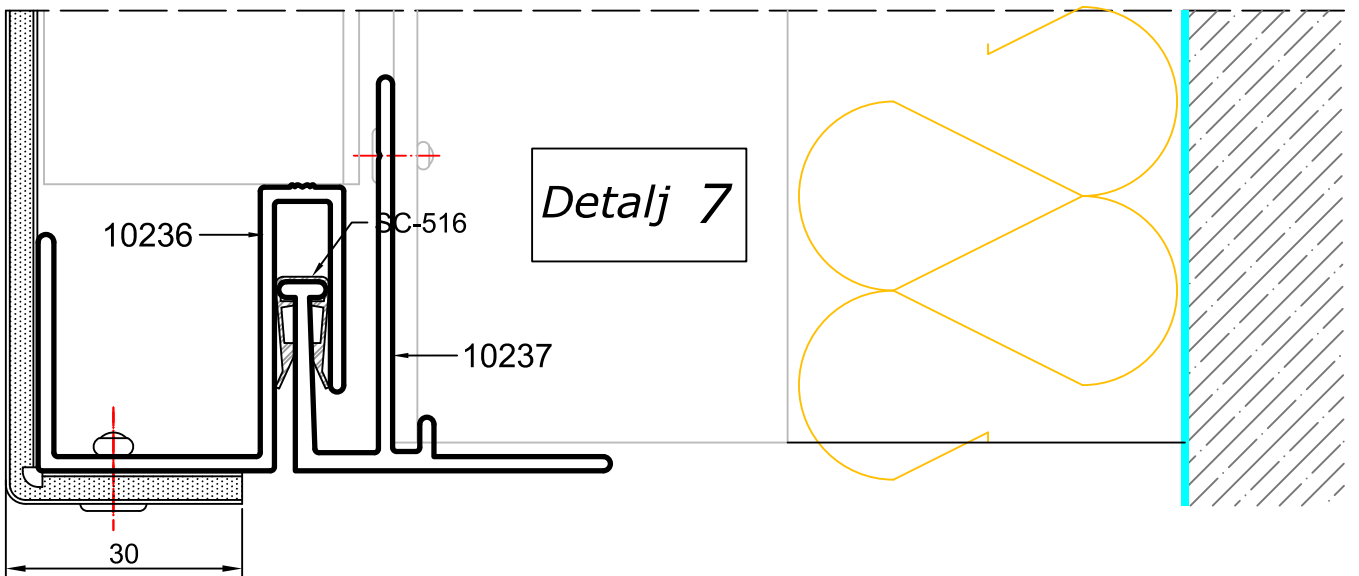
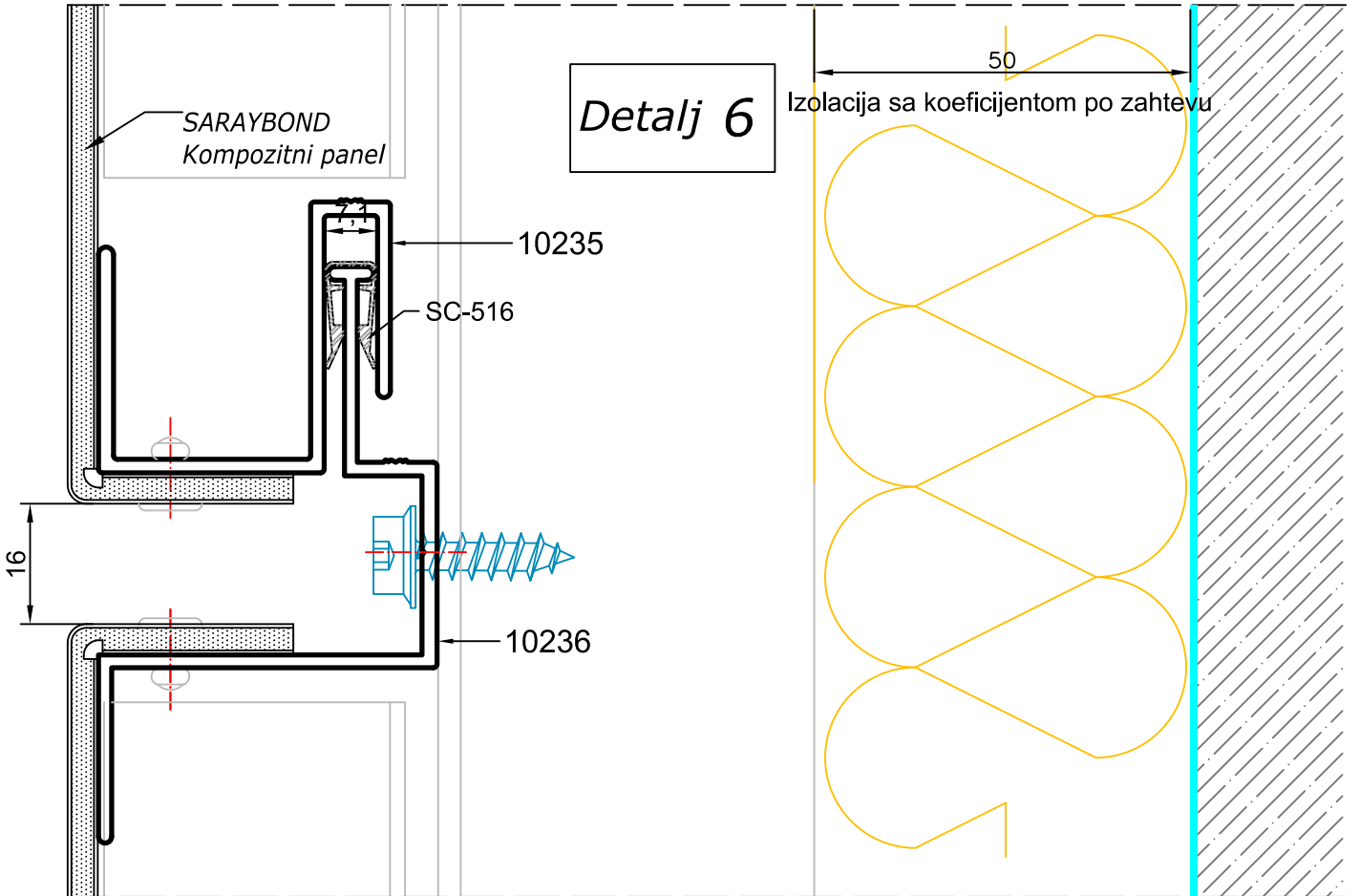
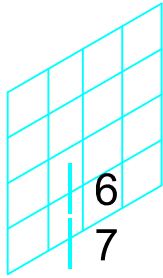

- Detalji

Sistem kompozitnih panela

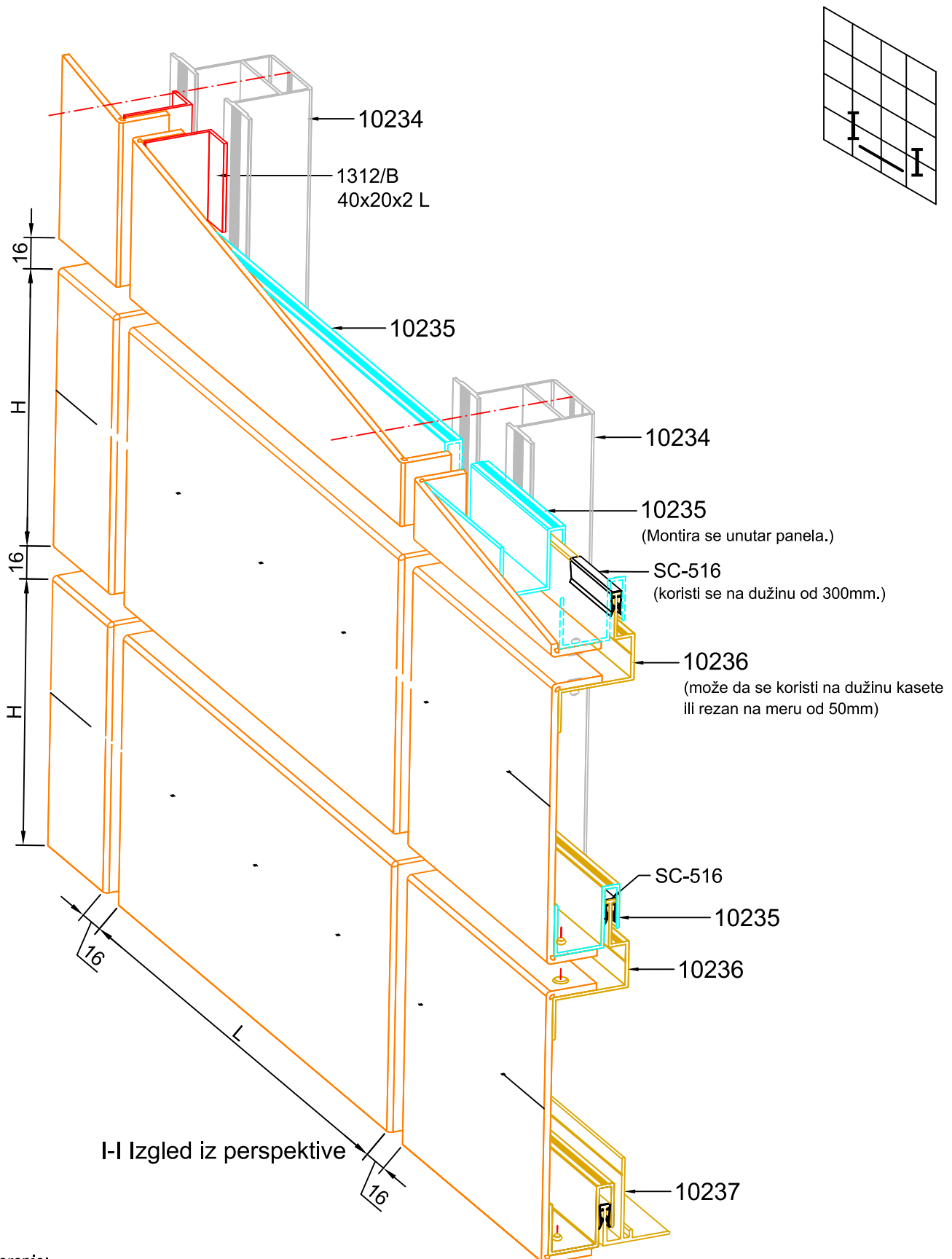

## Upozorenje:

Debljina kompozitnih ploča i detalji za montažu moraju biti odabrani tako da zadovoljavaju statičke vrednosti visine zgrade i opterećenosti vetrom.

• Detalji

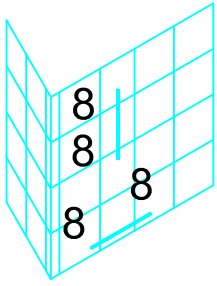

**Detalj 8-8**

Unutra

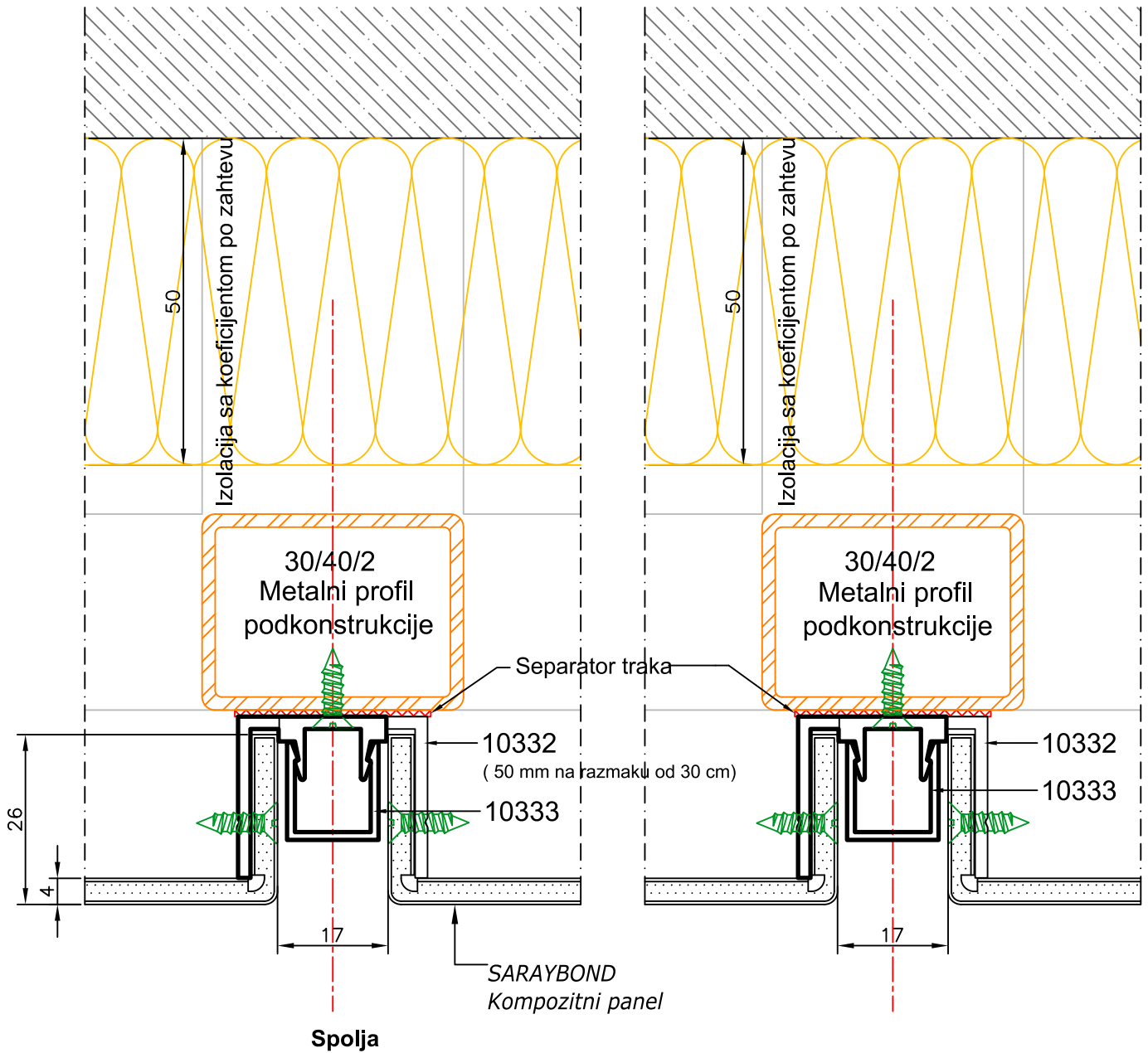

Upozorenje: Cevi podkonstrukcije moraju biti antikorozivno zaštićene u skladu sa statičkim proračunom za podkonstrukciju.



- Detalji

## Sistem kompozitnih panela

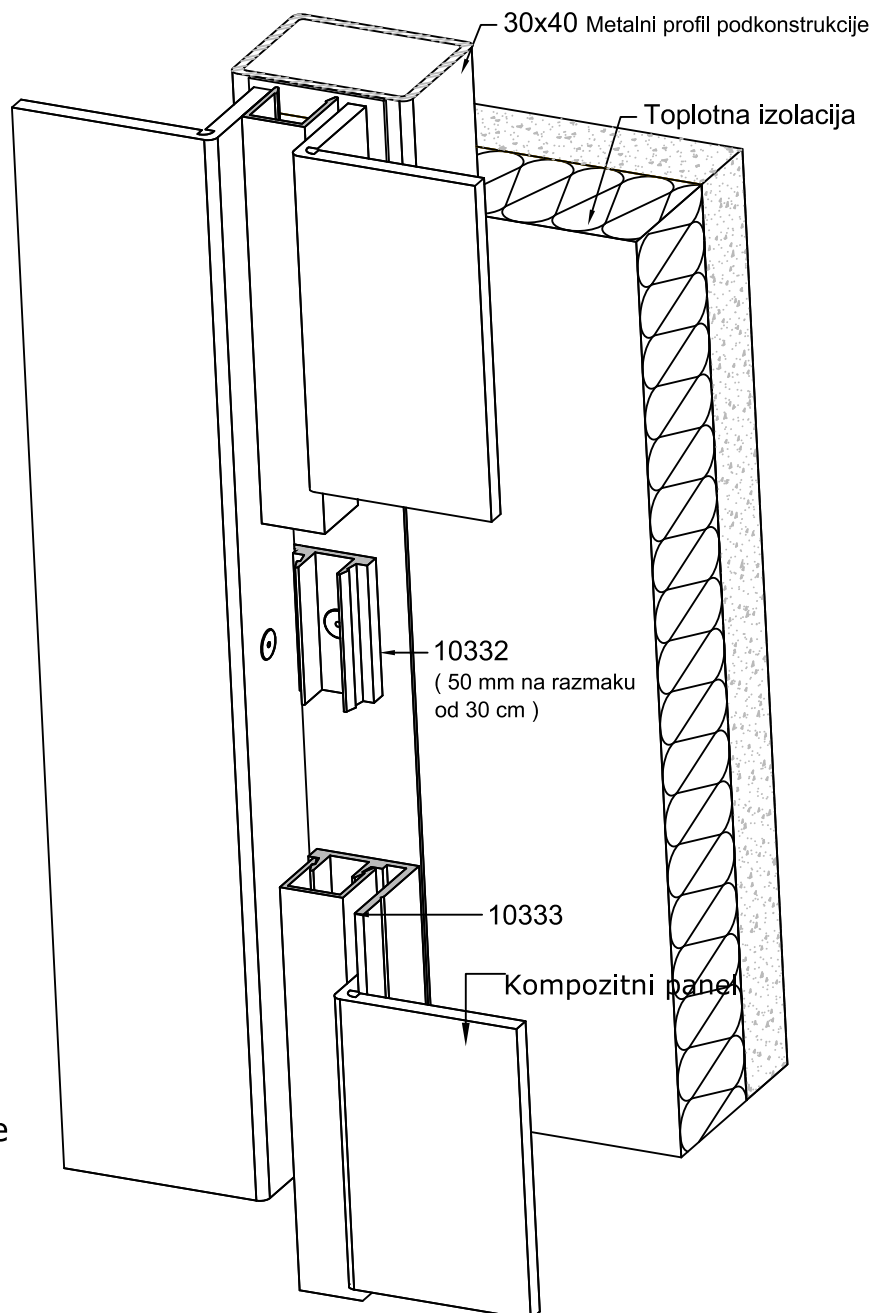
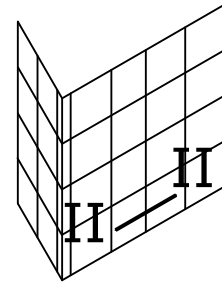
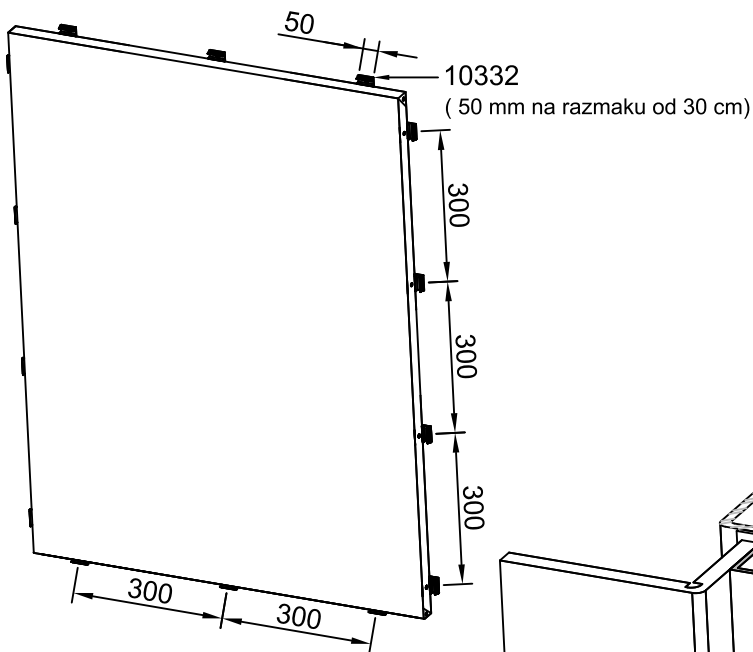

II-II Izgled iz perspektive

**Upozorenje:**

Debljina kompozitnih ploča i detalji za montažu moraju biti odabrani tako da zadovoljavaju statičke vrednosti visine zgrade i opterećenosti vetrom.

• Detalj

Sistem kompozitnih panela

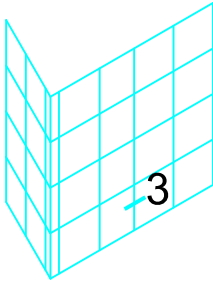

**Detalj 3**

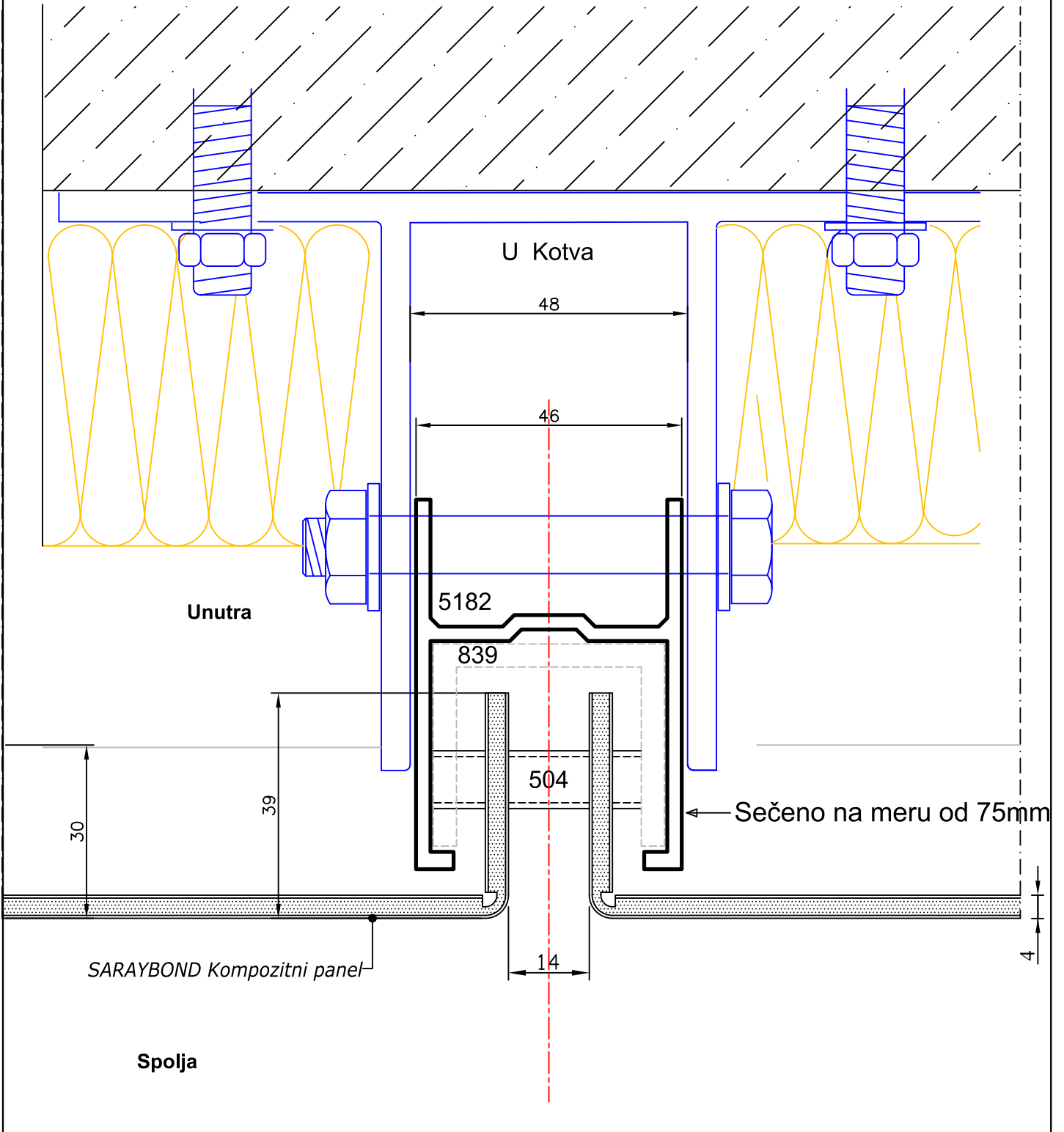

- Detalj

Sistem kompozitnih panela

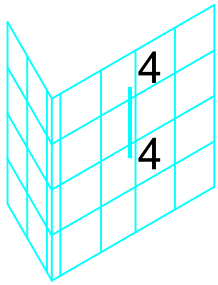

3544  
Nosač za nivelaciju

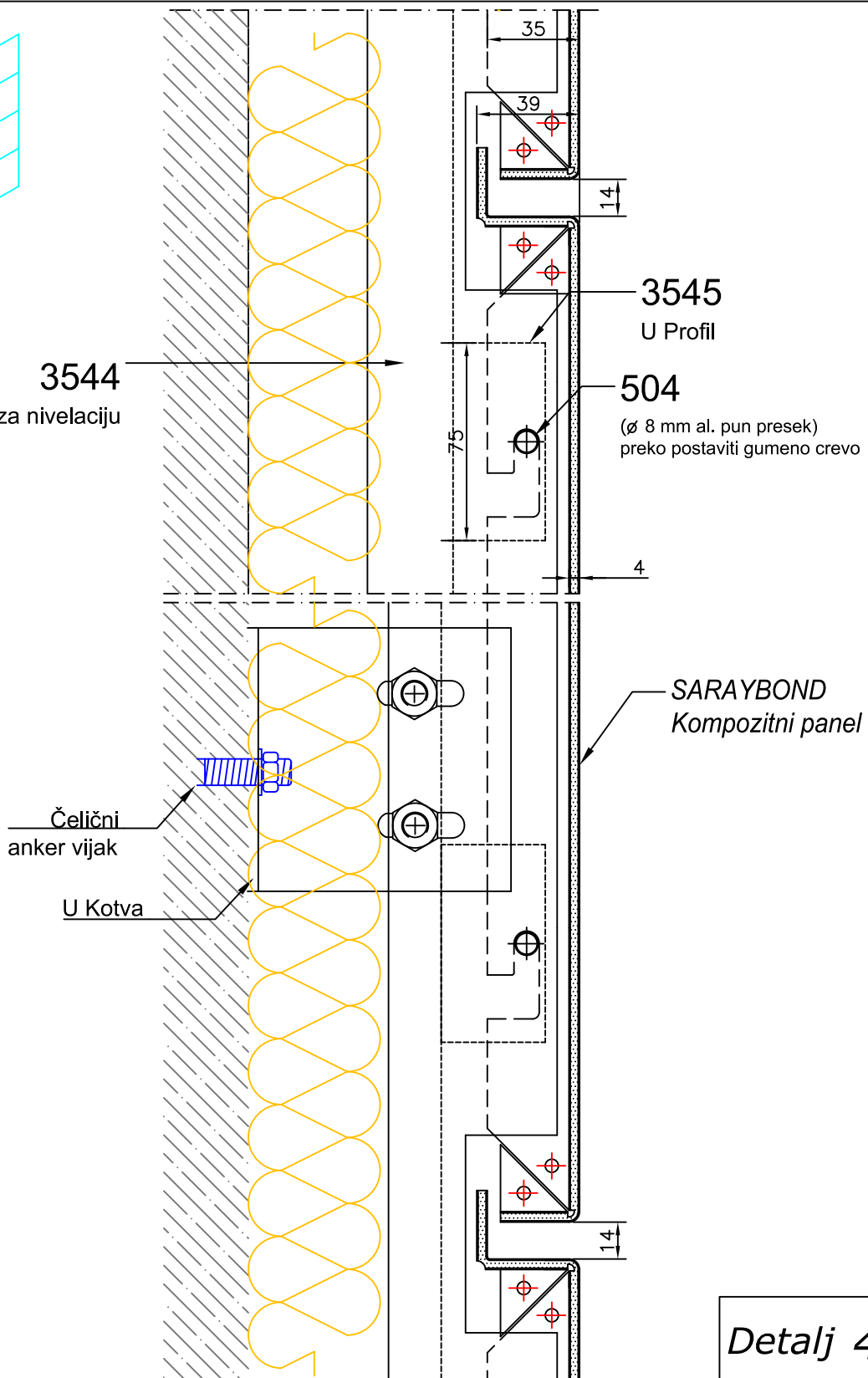

Razmera: 1 / 2.5

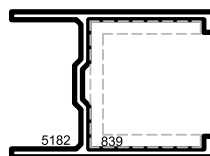

Sistem kompozitnih panela

• Detalji

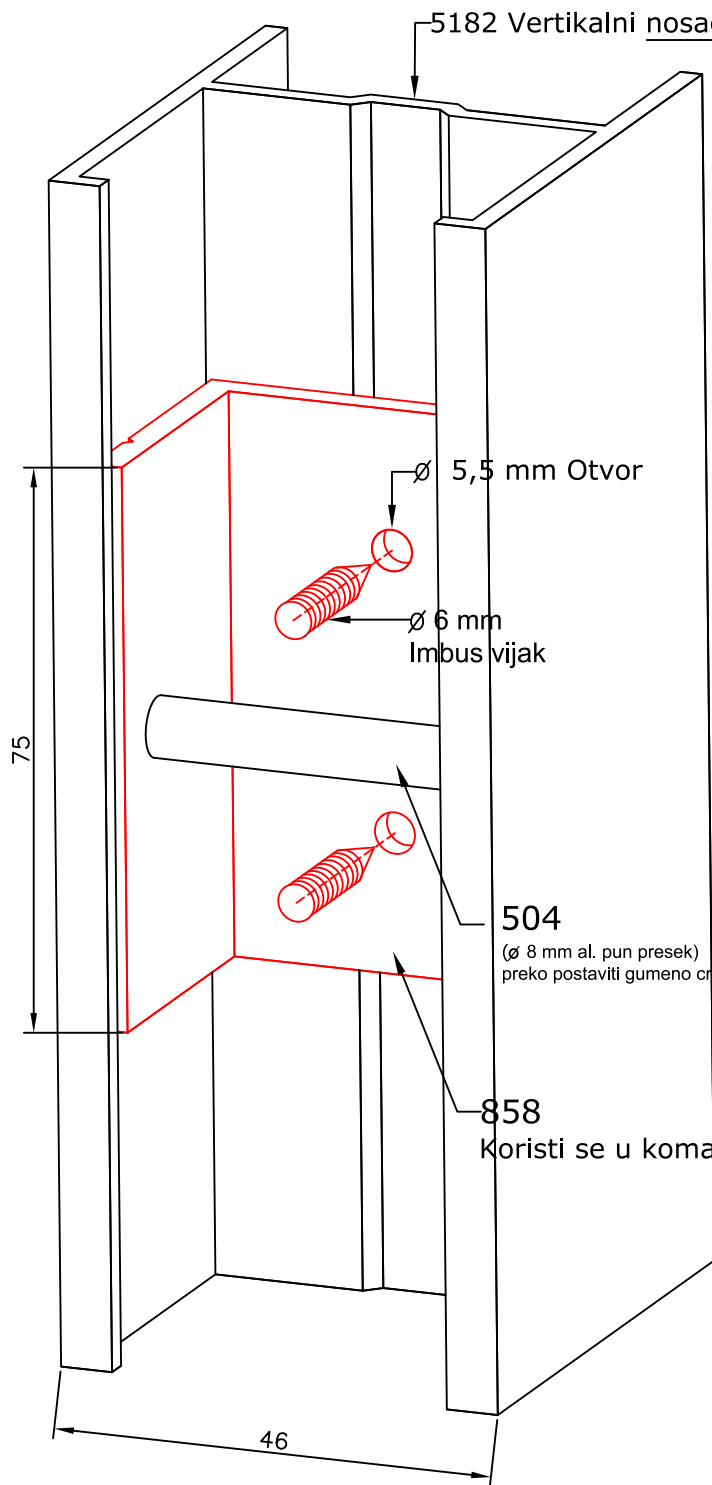

Izgled iz perspektive

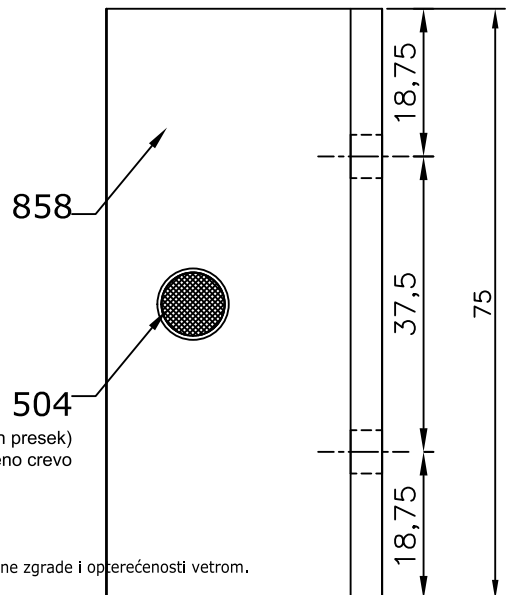
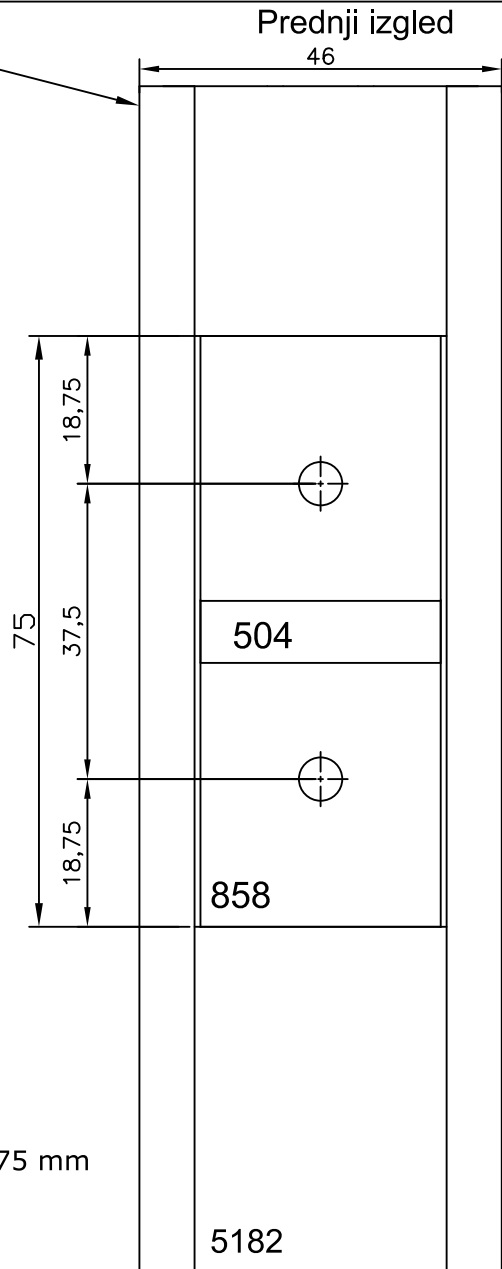

Upozorenje:

Debljina kompozitnih ploča i detalji za montažu moraju biti odabrani tako da zadovoljavaju statičke vrednosti visine zgrade i opterećenosti vetrom.

• Detalji

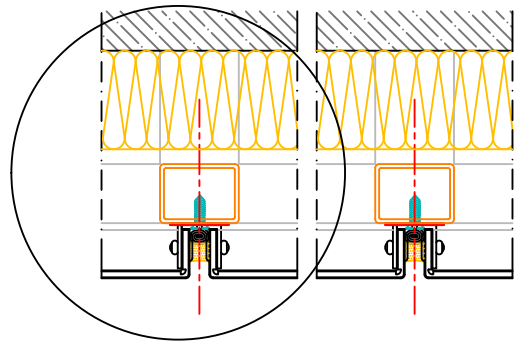
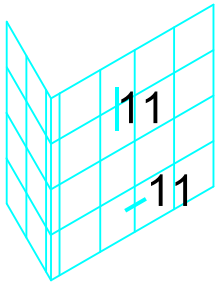

Detalj 11

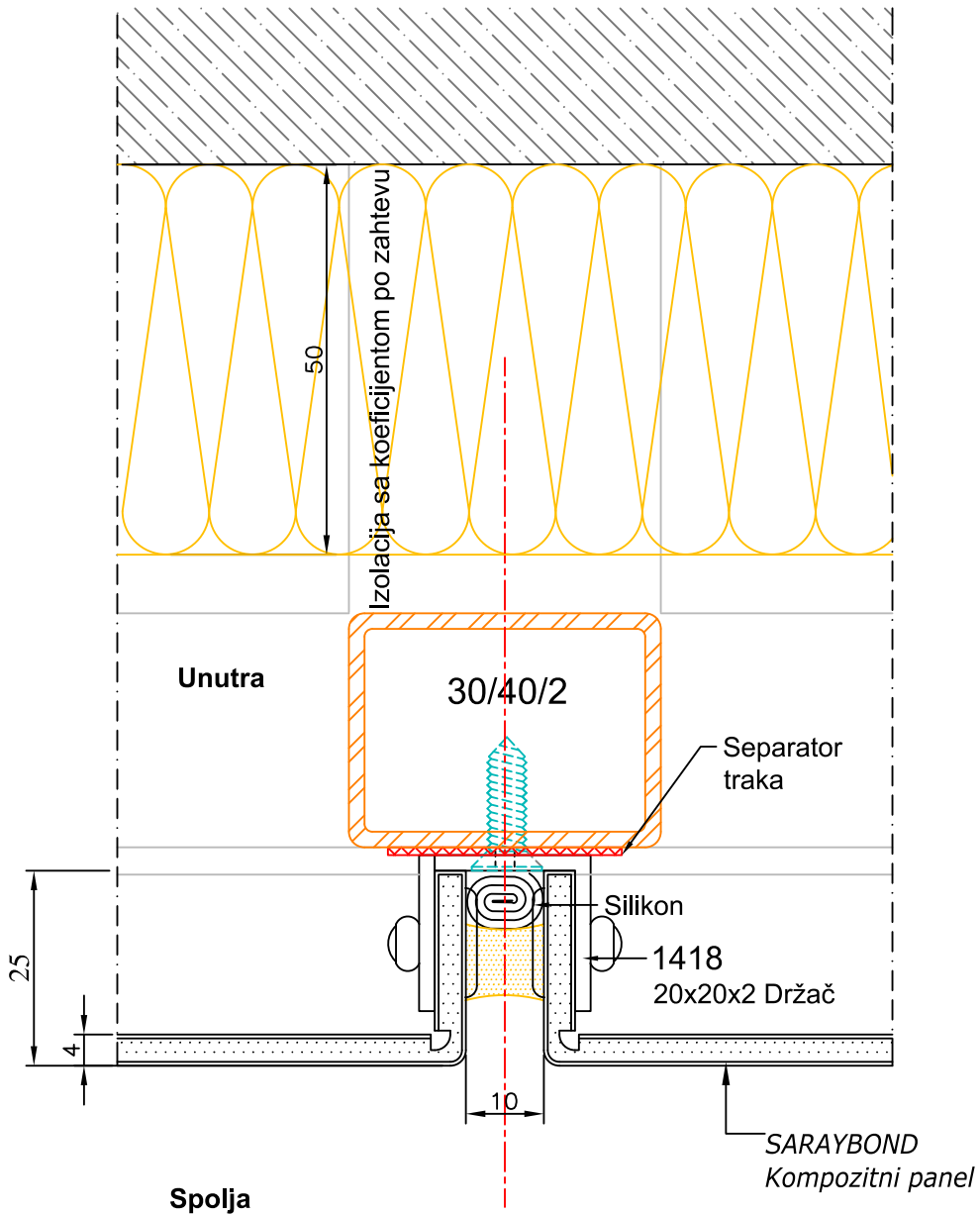

Upozorenje:

Debljina kompozitnih ploča i detalji za montažu moraju biti odabrani tako da zadovoljavaju statičke vrednosti visine zgrade i opterećenosti vetrom.

• Detalji

Unutra

**Detalj 9**

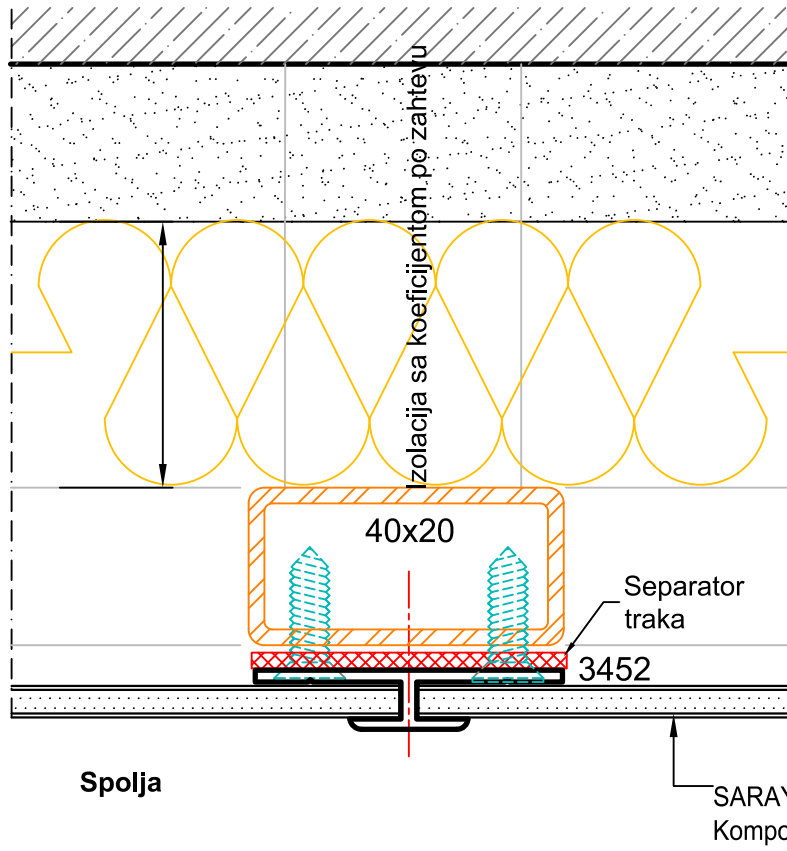

**Detalj 10**

