

**KATALOG**  
ALUMINIJUMSKE KONSTRUKCIJE  
SA TERMOPREKIDOM

CATALOGUE  
OF ALUMINIUM CONSTRUCTION  
WITH THERMAL BREAK

**PROAL**  
HH



ALH 62

KATALOG ALUMINIJUMSKE KONSTRUKCIJE  
SA TERMOPREKIDOM  
CATALOGUE OF ALUMINIUM CONSTRUCTION  
WITH THERMAL BREAK

Aluminijumski Prozorski Sistem  
Aluminium Window System

Detalji Sistema  
System Details

# ALH 62



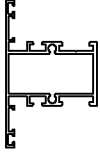
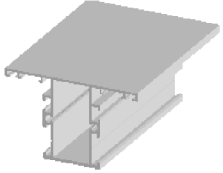
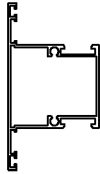
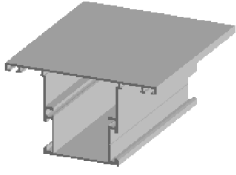
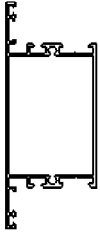
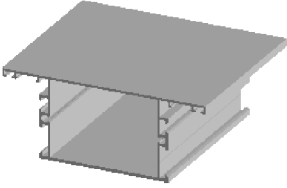
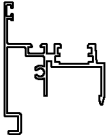
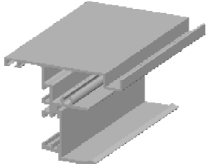
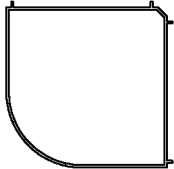
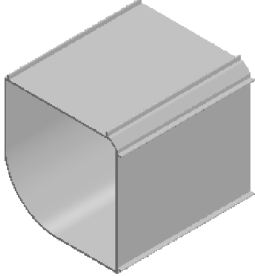
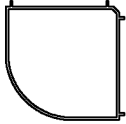
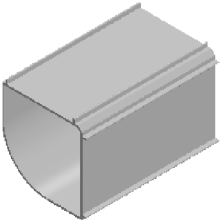

**PROFILI**

**PROFILES**

IZGLAD DESIGN	ŠIFRA CODE	3D PRIKAZ 3D VIEW	TEŽINA WEIGHT (kg/m)	Jxx (cm <sup>4</sup> )	Jyy (cm <sup>4</sup> )
	6210		0.716 Kg/m	4.69	10.14
	6212		0.883 Kg/m	6.15	14.58
	6214		1.150 Kg/m	10.80	28.17
	6221		1.090 Kg/m	5.41	16.77
	6225		1.146 Kg/m	13.06	36.52
	6223		1.360 Kg/m	23.96	32.62
	6224		1.166 Kg/m	13.62	35.57

IZGLED DESIGN	ŠIFRA CODE	3D PRIKAZ 3D VIEW	TEŽINA WEIGHT (kg/m)	Jxx (cm <sup>4</sup> )	Jyy (cm <sup>4</sup> )
	6231		1.150 Kg/m	12.45	12.50
	6232		1.030 Kg/m	12.32	18.75
	6235		1.550 Kg/m	20.13	58.06
	6241		0.973 Kg/m	7.73	11.64
	62 U1		1.227 Kg/m	44.53	56.56
	62 U2		0.862 Kg/m	14.62	19.71

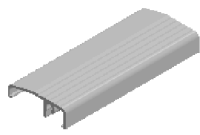
IZGLED DESIGN	ŠIFRA CODE	3D PRIKAZ 3D VIEW	TEŽINA WEIGHT (kg/m)	Jxx (cm <sup>4</sup> )	Jyy (cm <sup>4</sup> )
	6204		0.666 Kg/m	28.50	28.50
	6205		0.450 Kg/m	11.70	11.70
	6202		0.507 Kg/m	0.47	14.67
	6203		0.373 Kg/m	0.19	5.57
	6251		0.360 Kg/m	1.37	6.54
	6253		0.336 Kg/m	0.61	3.99

IZGLED DESIGN	ŠIFRA CODE	3D PRIKAZ 3D VIEW	TEŽINA WEIGHT (kg/m)	Jxx (cm <sup>4</sup> )	 Jyy (cm <sup>4</sup> )
	6201		0.369 Kg/m	0.16	2.40
	877		0.130 Kg/m	----	----

6210		
<b>JX</b> (cm <sup>4</sup> ) 4.69		<b>JY</b> (cm <sup>4</sup> ) 10.14
<b>TEŽINA / WEIGHT</b> (kg/m) 0.716		

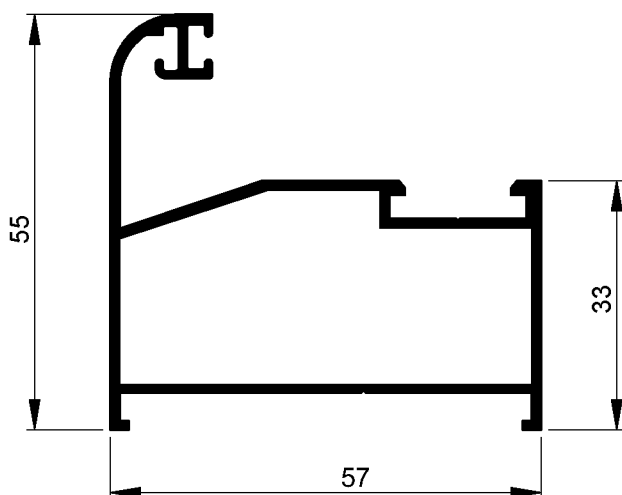
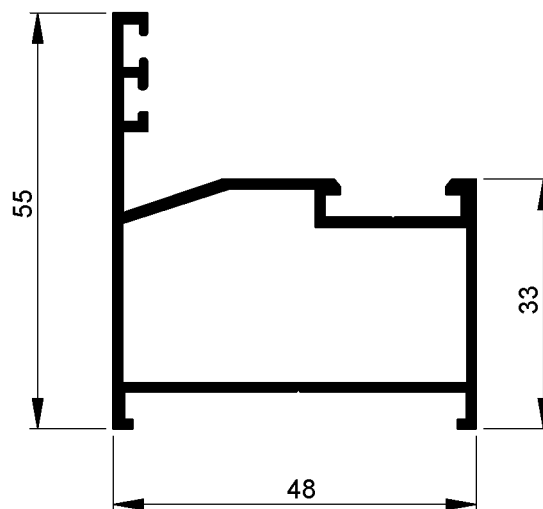

6212		
<b>JX</b> (cm <sup>4</sup> ) 6.15		<b>JY</b> (cm <sup>4</sup> ) 14.58
<b>TEŽINA / WEIGHT</b> (kg/m) 0.883		

6214		
<b>JX</b> (cm <sup>4</sup> ) 10.80		<b>JY</b> (cm <sup>4</sup> ) 28.17
<b>TEŽINA / WEIGHT</b> (kg/m) 1.150		

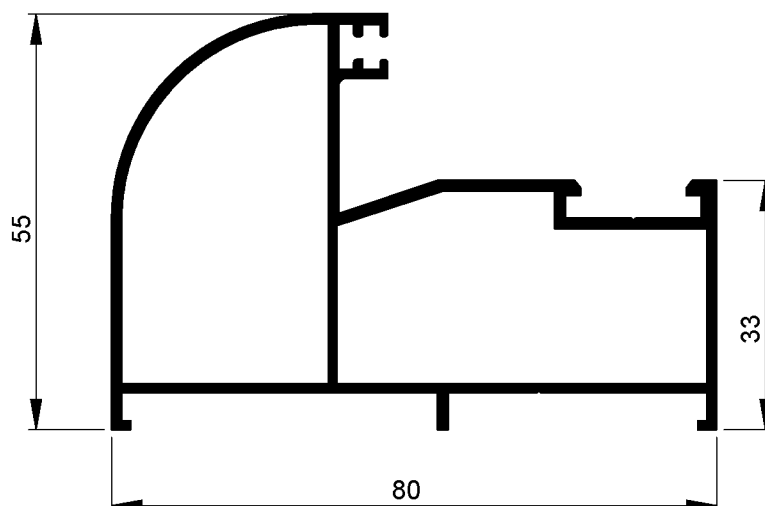

6221		
<b>JX</b> (cm <sup>4</sup> ) 5.41		<b>JY</b> (cm <sup>4</sup> ) 16.77
<b>TEŽINA / WEIGHT</b> (kg/m) 1.090		

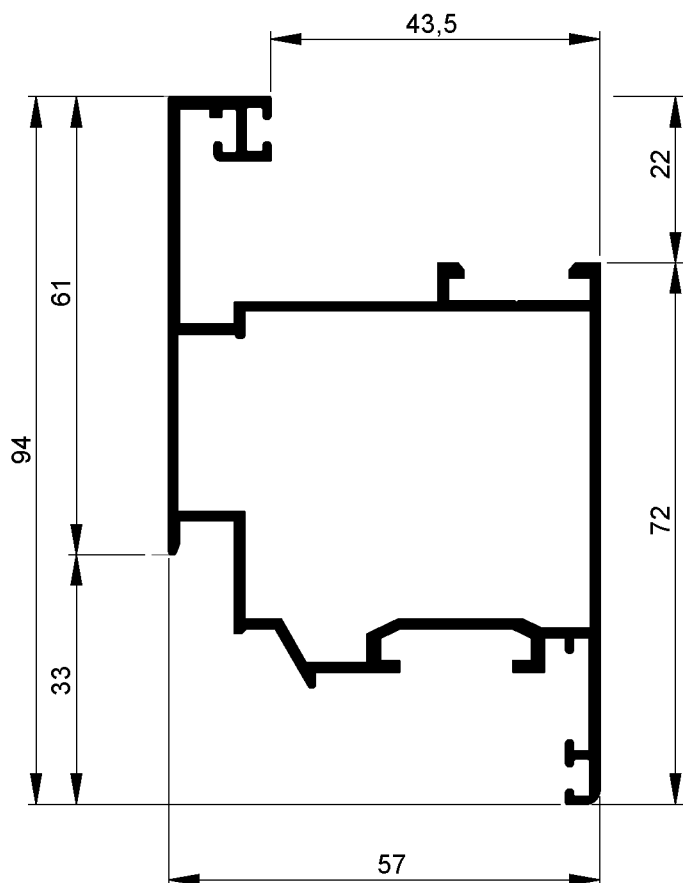
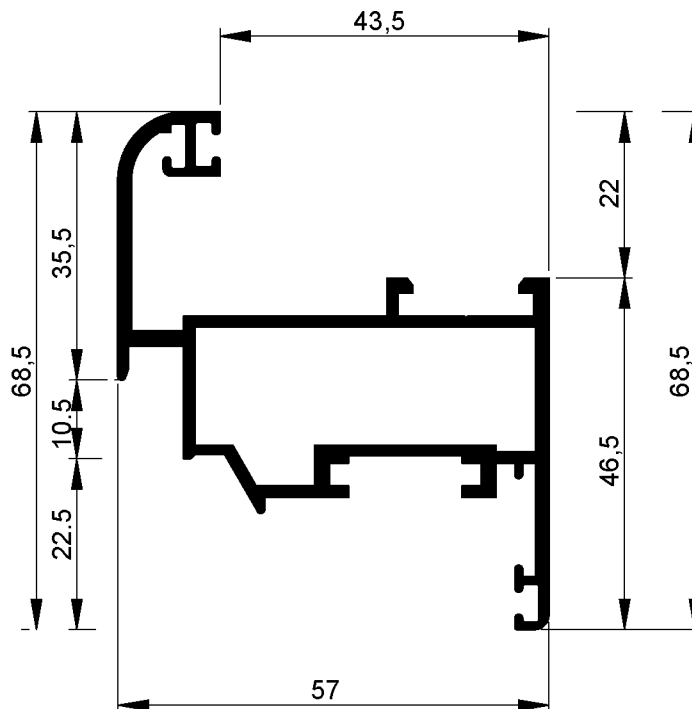

6225		
<b>JX</b> (cm <sup>4</sup> ) 13.06		<b>JY</b> (cm <sup>4</sup> ) 36.52
<b>TEŽINA / WEIGHT</b> (kg/m) 1.146		



6223		
<b>JX</b> (cm <sup>4</sup> ) 23.96		<b>JY</b> (cm <sup>4</sup> ) 32.62
<b>TEŽINA / WEIGHT</b> (kg/m) 1.360		

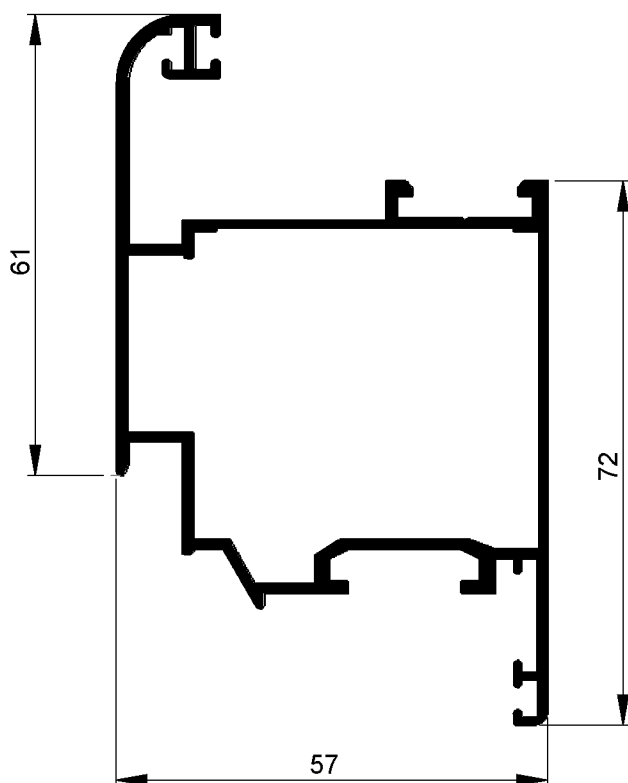
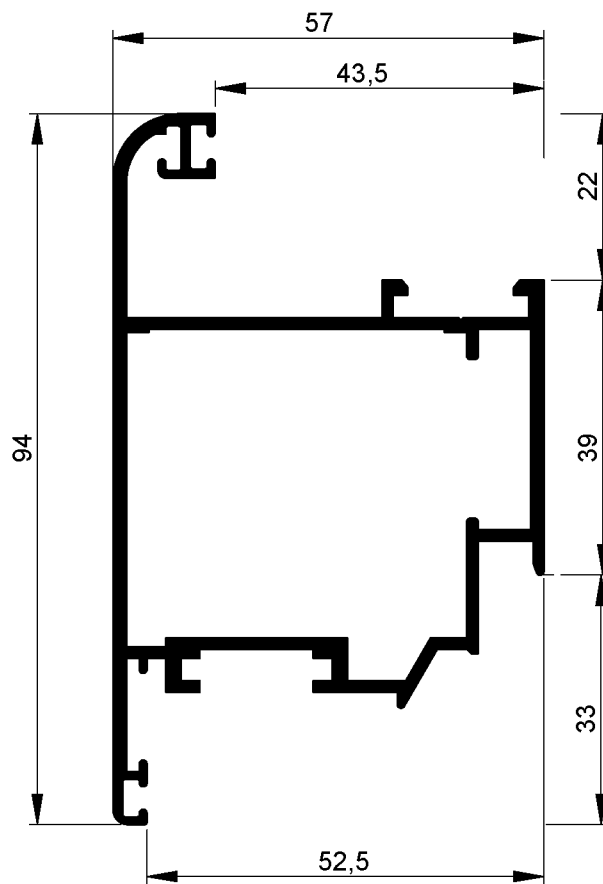

6224		
<b>JX</b> (cm <sup>4</sup> ) 13.62		<b>JY</b> (cm <sup>4</sup> ) 35.57
<b>TEŽINA / WEIGHT</b> (kg/m) 1.166		

6231		
<b>JX</b> (cm <sup>4</sup> )		<b>JY</b> (cm <sup>4</sup> )
12.45		12.50
<b>TEŽINA / WEIGHT</b> (kg/m)		
1.150		

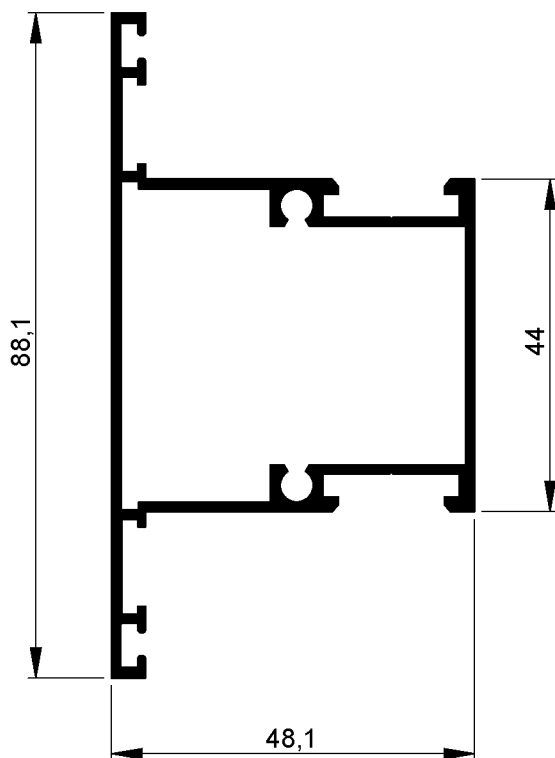
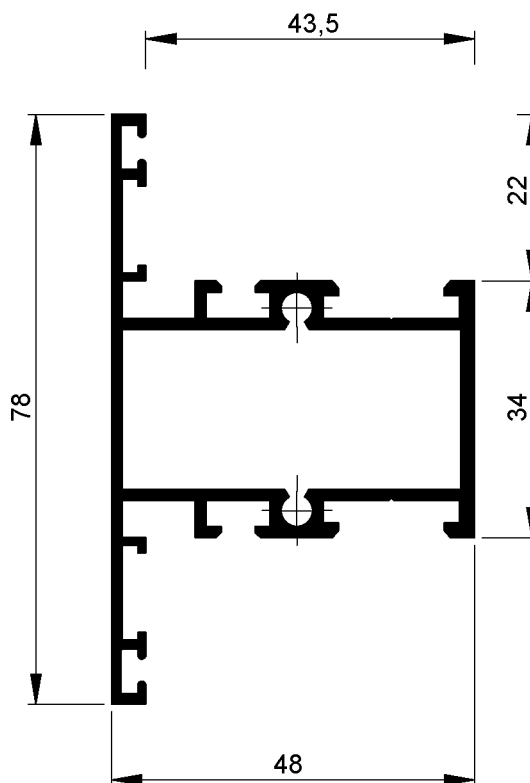

6232		
<b>JX</b> (cm <sup>4</sup> )		<b>JY</b> (cm <sup>4</sup> )
12.32		18.75
<b>TEŽINA / WEIGHT</b> (kg/m)		
1.030		

6235		
<b>JX</b> (cm <sup>4</sup> ) 20.13		<b>JY</b> (cm <sup>4</sup> ) 58.06
<b>TEŽINA / WEIGHT</b> (kg/m) 1.550		

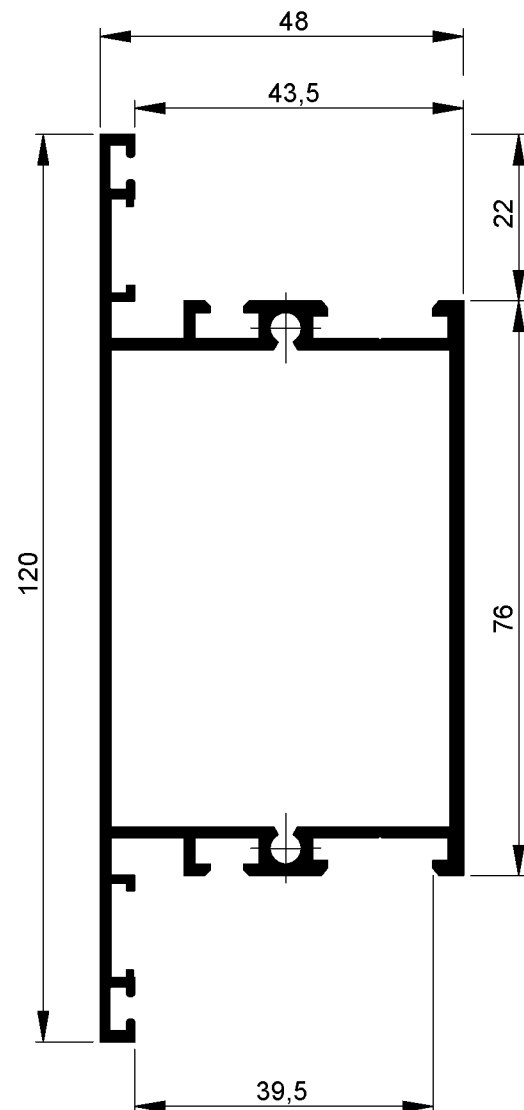

<b>6241</b>		
<b>JX</b> (cm <sup>4</sup> ) 7.73		<b>JY</b> (cm <sup>4</sup> ) 11.64
<b>TEŽINA / WEIGHT</b> (kg/m) 0.973		

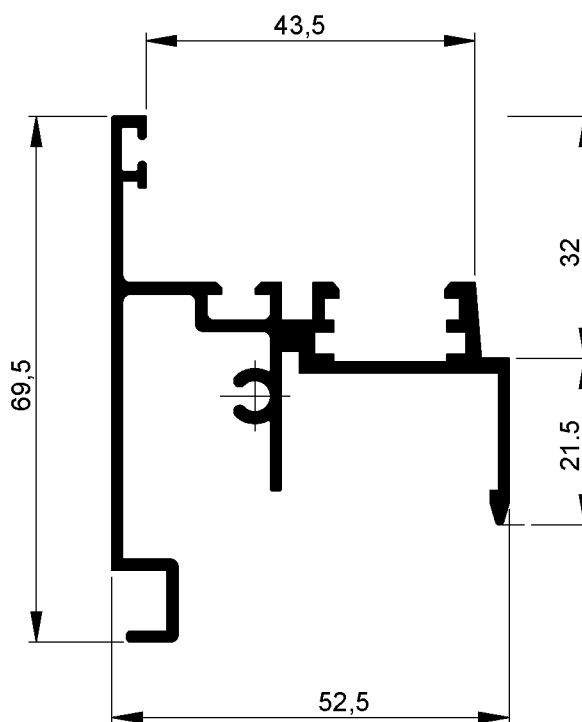

62 U1		
<b>JX</b> (cm <sup>4</sup> ) 44.53		<b>JY</b> (cm <sup>4</sup> ) 56.56
<b>TEŽINA / WEIGHT</b> (kg/m) 1.227		

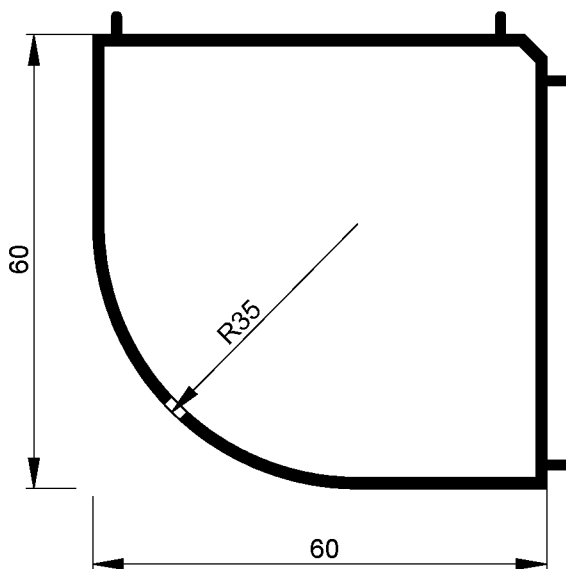
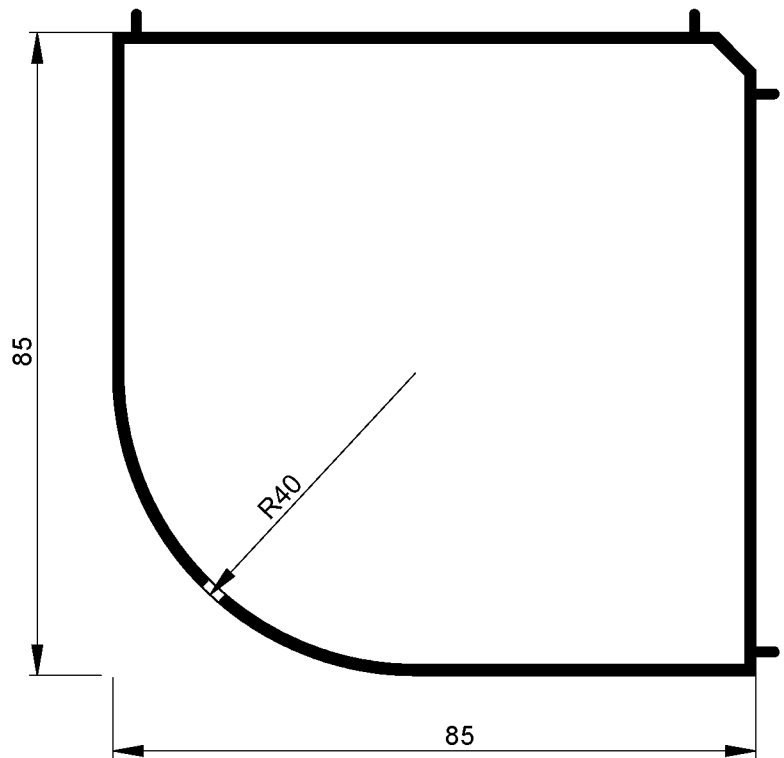

62 U2		
<b>JX</b> (cm <sup>4</sup> ) 14.62		<b>JY</b> (cm <sup>4</sup> ) 19.71
<b>TEŽINA / WEIGHT</b> (kg/m) 0.862		

6204		
<b>JX</b> (cm <sup>4</sup> ) 28.50		<b>JY</b> (cm <sup>4</sup> ) 28.50
<b>TEŽINA / WEIGHT</b> (kg/m) 0.666		

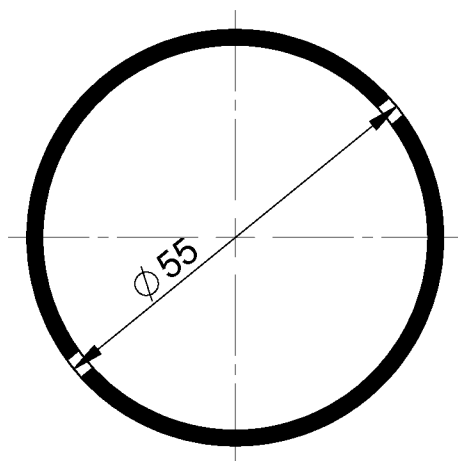
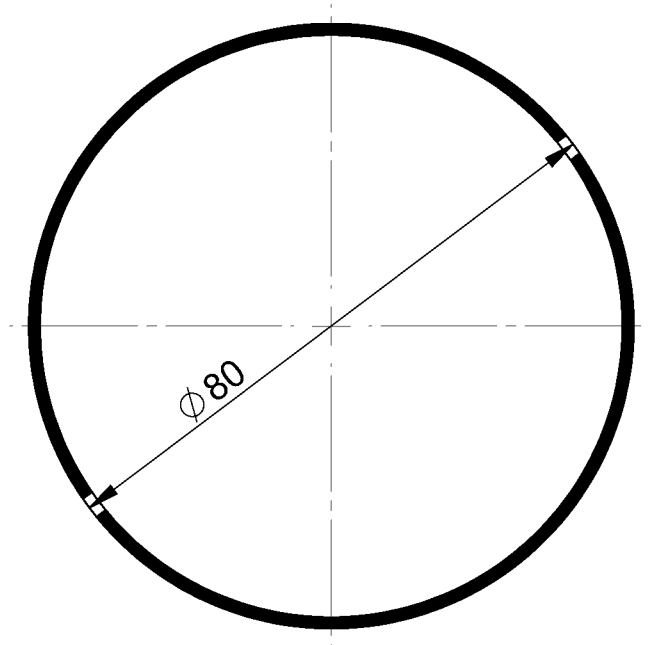

6205		
<b>JX</b> (cm <sup>4</sup> ) 11.70		<b>JY</b> (cm <sup>4</sup> ) 11.70
<b>TEŽINA / WEIGHT</b> (kg/m) 0.450		

6202		
<b>JX</b> (cm <sup>4</sup> ) 0.47		<b>JY</b> (cm <sup>4</sup> ) 14.67
<b>TEŽINA / WEIGHT</b> (kg/m) 0.507		

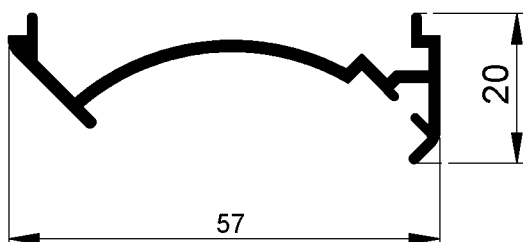
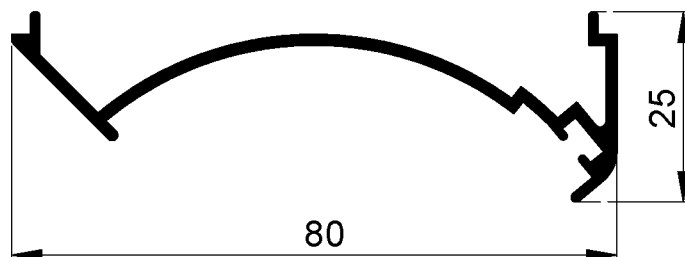

6203		
<b>JX</b> (cm <sup>4</sup> ) 0.19		<b>JY</b> (cm <sup>4</sup> ) 5.57
<b>TEŽINA / WEIGHT</b> (kg/m) 0.373		

6251		
<b>JX</b> (cm <sup>4</sup> ) 1.37		<b>JY</b> (cm <sup>4</sup> ) 6.54
<b>TEŽINA / WEIGHT</b> (kg/m) 0.360		

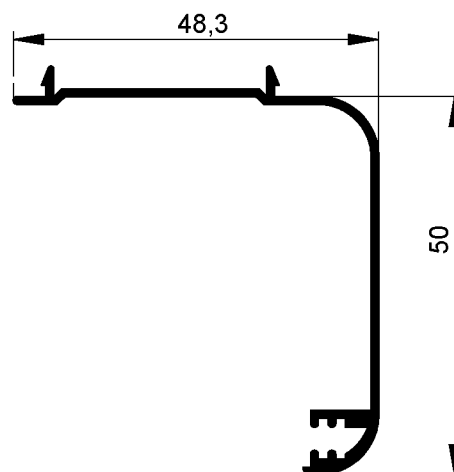

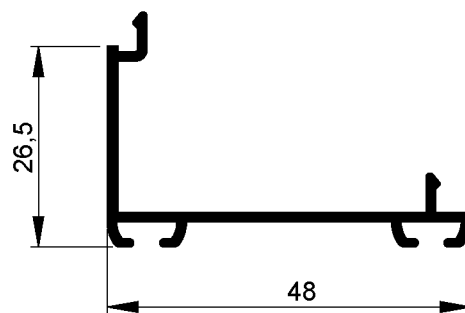

6253		
<b>JX</b> (cm <sup>4</sup> ) 0.61		<b>JY</b> (cm <sup>4</sup> ) 3.99
<b>TEŽINA / WEIGHT</b> (kg/m) 0.336		

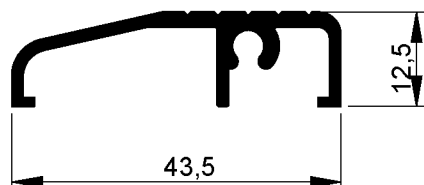

6201		
<b>JX</b> (cm <sup>4</sup> ) 0.16		<b>JY</b> (cm <sup>4</sup> ) 2.40
<b>TEŽINA / WEIGHT</b> (kg/m) 0.369		

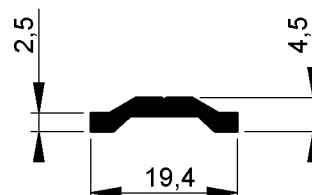

877		
<b>JX</b> (cm <sup>4</sup> ) ---		<b>JY</b> (cm <sup>4</sup> ) ---
<b>TEŽINA / WEIGHT</b> (kg/m) 0.130		



ŠIFRA CODE	TEŽINA (kg/m) WEIGHT	L m ↔	
<b>4706</b>	0.300	6	
<b>872</b>	0.250	6	
<b>1836</b>	0.230	6	

## 4706

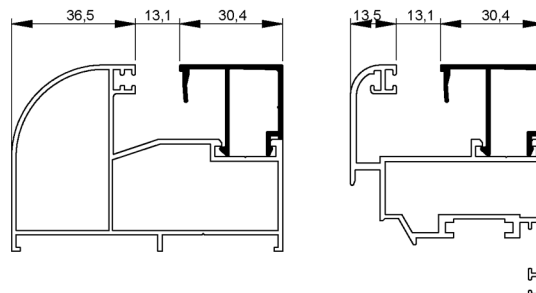
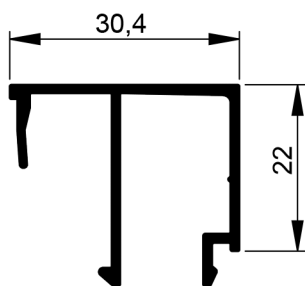

## 872

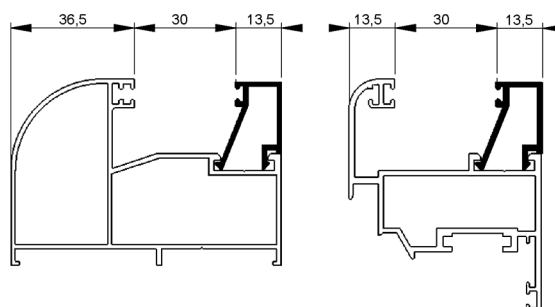
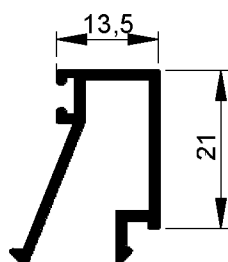

## 1836

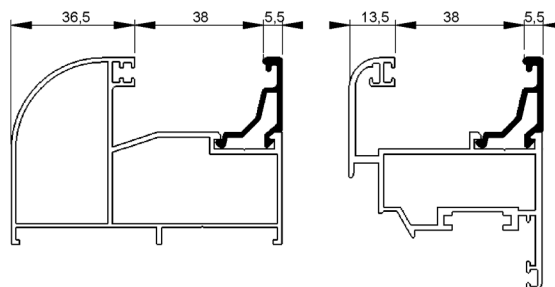
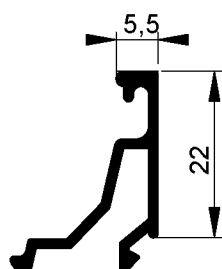

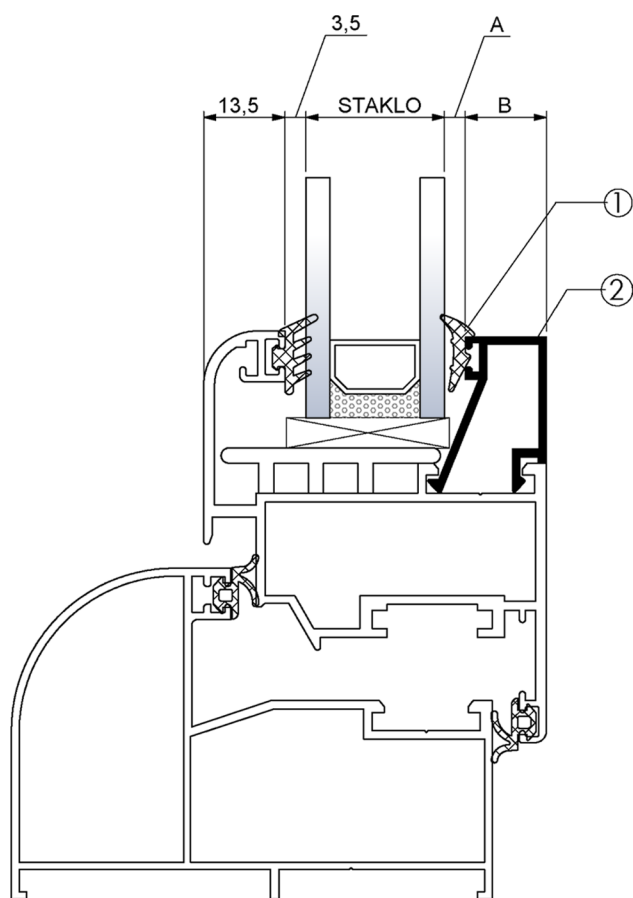

STAKLO GLASS	EPDM GUMA EPDM RUBBER	LAJSNA GLAZING BEAD PROFILE		
		mm	A:mm	①
4mm	4mm	P007	30mm	4706
6mm	2mm	P225	30mm	4706
20mm	4mm	P007	13.5mm	872
24mm	2mm	P225	13.5mm	872
32mm	3mm	P2007	5.5mm	1836

1.5 -2mm	3 -4mm	5 -6mm	Spoljna guma
P225	P007	P228	P031

KATALOG ALUMINIJUMSKE KONSTRUKCIJE  
SA TERMOPREKIDOM  
CATALOGUE OF ALUMINIUM CONSTRUCTION  
WITH THERMAL BREAK

Aluminijumski Prozorski Sistem  
Aluminium Window System

Detalji Sistema  
System Details

# ALH 62

**DETALJI**

**DETAILS**



